

**MAUS Analysis User System
User Guide**

Contents

| | | |
|----------|--|-----------|
| 1 | What Who and How? | 6 |
| 1.1 | Who Should Use MAUS | 6 |
| 1.2 | Getting the Code and Installing MAUS | 6 |
| 1.3 | Citing MAUS | 6 |
| 1.4 | Running MAUS | 7 |
| 1.4.1 | Run Control | 7 |
| 1.4.2 | Other Applications | 8 |
| 1.4.3 | Choosing the Unpacker Version | 8 |
| 1.5 | Accessing Data | 8 |
| 1.5.1 | Loading ROOT Files in Python Using PyROOT | 8 |
| 1.5.2 | Loading ROOT Files in C++ Compiled Analysis Code | 9 |
| 1.5.3 | Loading ROOT Files on the ROOT Command Line | 9 |
| 2 | Using and Modifying the Data Structure | 11 |
| 2.1 | Metadata | 11 |
| 2.2 | The Spill Datastructure | 13 |
| 2.3 | Image Datastructure | 14 |
| 2.4 | Accessing ROOT files | 15 |
| 2.5 | Conversion to, and Working With, JSON | 15 |
| 2.6 | Extending the Data Structure | 15 |
| 2.6.1 | Pointer Handling | 16 |
| 3 | Introduction to the MAUS API | 18 |
| 3.1 | Motivation | 18 |
| 3.2 | Everything starts with a 'Module' | 18 |
| 3.3 | Inheritance | 19 |
| 3.4 | Data Mangling | 19 |
| 3.5 | Module Initialisation and Destruction | 19 |
| 3.6 | Global Objects - Objects for Many Modules | 20 |
| 3.6.1 | Global Object Initialisation | 20 |
| 3.7 | Internal Classes | 20 |
| 3.7.1 | Abstraction Layers | 20 |
| 3.7.2 | C++ Python Wrapper | 21 |
| 3.7.3 | Data Mangling | 21 |

| | | |
|----------|--|-----------|
| 4 | Running the Monte Carlo | 22 |
| 4.1 | Beam Generation | 22 |
| 4.1.1 | Beam Polarisation | 23 |
| 4.1.2 | Amplitude Momentum Correlation | 23 |
| 4.2 | Getting the Right Answer | 23 |
| 4.2.1 | Geometry | 29 |
| 4.2.2 | Tracking | 29 |
| 4.2.3 | Energy Deposition and Showering | 29 |
| 4.3 | GEANT4 Bindings | 30 |
| 5 | Geometry | 36 |
| 5.1 | Geometry Download | 37 |
| 5.2 | Using the Geometry Download Executables | 38 |
| 6 | How to Define a Geometry | 42 |
| 6.0.1 | Configuration File | 42 |
| 6.0.2 | Module Files | 44 |
| 6.0.3 | Volume and Dimensions | 44 |
| 6.0.4 | Properties | 45 |
| 6.0.5 | Child Modules | 45 |
| 6.0.6 | Module Hierarchy and GEANT4 Physical Volumes | 45 |
| 6.0.7 | A Sample Configuration File | 46 |
| 6.0.8 | A Sample Child Module File | 47 |
| 7 | Geometry and Tracking MiceModule Properties | 48 |
| 7.1 | General Properties | 48 |
| 7.2 | Sensitive Detectors | 48 |
| 7.2.1 | Scintillating Fibre Detector (SciFi) | 49 |
| 7.2.2 | Cerenkov Detector (CKOV) | 49 |
| 7.2.3 | Time Of Flight Counter (TOF) | 49 |
| 7.2.4 | Special Virtual Detectors | 49 |
| 7.2.5 | Virtual Detectors | 49 |
| 7.2.6 | Envelope Detectors | 50 |
| 7.3 | Unconventional Volumes | 52 |
| 7.3.1 | Trapezoid Volume | 52 |
| 7.3.2 | Volume Wedge | 52 |
| 7.3.3 | Volume Polycone | 52 |
| 7.3.4 | Volume Quadrupole | 52 |
| 7.3.5 | Volume Multipole | 53 |
| 7.3.6 | Volume Boolean | 53 |
| 7.3.7 | Volume Sphere | 54 |
| 7.4 | Repeating Modules | 54 |
| 7.5 | Beam Definition and Beam Envelopes | 55 |
| 7.6 | Optimiser | 58 |
| 8 | Field Properties | 60 |
| 8.0.1 | FieldType CylindricalField | 60 |
| 8.0.2 | FieldType RectangularField | 60 |
| 8.0.3 | FieldType Solenoid | 61 |
| 8.0.4 | FieldType FieldAmalgamation | 61 |

| | | |
|-----------|---|-----------|
| 8.0.5 | FieldType DerivativesSolenoid | 62 |
| 8.0.6 | Phasing Models | 62 |
| 8.0.7 | Tracking Stability Around RF Cavities | 63 |
| 8.0.8 | FieldType PillBox | 63 |
| 8.0.9 | FieldType RFFieldMap | 63 |
| 8.0.10 | FieldType Multipole | 64 |
| 8.0.11 | FieldType CombinedFunction | 65 |
| 8.0.12 | EndFieldTypes | 65 |
| 8.0.13 | FieldType MagneticFieldMap | 66 |
| 9 | TOF Detector | 69 |
| 9.1 | Simulation | 69 |
| 9.1.1 | Digitization | 70 |
| 9.2 | Reconstruction | 70 |
| 9.3 | Database | 73 |
| 10 | The Trackers | 74 |
| 10.1 | Introduction | 74 |
| 10.1.1 | Overview | 74 |
| 10.1.2 | Quick start guide | 74 |
| 10.2 | Definitions | 75 |
| 10.2.1 | Labelling of upstream and downstream trackers | 75 |
| 10.2.2 | Station numbering | 75 |
| 10.2.3 | Doublet layer | 76 |
| 10.2.4 | Fibre-channel numbering | 76 |
| 10.3 | Reference surfaces and coordinate systems | 79 |
| 10.3.1 | Doublet layer | 79 |
| 10.3.2 | Station | 79 |
| 10.3.3 | Tracker | 80 |
| 10.3.4 | Coordinate transformations | 80 |
| 10.4 | Reconstruction Algorithms | 80 |
| 10.4.1 | Hits and clusters | 80 |
| 10.4.2 | Space-point reconstruction | 82 |
| 10.4.3 | Pattern recognition | 84 |
| 10.4.4 | Track fit | 90 |
| 10.5 | Data structure | 90 |
| 10.6 | Code Design | 90 |
| 10.6.1 | General Code Structure | 90 |
| 10.6.2 | Tracker configuration variables | 95 |
| 10.7 | The Monte Carlo | 96 |
| 10.7.1 | Station Geometry | 96 |
| 10.7.2 | MC VLPC Dark Count | 96 |
| 10.7.3 | Building Digits | 96 |
| 11 | Global PID | 97 |
| 11.1 | Introduction | 97 |
| 11.1.1 | Using the PID scripts | 97 |
| 11.1.2 | Producing PDFs | 97 |
| 11.2 | MapCppGlobalPID and ReduceCppGlobalPID | 100 |
| 11.2.1 | MapCppGlobalPID | 100 |

| | | |
|-----------|---|------------|
| 11.3 | ReduceCppGlobalPID | 101 |
| 11.4 | PID Variables | 102 |
| 11.4.1 | PID Base Class | 102 |
| 11.4.2 | PID Variable Classes | 102 |
| 12 | The Envelope Tool | 104 |
| 12.1 | Example Usage | 104 |
| 12.2 | Envelope Tool main window | 104 |
| 12.3 | Beam Setup | 104 |
| 12.4 | Magnet Setup | 105 |
| 12.5 | Plot Setup | 106 |
| 13 | G4beamline-MAUS Integration | 107 |
| 14 | Appendix C: Tracker Appendices | 109 |
| 14.1 | Kuno's Conjecture | 109 |
| 14.2 | Space-point variance | 110 |
| 14.3 | Circle parameters from three points | 113 |
| 14.4 | Helical Track Pattern Recognition | 115 |

Chapter 1

What Who and How?

MAUS (MICE Analysis User Software) is the MICE project's tracking, detector reconstruction and accelerator physics analysis framework. MAUS is designed to fulfil a number of functions for physicists interested in studying MICE data:

- Model the behaviour of particles traversing MICE
- Model the MICE detector's electronics response to particles
- Perform pattern recognition to reconstruct particle trajectories from electronics output
- Provide a framework for high level accelerator physics analysis
- Provide online diagnostics during running of MICE

In addition to MAUS's role within MICE, the code is also used for generic accelerator development, in particular for the Neutrino Factory.

1.1 Who Should Use MAUS

MAUS is intended to be used by physicists interested in studying the MICE data. MAUS is designed to function as a general tool for modelling particle accelerators and associated detector systems. The modular system, described in the API section, makes MAUS suitable for use by any accelerator or detector group wishing to perform simulation or reconstruction work.

1.2 Getting the Code and Installing MAUS

Installation is described in a separate document, available at <http://micewww.pp.rl.ac.uk/projects/maus/wiki/Install>

1.3 Citing MAUS

MAUS should be cited according to the guidelines in the file `CITATION`.

1.4 Running MAUS

MAUS contains several applications to perform various tasks. Two main applications are provided. `bin/simulate_mice.py` makes a Monte Carlo simulation of the experiment and `bin/analyze_data_offline.py` reconstructs an existing data file. Start a clean shell and move into the top level MAUS directory. Then type

```
> source env.sh
> ${MAUS_ROOT_DIR}/bin/simulate_mice.py
> ${MAUS_ROOT_DIR}/bin/analyze_data_offline.py
```

1.4.1 Run Control

The routines can be controlled by a number of settings that enable users to specify run configurations, as specified in this document. Most control variables can be controlled directly from the command line, for example doing

```
> ${MAUS_ROOT_DIR}/bin/simulate_mice.py \
    --simulation_geometry_filename Test.dat
```

to run the Monte Carlo against a given geometry. As another example, it is possible to run the data reconstruction against a given run

```
> cd ${MAUS_ROOT_DIR}
> ${MAUS_ROOT_DIR}/bin/analyze_data_offline.py \
    --daq_data_file 02873 \
    --daq_data_path src/input/InputCppDAQData
```

This will run against data in run 02873 looking for files in directory `src/input/InputCppDAQData`.

To get a (long) list of all command line variables use the `-h` switch.

```
> ${MAUS_ROOT_DIR}/bin/simulate_mice.py -h
```

More complex control variables can be controlled using a configuration file, which contains a list of configuration options.

```
> ${MAUS_ROOT_DIR}/bin/simulate_mice.py --configuration_file config.py
```

where a sample configuration file for the example above might look like

```
simulation_geometry_filename = "Test.dat"
```

Note that where on the command line a tag like `--variable value` was used, in the configuration file `variable = "value"` is used. In fact the configuration file is a python script. When loaded, MAUS looks for variables in its variable list and loads them in as configuration options. Other variables are ignored. This gives users the full power of a scripting language while setting up run configurations. For example, one might choose to use a different filename,

```
import os
simulation_geometry_filename = os.path.join(
    os.environ["MICEFILES"]
    "Models/Configurations/Test.dat"
)
```

This configuration will then load the file at `$MICEFILES/Models/Configurations/Test.dat`

The default configuration file can be found at `src/common_py/ConfigurationDefaults.py` which contains a list of all possible configuration variables and is loaded by default by MAUS. Any variables not specified by the user are taken from the configuration defaults.

1.4.2 Other Applications

There are several other applications in the `bin` directory and associated sub-directories.

- `bin/examples` contains example scripts for accessing a number of useful features of the API
- `bin/utilities` contains utility functions that perform a number of useful utilities to do with data manipulation, etc
- `bin/user` contains analysis functions that our users have found useful, but are not necessarily thoroughly tested or documented
- `bin/publications` contains analysis code used for writing a particular (MICE) publication

1.4.3 Choosing the Unpacker Version

The unpacker is the third party library shipped with MAUS used to unpack the MICE DAQ binary data. It comes in two versions, one for Step I data and one for Step IV data. The current default unpacker version is Step I. In order to switch unpacker versions, set up the MAUS environment, and run the script `switch_unpacker.bash` in the MAUS root directory supplying either `StepI` or `StepIV` as an argument, depending on the unpacker needed. This will then build the correct unpacker, clean and rebuild MAUS, modify `env.sh` and test the new configuration.

1.5 Accessing Data

By default, MAUS writes data as a ROOT file. ROOT is a widely available high energy physics data analysis library, available from `'http://root.cern.ch'` and prepacked with the MAUS third party libraries. Two techniques are foreseen for accessing the data, either using PyROOT python interface or using a compiled C++ binary. Some mention of ROOT cint scripting tools is made below, but this is not supported by MAUS developers beyond the most basic usage.

1.5.1 Loading ROOT Files in Python Using PyROOT

The standard scripting tool in MAUS is python. The ROOT data structure can be loaded in python using the PyROOT package. An example of how to perform a simple analysis with PyROOT is available in `bin/examples/load_root_file.py`. This example runs the reconstruction code to produce an output data file ``${MAUS_ROOT_DIR}/tmp/example_load_root_file.root` and then runs a toy analysis that plots digits at TOF1 for plane 0 and plane 1. This example produces two histograms, `tof1_digits_0_load_root_file.png` and `tof1_digits_1_load_root_file.png`.

1.5.2 Loading ROOT Files in C++ Compiled Analysis Code

The ROOT data structure can be loaded in C++ by compiling the Make file found in `bin/examples/load_root_file_cpp/Makefile`. This compiles the sample analysis in `bin/examples/load_root_file_cpp/load_root_file.cc`. For example,

```
$ source env.sh
$ cd ${MAUS_ROOT_DIR}/bin/examples
$ python load_root_file.py
$ cd ${MAUS_ROOT_DIR}/bin/examples/load_root_file_cpp/
$ make clean
$ make
$ ./load_root_file
```

This example performs a simple analysis against the data file generated by `load_root_file.py`, which is identical to the analysis performed by `load_root_file.py`. The executable produces two histograms, `tof1_digits_0_load_root_file_cpp.png` and `tof1_digits_1_load_root_file_cpp.png`; they should be identical to the histograms produced by `load_root_file.py`.

1.5.3 Loading ROOT Files on the ROOT Command Line

One can load ROOT files from the command line using the ROOT interactive display. It is first necessary to load the MAUS class dictionary. Then The TBrowser ROOT GUI can be used to browse to the desired location and interrogate the data structure interactively. For example,

```
$ source env.sh
$ root
```

```
*****
*
*           W E L C O M E  t o  R O O T           *
*
*   Version   5.30/03   20 October 2011         *
*
*   You are welcome to visit our Web site      *
*           http://root.cern.ch                 *
*
*****
```

```
ROOT 5.30/03 (tags/v5-30-03041540, Oct 24 2011, 11:51:36 on linuxx8664gcc)
```

```
CINT/ROOT C/C++ Interpreter version 5.18.00, July 2, 2010
Type ? for help. Commands must be C++ statements.
Enclose multiple statements between { }.
root [0] .L $MAUS_ROOT_DIR/build/libMausCpp.so
root [1] TBrowser b
```

Note: ROOT infrastructure can only be used to plot data nested within up to two dynamic arrays. Data nested in three or more dynamic arrays is beyond the capabilities of ROOT interactive plotting tools; explicit loops over the data are required in a PyROOT script or C++ code. In general, working through the ROOT command line or ROOT macros is notoriously unreliable and is not supported by the MAUS development team; it is useful as a basic check of data integrity and no more.

More information on the data is available in the data structure chapter 2.

Chapter 2

Using and Modifying the Data Structure

MAUS operates on data in discrete blocks, primarily spills, with one spill representing the particle burst generated by one dip of the MICE target. Additionally, MAUS can write data into a JobHeader, RunHeader, RunFooter and JobFooter data type. Histograms for plotting in online mode are encoded into an Image data type. The top level branch in the data tree inherits from MAUSEvent<T>, defined in `src/common_cpp/DataStructure/MAUSEvent.hh` (C++) with type identified by `GetEventType()` string; in JSON the top level branch always has a `maus_event_type` member which is a string value corresponding to the output of `MAUSEvent<T>::GetEventType()`. A summary of configuration cards affecting Input, Output and data structure is shown below.

2.1 Metadata

Job metadata is stored in JobHeader and JobFooter data structures. (Data) Run metadata is stored in RunHeader and RunFooter data structures. The JobHeader is created at the start and end of an execution of the code and stores data on datacards, bsr state and so forth. The RunHeader is created at the start of each run and stores per run metadata such as the calibrations and cablings used. One RunHeader and RunFooter is written for each process in the entire *transform* and *merge* execution structure; so in multithreading mode this would yield one RunHeader and RunFooter for each Celery subprocess (which runs the Input/Transform) and an additional RunHeader and RunFooter for the merge/output process. In single threaded mode a single RunHeader and RunFooter is generated. The RunFooter and JobFooter are created at the end of the run and store run and job summary information. For more details on writing to these metadata types and multithreading modes, please see the section on API.

The Metadata is stored in ROOT in trees separate to the main Spill data tree. In JSON, these data are stored as separate lines often at the start and end of the run, and distinguished by the `maus_event_type` branch in the root. The structure of a MAUS output file is shown below.

Table 2.1: I/O control variables.

| Name | Meaning |
|---|---|
| <code>input_root_file_name</code> | Set the file name used for reading input files by <code>InputCppRoot</code> module |
| <code>output_root_file_name</code> | Set the file name used for writing output files by <code>OutputCppRoot</code> module |
| <code>end_of_run_output_root_directory</code> | Set target directory for end of run file placement. The user must ensure that this directory exists or MAUS will throw an exception. |
| <code>output_root_file_mode</code> | Controls how root files are handled across multiple run numbers. Set to <code>one_big_file</code> to put everything into one big file with file name given by <code>output_root_file_name</code> . Set to <code>one_file_per_run</code> to split the filename by the trailing <code>‘.’</code> and insert the run number, for each run. For example, <code>output.root</code> would become <code>output_999.root</code> for run number 999. Set to <code>end_of_run_file_per_run</code> to place in a directory specified by <code>end_of_run_output_root_directory</code> . Data from each run will be placed in a sub-directory specified by the run number, and a file specified by the <code>output_root_file_name</code> within that directory. MAUS will create the run number directory if one does not exist but not the <code>end_of_run_output_root_directory</code> . So in the example above, if <code>end_of_run_output_root_directory</code> is <code>end_of_run</code> files will be placed like <code>./end_of_run/999/output.root</code> |
| <code>input_json_file_name</code> | Set the file name used for reading input files by <code>InputPyJSON</code> module |
| <code>input_json_file_type</code> | Set to <code>gzip</code> to read input from a gzipped file; set to <code>text</code> to read input from a plain text file |
| <code>output_json_file_name</code> | Set the file name used for writing output files by <code>OutputPyJSON</code> module |
| <code>output_json_file_type</code> | Set to <code>gzip</code> to write output as a gzipped file; set to <code>text</code> to write output as a plain text file |
| <code>header_and_footer_mode</code> | Set to <code>append</code> to write out job and run headers and footers; set to <code>dont_append</code> to suppress this output. |

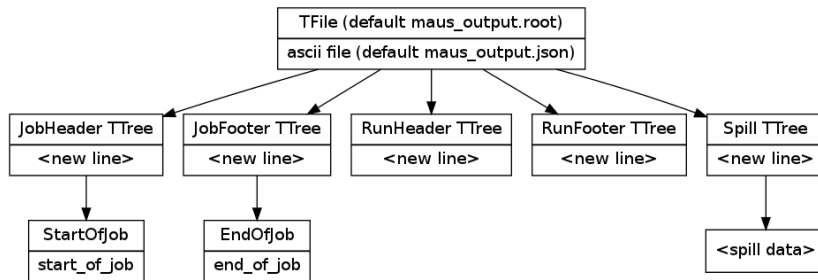

Figure 2.1: The MAUS file structure including metadata. The top label in each box describes the representation in C++/ROOT. The bottom label describes the representation in JSON.

2.2 The Spill Datastructure

The major part of the MAUS data structure therefore is a tree of which each entry corresponds to the data associated with one spill. The spill is separated into three main sections: the MCEventArray contains an array of data each member of which represents the Monte Carlo of a single primary particle crossing the system; the ReconEventArray contains an array of data each member of which corresponds to a particle event (i.e. set of DAQ triggers); and the DAQData corresponds to the raw data readout. Additionally there are branches for reconstructed scalars, which are handled spill by spill and EMR data, which also read out on the spill rather than event by event.

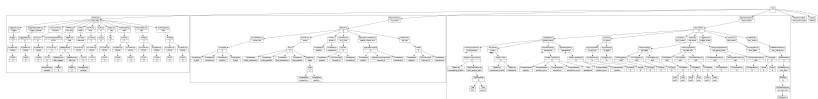

Figure 2.2: The MAUS output structure for a spill event. The top label in each box is the name of the C++ class and the bottom label is the json branch name. If a [] is shown, this indicates that child objects are array items.

The MCEvent is subdivided into sensitive detector hits and some pure Monte Carlo outputs. The primary that led to data being created is held in the Primary branch. Here the random seed, primary position momentum and so forth is stored. Sensitive detector hits have Hit data (energy deposited, position, momentum, etc) and a detector specific ChannelId that represents the channel of the detector that was hit - e.g. for TOF this indexes the slab, plane and station. Virtual hits are also stored - these are not sensitive detector hits, rather output position, momenta etc of particles that cross a particular plane in space, time or proper time is recorded. Note virtual hits do not inherit from the Hit class and have a slightly different data structure.

The ReconEvent and DAQEvents are subdivided by detector. ReconEvents contain reconstructed particle data for each detector and the trigger. There is an additional branch that contains global reconstruction output, that is the track fitting between detectors.

The data can be written in two formats. The main data format is a ROOT

binary format. This requires the ROOT package to read and write, which is a standard analysis/plotting package in High Energy Physics and is installed by the MAUS build script. The secondary data format is JSON. This is an ascii data-tree format that in principle can be read by any text editor. Specific JSON parsers are also available - for example, the python *json* module is available and comes prepackaged with MAUS.

2.3 Image Datastructure

There is a final data type that MAUS handles, the Image type. The Image data structure is written by ReducePyMatplotHistogram and ReducePyROOTHistogram data types. Image data is only available in JSON format. The data structure is shown in Fig. 2.3.

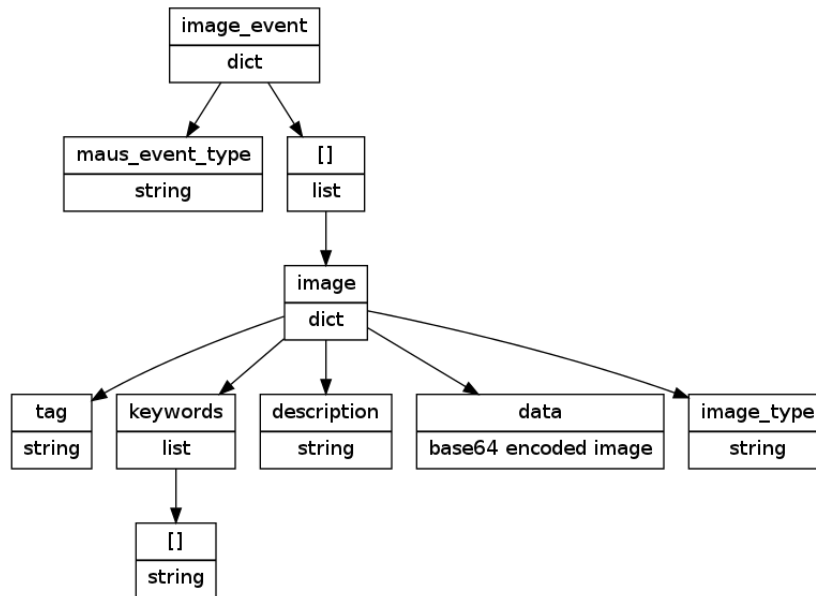

Figure 2.3: The MAUS output structure for an Image event. The top label in each box is the name of the JSON branch and the bottom label is the data type. If a [] is shown, this indicates that child objects are array items. Note there is no C++ implementation of Image events

Each document contains a `maus_event_type` that should always be `Image`, and a list of images; the image data is encoded as a base 64 image and other data associated with the image is stored alongside. The `tag` names the image, while `image_type` describes the data format (png, jpeg, etc). `OutputPyImage` stores data with `image_type.tag` as the file name. `description` contains a description of the file and `keywords` describes a list of key phrases that can be used when searching.

2.4 Accessing ROOT files

For details on how to access the ROOT files, please see the introduction section of this document.

2.5 Conversion to, and Working With, JSON

MAUS also provides output in the JSON data format. This is an ascii format with IO libraries available for C++, Python and other languages. Two utilities are provided to perform conversions, `bin/utilities/json_to_root.py` and `bin/utilities/root_to_json.py` for conversion from and to JSON format respectively. JSON Input and Output modules are provided, `InputPyJson` and `OutputPyJson`.

An example json analysis is available in `bin/examples/load_json_file.py/`

2.6 Extending the Data Structure

The data structure can be extended in MAUS by adding extra classes to the existing data structure. The data classes are in `src/common_cpp/DataStructure`. In order to make these classes accessible to ROOT, the following steps must be taken:

- Add a new class in `src/common_cpp/DataStructure`.
- Ensure that default constructor, copy constructor, equality operator and destructor is present. The destructor must be virtual.
- Add `#include "src/common_cpp/Utils/VersionNumber.hh"` and a call to the `MAUS_VERSIONED_CLASS_DEF()` macro at the end of the class definition before the closing braces. `MAUS_VERSIONED_CLASS_DEF` calls the `ROOT ClassDef()` macro which generates metaclasses based on information in the class. This is put into the (dynamically generated) `MausDataStructure.h,cc` files.
- Add the class to the list of classes in `src/common_cpp/DataStructure/LinkDef.hh`. This is required for the class to be linked properly to the main library, and a linker error will result if this step is not taken.
- Add any template definitions which you used, including STL classes (e.g. `std::vector<MyClass>` or whatever) to `linkdef`. Otherwise ROOT will generate a segmentation fault whenever the user tries to call functions of the templated class (but the code will link successfully in this case).

In order to make these classes accessible to JSON, it is necessary to add a new processor in `src/common_cpp/JsonCppProcessors`. There are a few default processors available.

- `src/common_cpp/JsonCppProcessors/ProcessorBase.hh` contains `IProcessor` pure interface class for all processors and `ProcessorBase` base class (which may contain some implementation)

- `src/common_cpp/JsonCppProcessors/PrimitivesProcessors.hh` contains processors for primitive types; `BoolProcessor`, `IntProcessor`, `UIntProcessor`, `StringProcessor`, `DoubleProcessor`
- `src/common_cpp/JsonCppProcessors/ArrayProcessors.hh` contains processors for array types. Two processors are available: `PointerArrayProcessor` which converts an STL vector of pointers to data; and `ValueArrayProcessor` which converts an STL vector of values to data.
- `src/common_cpp/JsonCppProcessors/ObjectProcessor.hh` contains a processor for object types. Most of the classes in the MAUS data structure are represented in JSON as objects (string value pairs) where each string names a branch and each value contains data, which may be another class.
- `src/common_cpp/JsonCppProcessors/ObjectMapProcessors.hh` contains a processor for converting from JSON objects to STL maps. This is useful for JSON objects that contain lots of branches all of the same type.

A script, `bin/user/json_branch_to_data_structure_and_cpp_processor.py` is available that analyses a JSON object or JSON tree of nested objects and converts to C++ classes. The script is provided "as-is" and it is expected that developers will check the output, adding comments and tests where appropriate.

2.6.1 Pointer Handling

MAUS can handle pointers for arrays and classes using ROOT native support (via the `TRef` and `TRefArray` classes) or the standard JSON reference syntax. JSON references are indexed by a path relative to the root value of a JSON document. JSON references are formatted like URIs, for example the JSON object `{"$ref": "#spill/recon_events/1"}` would index the second `recon_event` in the spill object (indexing from 0). MAUS can only handle paths relative to the top level of the JSON document for the same MAUS event. Absolute URIs, URIs relative to another position in the JSON document or URIs to another MAUS event are not supported.

In MAUS, it is necessary to make a distinction between data that is stored as a value in C++ and JSON (value-as-data), data that is stored as a pointer in C++ and a value in JSON (pointer-as-data) and data that is stored as a pointer in C++ and JSON to some other data in the same tree (pointer-as-reference). In the latter case, the C++ parent object does not own the memory; rather it is owned by some other object in the same tree and *borrowed* by the C++ object holding the pointer-as-reference. The `TRef` and `TRefArray` classes provide this functionality by default; never owning the memory but only storing a relevant pointer. All objects referenced by a `TRef` or `TRefArray` must inherit from `TObject`. ROOT handles all memory management while writing to and reading from ROOT files, and the order of reading is unimportant, as long as both reference and value have been read before the reference is used.

Pointers-as-data are converted between JSON arrays and C++ objects using the `ObjectProcessor<ParentType>::RegisterPointerBranch<ChildType>` method. This takes a Processor for the `ChildType` as an argument. For C++ arrays / vectors, the Processor argument is instead a `PointerArrayProcessor<ArrayContents>`.

Pointers-as-reference (`TRef` and `TRefArray`) are converted using the `ObjectProcessor<ParentType>::Register` and `ObjectProcessor<ParentType>::RegisterTRefArray` methods respectively.

Other equivalent data formats, for example YAML, use a unique identifier to reference a pointer-as-reference and store the pointer-as-data in a reserved part of the data tree. There are some consequences of storing pointers-as-reference using the path to a pointer-as-data as implemented in MAUS.

- The user must specify which data is the primary data source (pointer-as-data) and which data is a cross reference (pointer-as-reference).
- Pointers-as-reference are position dependent. If the associated pointer-as-data is moved the pointer-as-reference can no longer be resolved. For example, inserting an element into an array can cause misalignment of pointers-as-reference.
- Pointer data will always be available at the location of the pointer-as-data in the JSON tree, even when using a parser that is not pointer aware.
- A unique identifier type algorithm can be implemented as a relatively simple extension of the data format outlined here; but it is relatively hard to extend a unique identifier algorithm to reference existing parts of the data tree.

Pointer Resolution

Conversion from C++ pointers to JSON pointers is handled in a type-safe way. Values-as-data are stored in the data tree converted at run time from JSON to C++ and vice versa. Pointers-as-data are handled in the same way as Values-as-data. Pointers-as-references are stored in the C++ data tree as a TRef (or TRefArray element) in the normal way, and in JSON as an address to the position in the tree to a pointer-as-data. It is an error to store a pointer-as-reference without storing an associated pointer-as-data as the pointer-as-reference cannot be converted, unless the pointer-as-reference is set to NULL (in which case it may be an error depending on caller settings). It is an error to store multiple C++ pointers-as-data to the same memory address as the conversion from C++ to JSON and back again would yield logically different data and the resolution of associated pointers-as-reference is dependent on the resolution order of the data tree, which is ill-defined.

In order to implement the data conversion, the pointers have to be resolved in a two-stage process. In the first stage, it is necessary to collect all of the pointers-as-data and pointers-as-reference by traversing the data tree. This is performed during the standard data conversion, but pointers-as-reference are left pointing to NULL. A mapping from the pointer-as-data in the original data format to the pointer-as-data in the converted data format is stored, together with a list of pointers-as-reference in the original data format and the necessary mutators in the converted data format. In the second stage MAUS iterates over the pointers-as-reference, finds the appropriate pointer-as-data and writes the location of the pointer-as-data to the pointer-as-reference in the converted data format. The code is templated to maintain full type-safety during this process.

Chapter 3

Introduction to the MAUS API

This chapter introduces the MAUS API framework and looks in depth at the structure of the classes and interfaces that it comprises of. Several example *minimal* implementations are given before a note on scalability and extending the framework.

3.1 Motivation

The MAUS API framework provides MAUS developers with a well-defined environment for developing reconstruction code, while allowing independent development of the backend and code sharing of common elements like error handling and data mangling.

3.2 Everything starts with a ‘Module’

An *Module* is the basic building block of the MAUS API framework. Four types of module exist within MAUS.

- An Input module is used to create an instance of a MAUS Spill structure.
- An Output module is used to store an instance of a MAUS data structure.
- A Map module is used to modify a single Spill item. This enables the reconstruction to be parallelised across multiple Maps.
- A Reduce module is used to act on a collection of Spills.

Every module has a constructor, destructor, a birth and a death method. Input modules have an emitter function that yields a new data object. Output modules have a save function that takes a data object and stores it (either on disk, or for example broadcasting across a socket).

Map modules and Reduce modules have a process function that takes a data object and modifies it. The important difference is that Map modules have no internal state, meaning that they can be run in parallel. Reduce modules, on

the other hand, do have internal state. This means that they can act on groups of Spills, for example collecting histogram data.

3.3 Inheritance

In order to correctly make a module, one should inherit from the correct type.

- Input modules should inherit from `InputBase`.
- Output modules should inherit from `OutputBase`.
- Map modules should inherit from `MapBase`.
- Reduce modules should inherit from `ReduceBase`.

Base types are defined in `src/common_cpp/API` for C++ modules and `src/common_py/API` for python modules.

3.4 Data Mangling

MAUS supports representation of the data structure in various different formats. MAUS support representation in ROOT, ascii string and json formats. It is recommended that reconstruction routines use the ROOT format. For legacy reasons, MAUS supports reconstruction of data stored in ascii or json formats.

In python, the representation (i.e. format) of the data can be changed by using the module `maus_cpp.converter`. If a module implements conversion to a specific data type, the `can_convert` flag should be set to `True`; otherwise MAUS will always hand data in string format.

In C++, mappers are templated to a MAUS data type. The API then handles any necessary conversion to that data type, and provides the appropriate python wrapper code for that module.

Currently only map modules support data mangling.

3.5 Module Initialisation and Destruction

MAUS has two execution concepts. A `Job` refers to a single execution of the code, while a `Run` refers to the processing of data for a MICE data run or Monte Carlo run.

In MAUS, `Inputters`, `Mappers`, `Reducers` and `Outputters` are initialised at the start of every `Job` and destructed at the end of every `Job`. `birth(...)` for `Inputters` and `Outputters` is called at the start of every `Job` and `death()` is called at the end of every `Job`. The `birth(...)` for `Mappers` and `Reducers` is called at the start of every `Run` and `death()` is called at the end of every `Run`.

The logic is that for each code execution we typically want to access data from a single data source and output data to a single data file. But mappers and reducers are reinitialised for each run to enable loading of new calibrations, etc. It is required that all transient information about the reconstruction pertaining to a run - particularly ID of the calibration and cabling used - is recorded in the `StartOfRun` data structure. Any summary information on code execution

during the run may be stored in the EndOfRun data structure. All transient information pertaining to a job - for example code version or bzr branch - should be recorded in the StartOfJob data structure. Any summary information on code execution during the job may be stored in the EndOfJob data structure.

3.6 Global Objects - Objects for Many Modules

There are some objects that sit outside the scope of the modular framework described above. Typically these are objects that do not belong to any one module, but need to be accessed by many. Examples are the logging functionality (Squeak), ErrorHandler, Configuration datacards, field maps, geometry description and Geant4 interfaces. These are accessed through the static singleton class `Globals` defined in `src/common_cpp/Utils/Globals.hh`. Initialisation is handled in `src/common_cpp/Globals/GlobalsManager.hh`. One `Globals` instance is initialised per subprocess when running in multiprocessing mode.

For python users, some Global objects can be accessed by reference to the `maus_cpp.globals` module.

3.6.1 Global Object Initialisation

Global objects are initialised before any modules in `Go.py` and deleted after all modules are dead. Global object initialisation and destruction is handled at the Job level by `src/common_cpp/Globals/GlobalManager.hh` and called in python via `maus_cpp.globals` as above.

Run-by-run initialisation is handled by the `RunActionManager`, defined in `src/common_cpp/Utils/RunActionManager.hh`. The `RunActionManager` holds a list of objects inheriting from `RunActionBase` each of which defines functions to call at the start and end of each run.

3.7 Internal Classes

The following classes and namespaces are used to provide an interface between reconstruction modules and the framework (backend).

3.7.1 Abstraction Layers

These are all defined in `src/common_cpp/API` and `src/common_py/API` folders

- `IModule` - interface class for all modules; defines `birth` and `death`
- `ModuleBase` - base class for modules, includes some error handling.
- `IInput` - interface class for all inputs; defines `emitter` and inherits from `IModule`
- `InputBase` - base class for all inputs, includes some error handling and inherits from `ModuleBase` and `IInput`
- `IMap` - interface class for all inputs; defines `process` and inherits from `IModule`

- `MapBase` - base class for all inputs, includes some error handling and inherits from `ModuleBase` and `IMap`
- `IReduce` - interface class for all reducers; defines `process` and inherits from `IModule`
- `ReduceBase` - base class for all reducers, includes some error handling and inherits from `ModuleBase` and `IReduce`
- `IOutput` - interface class for all outputs; defines `save` and inherits from `IModule`
- `OutputBase` - base class for all outputs, includes some error handling and inherits from `ModuleBase` and `IOutput`

3.7.2 C++ Python Wrapper

`src/common_cpp/API/PyWrapMapBase` is a templated class that wraps a generic map object and provides python interfaces to that map object.

Currently, Input, Reduce, Output wrappers are provided by SWIG.

3.7.3 Data Mangling

Data mangling is handled in a variety of layers.

- `src/common_cpp/Converter/ConverterBase` provides an abstraction for conversion from one type to another
- `src/common_cpp/Converter/DataConverters` provides implementations of the data conversions
- `src/common_cpp/Converter/ConverterFactory` provides a function like `TYPE2* convert<TYPE1, TYPE2>(TYPE1* data)` with implementations for each of the types. This then provides explicit conversion (i.e. where both input and output types are known).
- `src/common_cpp/Utils/PyObjectWrapper` provides functions for wrapping all of the data types into a `PyObject*`. It also provides a function that unwraps the `PyObject*`, figures out the data type and returns a data of the appropriate type.
- `src/common_cpp/API/PyWrapMapBase` calls `unwrap` based on the type stored in the `PyObject*`.

Chapter 4

Running the Monte Carlo

The simulation module provides particle generation routines, GEANT4 bindings to track particles through the geometry and routines to convert modelled energy loss in detectors into digitised signals from the MICE DAQ. The Digitisation models are documented under each detector. Here we describe the beam generation and GEANT4 interface.

4.1 Beam Generation

Beam generation is handled by the MapPyBeamMaker module. Beam generation is separated into two classes. The MapPyBeamGenerator has routines to assign particles to a number of individual beam classes, each of which samples particle data from a predefined parent distribution. Beam generation is handled by the `beam` datacard.

The MapPyBeamMaker can either take particles from an external file, overwrite existing particles in the spill, add a specified number of particles from each beam definition, or sample particles from a binomial distribution. The random seed is controlled at the top level and different algorithms can be selected influencing how this is used to generate random seeds on each particle.

Each beam definition has routines for sampling from a multivariate gaussian distribution or generating ensembles of identical particles (called "pencil" beams here). Additionally it is possible to produce time distributions that are either rectangular or triangular in time to give a simplistic representation of the MICE time distribution.

The beam definition controls are split into four parts. The `reference` branch defines the centroid of the distribution; the `transverse` branch defines the transverse coordinates, x, y, px, py ; the `longitudinal` branch defines the longitudinal coordinates - time and energy/momentum and the `coupling` branch defines correlations between longitudinal and transverse. Additionally a couple of parameters are available to control random seed generation and relative weighting between different beam definitions.

In transverse, beams are typically sampled from a multivariate gaussian.

The Twiss beam ellipse is defined by

$$\mathbf{B}_\perp = m \begin{pmatrix} \epsilon_x \beta_x / p & -\epsilon_x \alpha_x & 0 & 0 \\ -\epsilon_x \alpha_x & \epsilon_x \gamma_x p & 0 & 0 \\ 0 & 0 & \epsilon_y \beta_y / p & -\epsilon_y \alpha_y \\ 0 & 0 & -\epsilon_y \alpha_y & \epsilon_y \gamma_y p \end{pmatrix} \quad (4.1)$$

The Penn beam ellipse is defined by,

$$\mathbf{B}_\perp = m \epsilon_\perp \begin{pmatrix} \beta_\perp / p & -\alpha_\perp & 0 & -\mathcal{L} + \beta_\perp B_0 / 2p \\ -\alpha_\perp & \gamma_\perp p & \mathcal{L} - \beta_\perp B_0 / 2p & 0 \\ 0 & \mathcal{L} - \beta_\perp B_0 / 2p & \beta_\perp / p & -\alpha_\perp \\ -\mathcal{L} + \beta_\perp B_0 / 2p & 0 & -\alpha_\perp & \gamma_\perp p \end{pmatrix} \quad (4.2)$$

where parameters can be controlled in datacards as described below. Note that using the datacards it is possible to define a beam ellipse that is poorly conditioned (determinant nearly zero). In this case MAUS will print an error message like **Warning: invalid value encountered in double_scalars** for each primary.

4.1.1 Beam Polarisation

It is also possible to pass a polarised beam through MAUS. A polarised beam can be generated using the `beam_polarisation` variable on an individual beam parameter. Currently only one polarisation model has been implemented, `gaussian_unit_vectors`. This throws a Gaussian in each of the x, y and z directions and uses this to generate a spin vector. The spin vector is then normalised to 1. Correlations are not implemented.

4.1.2 Amplitude Momentum Correlation

It is possible to introduce artificially a correlation between transverse amplitude (action) and momentum. This can be of use for high emittance beams, such as those in MICE, where the time of flight of high amplitude particles is significantly different to the time of flight of low amplitude particles. The optional `a-p_correlation` dict enables one to specify a correlation C (see table 4.8). In this case, the `momentum_variable` W_o is modified according to

$$W_o = W_i(1 + CA). \quad (4.3)$$

W_i is the `momentum_variable` as calculated by the longitudinal routines above, C is the correlation magnitude and amplitude A is calculated using

$$A = |\mathbf{V}|^{1/4} m^2 (u^T \mathbf{V}^{-1} \vec{u}) \quad (4.4)$$

where \vec{u} is the particle phase space vector, m is the particle mass and \mathbf{V} is the ideal beam matrix defined by the `transverse` dict.

4.2 Getting the Right Answer

In MICE, the code is required to get the right answer for a number of difference use cases. MICE needs accurate stepping through the complex field maps,

Table 4.1: Control parameters pertaining to all beam definitions.

| Name | Meaning |
|--|---|
| <code>beam</code> | dict containing beam definition parameters. |
| <i>The following cards should all be defined within the beam dict.</i> | |
| <code>particle_generator</code> | Set to <code>binomial</code> to choose the number of particles by sampling from a binomial distribution. Set to <code>counter</code> to choose the number of particles in each beam definition explicitly. Set to <code>file</code> to generate particles by reading an input file. Set to <code>overwrite_existing</code> to generate particles by overwriting existing primaries. |
| <code>binomial_n</code> | When using a binomial <code>particle_generator</code> , this controls the number of trials to make. Otherwise ignored. |
| <code>binomial_p</code> | When using a binomial <code>particle_generator</code> , this controls the probability a trial yields a particle. Otherwise ignored. |
| <code>beam_file_format</code> | When using a file <code>particle_generator</code> , set the input file format - options are <ul style="list-style-type: none"> • <code>icool_for009</code> • <code>icool_for003</code>, • <code>g4beamline_bl_track_file</code> • <code>g4mice_special_hit</code> • <code>g4mice_virtual_hit</code> • <code>mars_1</code> • <code>maus_virtual_hit</code> • <code>maus_primary</code> |
| <code>beam_file</code> | When using a file <code>particle_generator</code> , set the input file name. Environment variables are automatically expanded by MAUS. |
| <code>file_particles_per_spill</code> | When using a file <code>particle_generator</code> , this controls the number of particles per spill that will be read from the file. |
| <code>random_seed</code> | Set the random seed, which is used to generate individual random seeds for each primary (see below). |
| <code>definitions</code> | A list of dicts, each item of which is a dict defining the distribution from which to sample individual particles. |

Table 4.2: Individual beam distribution parameters.

| Name | Meaning |
|---|---|
| <i>The following cards should be inside a dict in the beam definitions list.</i> | |
| <code>random_seed_algorithm</code> | Choose from the following options <ul style="list-style-type: none"> • <code>beam_seed</code>: use the <code>random_seed</code> for all particles • <code>random</code>: use a different randomly determined seed for each particle • <code>incrementing</code>: use the <code>random_seed</code> but increment by one each time a new particle is generated • <code>incrementing_random</code>: determine a seed at random before any particles are generated; increment this by one each time a new particle is generated |
| <code>weight</code> | When <code>particle_generator</code> is <code>binomial</code> or <code>overwrite_existing</code> , the probability that a particle will be sampled from this distribution is given by $weight/(sumofweights)$. |
| <code>n_particles_per_spill</code> | When <code>particle_generator</code> is <code>counter</code> , this sets the number of particles that will be generated in each spill. |
| <code>reference</code> | Dict containing the reference particle definition. |
| <code>transverse</code> | Dict defining the longitudinal phase space distribution. |
| <code>longitudinal</code> | Dict defining the longitudinal phase space distribution. |
| <code>coupling</code> | Dict defining any correlations between transverse and longitudinal. |
| <code>beam_polarisation</code> | Optional dict defining the polarisation of the beam. If this dict is not included, the beam is taken to be unpolarised. |
| <code>a-p_correlation</code> | Optional dict that defines a correlation between transverse amplitude and longitudinal momentum. If this dict is not included, no such correlation is introduced. |

Table 4.3: Beam distribution reference definition.

| Name | Meaning |
|---|---|
| <i>The following cards should be defined in each beam definition reference dict.</i> | |
| <code>position</code> | dict with elements <code>x</code> , <code>y</code> and <code>z</code> that define the reference position (mm). |
| <code>momentum</code> | dict with elements <code>x</code> , <code>y</code> and <code>z</code> that define the reference momentum direction. Normalised to 1 at runtime. |
| <code>particle_id</code> | PDG particle ID of the reference particle. |
| <code>energy</code> | Reference energy. |
| <code>time</code> | Reference time (ns). |
| <code>random_seed</code> | Set to 0 - this parameter is ignored. |

Table 4.4: Beam definition transverse parameters.

| Name | Meaning |
|--|---|
| <i>The following cards should be defined in each beam definition transverse dict.</i> | |
| <code>transverse_mode</code> | Options are <ul style="list-style-type: none"> • <code>pencil</code>: <code>x</code>, <code>py</code>, <code>y</code>, <code>py</code> taken from <code>reference</code> • <code>penn</code>: cylindrical beam symmetric in <code>x</code> and <code>y</code> • <code>constant_solenoid</code>: cylindrical beam symmetric in <code>x</code> and <code>y</code>, with beam radius calculated from on-axis B-field to give constant beam radius along a solenoid. • <code>twiss</code>: beam with decoupled <code>x</code> and <code>y</code> beam ellipses. |
| <code>normalised_angular_momentum</code> | if <code>transverse_mode</code> is <code>penn</code> or <code>constant_solenoid</code> , set \mathcal{L} . |
| <code>emittance_4d</code> | if <code>transverse_mode</code> is <code>penn</code> or <code>constant_solenoid</code> , set ϵ_{\perp} . |
| <code>beta_4d</code> | if <code>transverse_mode</code> is <code>penn</code> , set β_{\perp} . |
| <code>alpha_4d</code> | if <code>transverse_mode</code> is <code>penn</code> , set α_{\perp} . |
| <code>bz</code> | if <code>transverse_mode</code> is <code>constant_solenoid</code> , set the B-field used to calculate β_{\perp} and α_{\perp} . |
| <code>beta_x</code> | if <code>transverse_mode</code> is <code>twiss</code> , set β_x . |
| <code>alpha_x</code> | if <code>transverse_mode</code> is <code>twiss</code> , set α_x . |
| <code>emittance_x</code> | if <code>transverse_mode</code> is <code>twiss</code> , set ϵ_x . |
| <code>beta_y</code> | if <code>transverse_mode</code> is <code>twiss</code> , set β_y . |
| <code>alpha_y</code> | if <code>transverse_mode</code> is <code>twiss</code> , set α_y . |
| <code>emittance_y</code> | if <code>transverse_mode</code> is <code>twiss</code> , set ϵ_y . |

Table 4.5: Beam definition longitudinal parameters.

| Name | Meaning |
|---|---|
| <i>The following cards should be defined in each beam definition longitudinal dict.</i> | |
| momentum_variable | In all modes, set this variable to control which longitudinal variable will be used to control the input beam. Options are energy , p , pz . |
| longitudinal_mode | Options are <ul style="list-style-type: none"> • pencil: time, energy/p/pz taken from reference • gaussian: uncorrelated gaussians in time and energy/p/pz • twiss: multivariate gaussian in time and energy/p/pz • uniform_time: gaussian in energy/p/pz and uniform in time. • sawtooth_time: gaussian in energy/p/pz and sawtooth in time. |
| beta_l | In Twiss mode, set β_l |
| alpha_l | In Twiss mode, set α_l |
| emittance_l | In Twiss mode, set ϵ_l |
| sigma_t | In gaussian mode, set the RMS time. |
| sigma_p | |
| sigma_energy | In gaussian , uniform_time , sawtooth_time mode, set the RMS energy/p/pz. |
| sigma_pz | |
| cov(t,p) | |
| cov(t,energy) | In gaussian mode, set the covariance between p/energy/pz and time and energy. It is an error if this results in a matrix that is not positive definite (eigenvalues positive). |
| cov(t,pz) | |
| t_start | In uniform_time and sawtooth_time mode, set the start time of the parent distribution |
| t_end | In uniform_time and sawtooth_time mode, set the end time of the parent distribution |

Table 4.6: Beam definition coupling parameters.

| Name | Meaning |
|---|---|
| <i>The following cards should be defined in each beam definition coupling dict.</i> | |
| coupling_mode | Set to none - not implemented yet. |

Table 4.7: Beam definition polarisation.

| Name | Meaning |
|---|---|
| <i>The following cards should be defined in each beam definition <code>beam_polarisation</code> dict.</i> | |
| <code>polarisation_mode</code> | If set to <code>flat</code> , the beam is taken as unpolarised. If set to <code>gaussian_unit_vectors</code> , spin vector is given by a gaussian distribution in x, y, z; the spin vector is then normalised to 1 before tracking. |
| <code>beam_mean_x</code> | If <code>beam_polarisation</code> is set to <code>gaussian_unit_vectors</code> , the mean x value of the gaussian. |
| <code>beam_sigma_x</code> | If <code>beam_polarisation</code> is set to <code>gaussian_unit_vectors</code> , the sigma x value of the gaussian. |
| <code>beam_mean_y</code> | If <code>beam_polarisation</code> is set to <code>gaussian_unit_vectors</code> , the mean y value of the gaussian. |
| <code>beam_sigma_y</code> | If <code>beam_polarisation</code> is set to <code>gaussian_unit_vectors</code> , the sigma y value of the gaussian. |
| <code>beam_mean_z</code> | If <code>beam_polarisation</code> is set to <code>gaussian_unit_vectors</code> , the mean z value of the gaussian. |
| <code>beam_sigma_z</code> | If <code>beam_polarisation</code> is set to <code>gaussian_unit_vectors</code> , the sigma z value of the gaussian. |

Table 4.8: Beam definition amplitude-momentum correlation.

| Name | Meaning |
|---|---|
| <i>The following cards should be defined in each beam definition <code>a-p_correlation</code> dict.</i> | |
| <code>magnitude</code> | The magnitude of the amplitude-momentum correlation. |
| <code>momentum_variable</code> | Optional parameter to specify the momentum variable W. Options are <code>energy</code> , <code>p</code> , <code>pz</code> . If not specified, defaults to <code>momentum_variable</code> from <code>longitudinal</code> dict. |

correct energy loss and scattering in the emittance absorbers and diffuser and accurate energy deposition in the sensitive detectors and correct showering especially in the downstream detectors. The *Right Answer* in this case is the one that agrees with experiment.

4.2.1 Geometry

There are copious comments on setting up your own geometry in the relevant chapter. I only remark here that you should

- Visualise the geometry.
- Set `verbose_level` to 1 so that MAUS reports the field configuration in it's output file.
- Check the field maps using e.g. `bin/examples/make_field_map.py`.
- Set `check_volume_overlaps` to `True` to call Geant4 internal checks for geometry consistency.

Otherwise it is highly unlikely that you will get the correct geometry.

4.2.2 Tracking

The principle tool that can be used to ensure a correct answer from tracking through the field maps is the step size. This is controlled either from Mice-Modules by setting the `G4StepMax` parameter per volume; or from data cards by setting the `max_step_length` parameter. Setting this parameter to a small value increases the tracking time; setting it to a large value decreases the accuracy. Numerically, 100 mm is found to be a reasonable value for sufficiently accurate stepping through the fields [citation: C Rogers thesis]. No one has ever studied effect of miss distance on e.g. some of the MICE apertures.

It is also wise to avoid hard field edge boundaries in the cooling channel. MAUS uses by default 4th order Runge Kutta for numerical integration (`RK4`, `stepping_algorithm = "ClassicalRK4"`). For each tracking step, `RK4` calls the MAUS field map routines 4 times. Geant4/`RK4` only knows about the field value at these four points, and makes some smoothing approximation at intermediate points. If the geometry presents a field inhomogeneity i.e. a hard edged boundary, it will severely degrade the stability of the tracking. The way to fix this is to implement Geant4 volume boundaries on either side of the edge of any field maps. This forces Geant4 to stop tracking, step over the field boundary, and then start tracking again.

4.2.3 Energy Deposition and Showering

There are a couple of other considerations for handling energy deposition, decays and so forth. `physics_model` is the master control variable, which tells Geant4 which physics model to use. The Geant4 mindset is that Geant4 provides a library of physics processes, and that the defaults are not necessarily correct for all use cases. This is different to e.g. `MARS` or equivalent tools. Rogers has selected `QGSP_BERT` as a reasonable default, following recommendation from G4Beamline developers.

The MICE beam is quite highly polarised. Polarised decay is possible to do in MAUS (`polarised_decay` and `spin_tracking`), but it is poorly understood experimentally so it is not active by default. Be aware that probably electron background estimation is wrong in MICE/MAUS.

If the physics you wish to study includes showering effects, check that you are happy with the `kinetic_energy_threshold`, `production_threshold` and `fine_grained_production_threshold` parameters. The `kinetic_energy_threshold` sets the minimum energy of particles that will be tracked and the `production_threshold` parameters control the minimum range of particles that will be produced.

The `fine_grained_production_threshold` sets the geant4 production threshold per particle and per region. Regions are defined using the `MiceModule Region` string property, which can map several volumes to the same region. `fine_grained_production_threshold` should be a dictionary that maps the string name of a region to another dictionary. This dictionary should map the string name or pdg encoded integer id in string format to the production threshold. For example, the entry in the datacards file might look like

```
fine_grained_production_threshold = {
    "my_region":{
        "e+":0.1,
        "11":0.01,
        "22":-1
    }
}
```

which would set production thresholds for all `MiceModules` in `my_region` to 0.1 mm for positrons, 0.01 mm for electrons, and use the Geant4 defaults for gammas. All other particles would take their production threshold defaults from `production_threshold` datacard.

4.3 GEANT4 Bindings

The GEANT4 bindings are encoded in the Simulation module. GEANT4 groups particles by run, event and track. A GEANT4 run maps to a MICE spill; a GEANT4 event maps to a single inbound particle from the beamline; and a GEANT4 track corresponds to a single particle in the experiment.

A number of classes are provided for basic initialisation of GEANT4.

- `MAUSGeant4Manager`: is responsible for handling interface to GEANT4. `MAUSGeant4Manager` handles initialisation of the GEANT4 bindings as well as accessors for individual GEANT4 objects (see below). Interfaces are provided to run one or many particles through the geometry, returning the relevant event data. The `MAUSGeant4Manager` sets and clears the event action before each run.
- `MAUSPhysicsList`: contains routines to set up the GEANT4 physical processes. Datacards settings are provided to disable stochastic processes or all processes and set a few parameters. In the end, the physics list set up gets called by the `FieldPhaser`.

- **FieldPhaser:** the field phaser is a MAUS-specific tool for automatically phasing fields, for example RF cavities, such that they ramp coincidentally with incoming particles. The FieldPhaser contains routines to fire test ("reference") particles through the accelerator lattice and phase fields appropriately. The FieldPhaser phasing routines are called after GEANT4 is first initialised.
- **DetectorConstruction:** the DetectorConstruction routines provide an interface between the MAUS internal geometry representation encoded in MiceModules and GEANT4. DetectorConstruction is responsible for calling the relevant routines for setting up the general engineering geometry, calling detector-specific geometry set-up routines and calling the field map set-up routines.
- **VirtualPlanes:** the VirtualPlanes routines are designed to extract particle data from the GEANT4 tracking independently of the GEANT4 geometry. The VirtualPlanes routines watches for steps that step across some plane in physical space, or some time, or some proper time, and then interpolates from the step ends to the plane in question.
- **FillMaterials:** (legacy) the FillMaterials routines are used to initialise a number of specific
- **MAUSVisManager** the MAUSVisManager is responsible for handling interfaces with the GEANT4 visualisation.

The GEANT4 *Action* objects provide interfaces for MAUS-specific function calls at certain points in the tracking.

- **MAUSRunAction:** sets up the running for a particular spill. In MAUS, it just reinitialises the visualisation.
- **MAUSEventAction:** sets up the running for a particular inbound particle. At the beginning of each event, the virtual planes, tracking, detectors and stepping are all cleared. After the event the event data is pulled into the event data from each element.
- **MAUSTrackingAction:** is called when a new track is created or destroyed. If `keep_tracks` datacard is set to True, on particle creation, MAUSTrackingAction writes the initial and final track position and momentum to the output data tree. If `keep_steps` is set to True MAUSTrackingAction gets step data from MAUSSteppingAction and writes this also.
- **MAUSSteppingAction:** is called at each step of the particle. If `keep_steps` datacard is set to True, output step data is recorded. MAUSSteppingAction kills particles if they exceed the `maximum_number_of_steps` datacard. MAUSSteppingAction calls the VirtualPlanes routines on each step.
- **MAUSStackingAction:** is called when a new track is created, prioritising particle tracking. Handles killing particles based on the `kinetic_energy_threshold`, `default_keep_or_kill` and `keep_or_kill_particles` datacards.

Table 4.9: Monte Carlo control parameters.

| Name | Meaning |
|--|---|
| <i>General Monte Carlo controls.</i> | |
| <code>simulation_geometry_filename</code> | Filename for the simulation geometry - searches first in files tagged by environment variable <code>\${MICEFILES}</code> , then in the local directory. |
| <code>simulation_reference_particle</code> | Reference particle used for phasing fields. The format is as defined for a <code>reference</code> entry in a beam. |
| <code>keep_tracks</code> | Set to boolean true to store the initial and final position/momentum of each track generated by MAUS. |
| <code>keep_steps</code> | Set to boolean true to store every step generated by MAUS - warning this can lead to large output files. |
| <code>check_volume_overlaps</code> | Set to a boolean value. Check for overlaps in volumes. If an overlap is detected, Geant4 will report a warning and then quit. |
| <code>everything_special_virtual</code> | Set to a boolean value. If true, all volumes will be made special virtual and record e.g. energy deposited. |

- `MAUSPrimaryGeneratorAction`: is called at the start of every event and sets the particle data for each event. In MAUS, this particle generation is handled externally and so the `MAUSPrimaryGeneratorAction` role is to look for the primary object on the Monte Carlo event and convert this into a GEANT4 event object.

Table 4.10: Tracking control parameters.

| <i>Tracking control parameters.</i> | |
|---|--|
| <code>max_step_length</code> | Default maximum step size during tracking. Override with <code>G4StepMax</code> in <code>MiceModule</code> . |
| <code>max_track_time</code> | Kill tracks with time above this time. Override with <code>G4TimeMax</code> in <code>MiceModule</code> . |
| <code>max_track_length</code> | Kill tracks with track length above this length. Override with <code>G4TrackMax</code> in <code>MiceModule</code> . |
| <code>maximum_number_of_steps</code> | Set to an integer value. Tracks taking more steps are assumed to be looping and are killed. |
| <code>kinetic_energy_threshold</code> | Kill tracks with initial kinetic energy below this threshold. Override with <code>G4KinMin</code> in <code>MiceModule</code> . |
| <code>field_tracker_absolute_error</code> | Set absolute error on MAUS internal stepping routines - used by e.g. <code>VirtualPlanes</code> to control accuracy of interpolation. |
| <code>field_tracker_relative_error</code> | Set relative error on MAUS internal stepping routines - used by e.g. <code>VirtualPlanes</code> to control accuracy of interpolation. |
| <code>stepping_algorithm</code> | String to control the numerical integration routine - choose from <code>ClassicalRK4</code> , <code>SimpleHeum</code> , <code>ImplicitEuler</code> , <code>SimpleRunge</code> , <code>ExplicitEuler</code> or <code>CashKarpRKF45</code> . |
| <code>spin_tracking</code> | Set to true to use G4 routines to process the spin vector as particles go through EM fields. |
| <code>delta_one_step</code> | Accuracy with which Geant4 steps within a volume. |
| <code>epsilon_min</code> | Geant4 minimum stepping relative error over a single step. Takes precedence over <code>delta_one_step</code> . |
| <code>epsilon_max</code> | Geant4 maximum stepping relative error over a single step. Takes precedence over <code>delta_one_step</code> . |
| <code>delta_intersection</code> | Accuracy with which Geant4 enters volume boundaries. |
| <code>miss_distance</code> | Maximum distance between track and corners, used for estimating whether a track crosses a boundary. |

Table 4.11: Physics list control parameters.

| <i>Physics list controls.</i> | |
|--|--|
| <code>physics_model</code> | GEANT4 physics model used to set up the physics list. |
| <code>physics_processes</code> | Choose which physics processes normal particles observe during tracking. Options are <ul style="list-style-type: none"> • <code>normal</code> particles will obey normal physics processes, scattering and energy straggling will be active. • <code>mean_energy_loss</code> particles will lose a deterministic amount of energy during interaction with materials and will never decay. • <code>none</code> Particles will never lose energy or scatter during tracking and will never decay. |
| <code>reference_physics_processes</code> | Choose which physics processes the reference particle observes during tracking. Options are <code>mean_energy_loss</code> and <code>none</code> . The reference particle can never have stochastic processes enabled. |
| <code>particle_decay</code> | Set to boolean true to enable particle decay; set to boolean false to disable. |
| <code>polarised_decay</code> | Set to boolean true to make muons decay according to standard physics for a polarised muon; set to boolean false to make muons decay as if unpolarised. If polarised decay is true, then spin tracking is automatically enabled, regardless of the value of the <code>spin_tracking</code> datacard. |
| <code>charged_pion_half_life</code> | Set the half life for charged pions. |
| <code>muon_half_life</code> | Set the half life for muons. |
| <code>production_threshold</code> | Set the geant4 production threshold. Uses geant4 defaults if negative. Ignored if <code>physics_processes</code> are not <code>normal</code> . |
| <code>fine_grained_production_threshold</code> | Set the geant4 production threshold per particle and per region. See text. |
| <code>kinetic_energy_threshold</code> | 34 Threshold for kinetic energy of new particles at production. Particles with kinetic energy below this value will not be tracked. |
| <code>default_keep_or_kill</code> | If set to <code>true</code> , keep particles with type not listed in <code>keep_or_kill_particles</code> . If set to <code>false</code> , kill parti- |

Table 4.12: Visualisation control parameters.

| <i>Visualisation controls.</i> | |
|-----------------------------------|--|
| <code>geant4_visualisation</code> | Set to boolean true to activate GEANT4 visualisation. |
| <code>visualisation_viewer</code> | Control which viewer to use to visualise GEANT4 tracks. Currently only <code>vrmlviewer</code> is compiled into GEANT4 by default. Users can recompile GEANT4 with additional viewers enabled at their own risk. |
| <code>visualisation_theta</code> | Set the theta angle of the camera. |
| <code>visualisation_phi</code> | Set the phi angle of the camera. |
| <code>visualisation_zoom</code> | Set the camera zoom. |
| <code>accumulate_tracks</code> | Set to 1 to accumulate all of the simulated tracks into one vrml file. 0 for multiple files. |
| <code>default_vis_colour</code> | Set the RGB values to alter the default colour of particles. |
| <code>pi_plus_vis_colour</code> | Set the RGB values to alter the colour of positive pions. |
| <code>pi_minus_vis_colour</code> | Set the RGB values to alter the colour of negative pions. |
| <code>mu_plus_vis_colour</code> | Set the RGB values to alter the colour of positive muons. |
| <code>mu_minus_vis_colour</code> | Set the RGB values to alter the colour of negative muons. |
| <code>e_plus_vis_colour</code> | Set the RGB values to alter the colour of positrons. |
| <code>e_minus_vis_colour</code> | Set the RGB values to alter the colour of electrons. |
| <code>gamma_vis_colour</code> | Set the RGB values to alter the colour of gammas. |
| <code>neutron_vis_colour</code> | Set the RGB values to alter the colour of neutrons. |
| <code>photon_vis_colour</code> | Set the RGB values to alter the colour of photons. |

Chapter 5

Geometry

MAUS uses the on-line Configuration Database to store all of its geometries. These geometries have been transferred from CAD drawings which are based on the latest surveys and technical drawings available. The CAD drawings are translated to a geometry specific subset of XML, the Geometry Description Markup Language (GDML) prior to being recorded in the configuration database. Translation of the CAD drawings is accomplished through the use of a commercial software package known as Fast-RAD. In principle this may be done using a combination of the open source software packages FreeCAD and CADMesh to translate the CAD drawings into a GEANT4 readable format, but such an avenue has not yet been fully explored.

The CAD drawings contain the beam-line elements and the positions of the detector survey points. These objects are described in the GDML files using Tessellated solids to define the shapes of the physical volumes. The detectors themselves are described using an independently generated set of GDML files using GEANT4 standard volumes. An additional XML file is appended to the geometry description that assigns magnetic fields and associates the detectors to their locations in the GDML files generated by Fast-RAD. This file is initially written by the geometry maintainers and formatted to contain run specific information during download.

The GDML format has a number of benefits. the files can be read via a number of already existing libraries in GEANT4 and ROOT for the purpose of independent verification and validation. For example the GEANT4 example “extended/persistancy/gdml/G01” was used extensively for validating the GDML files produced by Fast-RAD. Because it is a subset of XML, the data contained in the GDML files are readily accessible through the application of the “libxml2” python extension. The GDML are in turn translated into the MAUS readable geometry files either by directly accessing the data using the python extension (which is the method applied to the detector objects) or through the use of EXtensible Stylesheet Language Transformations (XSLT) which applies a set of predefined transformations to the XML files.

The following section shall describe how to use the available executable to access and use these models.

5.1 Geometry Download

There are three executable files available to users which reside in the directory `/bin/utilities` found within your copy of MAUS. The three files of interest are `upload_geometry.py`, `download_fit_geometry.py` and `get_geometry_ids.py`. These files do the following.

Upload Geometry

1. Set up the `Configreader` class and read the values provided by `ConfigurationDefaults.py` or by custom configure files.
2. Instantiate an `Uploader` class object using the upload directory and geometry note taken from the configuration file.
3. The list of files which is created by the `Uploader` class is used to compress the geometry files into one zip file.
4. This zip file is then used as the argument for the `upload_to_CDB` method which takes the contents of the zip and then uploads this, as a single string to the CDB.

Optional If cleanup is specified in the configuration file then the file list and the original GDML files are the deleted leaving only the zip file.

Download Geometry

1. Set up the `Configreader()` class and read the values provided by `ConfigurationDefaults.py` or by custom configuration files.
2. Instantiate a `Downloader` class object and downloads either the current, time specified or run number zipped geometry to a temporary cache location.
3. The zip file is then unzipped in this location.
4. The `Location Fit` is called which extracts the expected positions of the detector elements, the measured position of the survey points, and the anticipated positions of the survey points with respect to the detector center from the GDML files. The fit completes a fit with a chi-square statistic to match the position of the survey nest in the detector coordinate system to its position in the hall coordinate system using a change in the position and the rotation of the detector. The result is written to the GDML file. If the detector description is present in the download from CDB, that detector file name is also written to the main GDML file in place of the place-holder element.
5. The `Formatter` class is called which formats the GDML files. The formatting alters the schema location of these files and points them to the correct local locations of the Materials GDML file. This formatting leaves the original GDMLs in the temporary cache and places the new formatted files in the download directory specified by the configuration file.
6. `GDMLtoMAUS` is then called with the location of the new formatted files as its argument. This class converts the CAD GDMLs to the MICE Module text files using the XSLT stylesheets previously described and the Detector GDMLs to MICE modules using a python driven routine.

Optional If specified in the configuration file the temporary cache location is removed along with the zip file and unzipped files.

- Get Geometry IDs**
1. Set up the `Configreader()` class and read the values provided by `ConfigurationDefaults.py` or by custom configuration files. This file takes start and stop time arguments to specify a period to search the CDB.
 2. A CDB class object is then instantiated with the server specified in the configuration file.
 3. The `get_ids` method from the CDB class is called and the python dict which is downloaded is formatted and either printed to screen or to file as specified in the configuration file.

Two other python files are also present in the utilities directory; `process_geometry.py` which fits, formats, and processes the GDML files assuming the download is complete, and `download_geometry.py` which downloads, formats, and processes the GDML files without applying the location fit— legacy MICE module files will be used in the simulation rather than the downloaded detector geometry files because the Location fit makes this replacement. To use these files the user must use the arguments in the “`ConfigurationDefaults.py`” file. The arguments relating to these executables are as follows.

5.2 Using the Geometry Download Executables

The three executables described above will allow the user to accomplish three different tasks; adding a new geometry to the database, checking what geometries are available, and downloading the desired geometry. The majority of users will not need to upload a new geometry. At present this can only be done from the MLCR. The second two operations are of primary interest for the everyday user. A list of the CAD based geometries appears at <http://cdb.mice.rl.ac.uk/cdbviewer/>, and selecting the geometry tab. The user should be advised, however, that this list does not contain all of the information necessary to run the geometry download procedure. The best procedure is to use the `get_geometry_ids.py` executable described above. For example to get all available entries in the geometry database a user should run the command (from the maus root directory)

```
> python /bin/utilities/get_geometry_ids.py
   --get_ids_start_time '1974-01-01 00:00:00' --get_ids_stop_time '2015-01-01 00:00:00'
```

By default, the output file is saved to `$MAUS_ROOT_DIR/tmp/geometry_ids.txt`. The typical output looks like the following:

[...]

```
Geometry Number = 22
Geometry Note = Step IV geometry consisting of the detectors only for
debugging purposes. Includes the TOFs, Ckov, EMR, Tracker, and KL as
GDML files. EMR gdml file present, but not in use. Beamline elements
not included, but fields are present for quads, dipole, and
```

Table 5.1: Geometry control parameters.

| <i>Geometry controls.</i> | |
|---|--|
| <code>cdb_upload_url</code> | Sets the upload url relating the the Configuration Database. |
| <code>cdb_download_url</code> | Sets the download url relating the the Configuration Database. |
| <code>geometry_download_wsdl</code> | Name of the web service used for downloads. |
| <code>geometry_download_directory</code> | Set the directory where you wish the geometry to be downloaded to. |
| <code>geometry_download_by</code> | This can be set to either <i>current</i> , <i>id</i> or <i>run_number</i> . Current will download the current valid geometry stored on the CDB. ID will download the geometry for the ID specified N.B ID numbers can be found using the <code>get geometry ids</code> executable. Run_number will download the geometry along with control room information for specified run including the beam-line currents. |
| <code>geometry_download_run_number</code> | Set the number of the run to be downloaded. |
| <code>geometry_download_id</code> | Set the number of the geometry ID to be downloaded. |
| <code>geometry_download_cleanup</code> | Set to True in order to cleanup the temporary files created during the download process. These are the zip file downloaded and the original GDML files from this zip file. |
| <code>g4_step_max</code> | Set the G4 step max number which will be set in the ParentGeometryFile. This relates to the size of steps carried out during the simulation. |
| <code>geometry_upload_wsdl</code> | Name of the web service used for uploads. For developers use only. |
| <code>geometry_upload_directory</code> | Set the the directory which stores the Fast-RAD produced GDML files which will be stored on the CDB. For Developers use only. |
| <code>geometry_upload_note</code> | Write the description of the geometry which is going to be uploaded. This should describe what is in the beam line specifically what is new to the model. It should also include any other information the developer wishes the user to know. For developers use only. |
| <code>geometry_upload_valid_from</code> | Set the date-time format of the date when this geometry about to be uploaded is valid from. For developers use only. |
| <code>geometry_upload_cleanup</code> | Set to True in order to cleanup the temporary files created during the upload process. These are the file containing the list of GDMLs to be uploaded and also the original GDML files. For developers use only. |
| <code>get_ids_start_time</code> | Set the start time of the period which you would like to get the ids from the configuration database. Must be in |

solenoid. Ckov files recreate MICE modules to generate incorrect conical mirror object. A 180 degree rotation is applied to Tracker0 with respect to Tracker1. Survey information not included. Default tracker Solenoid magnetic fields implemented with scaling to match legacy files.

ValidFrom = 1974-02-04 19:00:00
Date Created = 2014-04-30 14:23:18.880000

Geometry Number = 23

Geometry Note = Step IV geometry with detectors including the TOFs, Ckov, EMR, Tracker, and KL included as GDML files. EMR gdml file present, but not in use. Downstream solenoid bore gdml file has been edited to remove an apparent piece of material blocking the beam. Ckov files recreate MICE modules to generate incorrect conical mirror object. A 180 degree rotation is applied to Tracker0 with respect to Tracker1. Survey information not included. Default tracker Solenoid magnetic fields implemented with scaling as in legacy files. Removed redundant objects from geometry description.

ValidFrom = 1974-02-04 18:00:00
Date Created = 2014-04-30 14:44:10.774000

Geometry Number = 24

Geometry Note = Step I geometry with detectors including the TOFs, Ckov, EMR, Tracker, and KL included as GDML files. EMR gdml file present, but not in use. Ckov files recreate MICE modules to generate incorrect conical mirror object. Survey information included.

ValidFrom = 1974-02-03 18:00:00
Date Created = 2014-04-30 16:05:43.553000

Three different flavors of geometry are represented here. The first example is a geometry with no beamline elements included but with all Step IV detectors and fields in place. This type of geometry has been made available to test changes in the software while avoiding the processing time necessary to load the tessellated solids used to describe the beamline. The second is an idealized version of the Step IV geometry based entirely on the CAD geometry. The idealized geometries are labeled with a year of 197n for the “Date Valid From” where n is the step number. The third example is a real version of the Step I geometry with the survey information included for all detectors.

The CAD-based geometry can be downloaded via a number of different modes. The simplest way is to download the geometry by its id number. From the MAUS root directory the debug geometry as described above can be downloaded with the command

```
> python bin/utilities/download_fit_geometry.py --geometry_download_id 22
```

By default the GDML files will be removed with this command. If the user wishes to download the full geometry without removing the GDML files because that user wants to run a systematic study requiring reprocessing the geometry then the following command should be used:

```
> python bin/utilities/download_fit_geometry.py --geometry_download_id 24 --geometry_download_cleanup F
```

A common usage for the geometry download is to reproduce a given run. To simulate a representative run from the 2013 EMR run the following command should be used:

```
> python bin/utilities/download_fit_geometry.py --geometry_download_by run_number --geometry_download_r
```

This function reads the beamline currents from the configuration database and adjusts the fields of the beamline magnets appropriately.

A final application is to download the latest uploaded geometry. This function can be completed using the following command:

```
> python bin/utilities/download_fit_geometry.py --geometry_download_by current
```

All of these commands described will by default place the geometry in the directory `$MAUS_ROOT_DIR/files/geometry/download`. This directory may be changed using the `--geometry_download_directory` flag. To use the downloaded geometry in the simulation, the `--simulation_geometry_filename` flag must be set to the download directory.

Chapter 6

How to Define a Geometry

Mice Modules are the objects that control the geometry and fields that are simulated in MAUS. They are used in conjunction with a datacard file, which provides global run control parameters. Mice Modules are created by reading in a series of text files when MAUS applications are run.

This geometry information is used primarily by the Simulation application for tracking of particles through magnetic fields. A few commands are specific to detector Reconstruction and accelerator beam Optics applications.

The Mice Modules are created in a tree structure. Each module is a parent of any number of child modules. Typically the parent module will describe a physical volume, and child modules will describe physical volumes that sit inside the parent module. Modules cannot be used to describe volumes that do not sit at least partially inside the volume of the parent module.

Each Mice Module file consists of a series of lines of text. Firstly the Module name is defined. This is followed by an opening curly bracket, then the description of the module and the placement of any child modules, and finally a closing curly bracket. Commands, curly brackets etc must be separated by an end of line character.

Comments are indicated using either two slashes or an exclamation mark. Characters placed after a comment on a line are ignored.

MAUS operates in a right handed coordinate system (x, y, z) . In the absence of any rotation, lengths are considered to be extent along the z -axis, widths to be extent along the x -axis and heights to be extent along the y -axis. Rotations $(\theta_x, \theta_y, \theta_z)$ are defined as a rotation about the z -axis through θ_z , followed by a rotation about the y -axis through θ_y , followed by a rotation about the x -axis through θ_x .

6.0.1 Configuration File

The Configuration file places the top level objects in MICE. The location of the file is controlled by the datacard `simulation_geometry_file_name`. MAUS looks for the configuration file in the first instance in the directory

```
${MICEFILES}/Models/Configuration/<MiceModel>
```

where `${MICEFILES}` is a user-defined environment variable. If MAUS fails to find the file it searches the local directory.

The world volume is defined in the Configuration file and any children of the world volume are referenced by the Configuration file. The Configuration file looks like

```
Configuration <Configuration Name>
```

```

{
  Dimensions <x> <y> <z> <Units>
  <Properties>
  <Child Modules>
}

```

<Configuration Name> is the name of the configuration. Typically the Configuration file name is given by <Configuration Name>.dat. The world volume is always a rectangular box centred on (0,0,0) with x , y , and z extent set by the Dimensions. Properties and Child Modules are described below and added as in any Module.

Substitutions

It is possible to make keyword substitutions that substitutes all instances of <name> with <value> in all Modules. The syntax is

```
Substitution <name> <value>
```

<name> must start with a single \$ sign. Substitutions must be defined in the Configuration file. Note this is a direct text substitution in the MiceModules before the modules are parsed properly. So for example,

```
Substitution $Sub SomeText
PropertyString FieldType {$Sub}
PropertyDouble {$SubValue 10}

```

would be parsed as MAUS like

```
PropertyString FieldType SomeText}
PropertyDouble SomeTextValue 10}

```

Expressions

The use of equations in properties of type double and Hep3Vector is also allowed in place of a single value. So, for example,

```
PropertyDouble FieldStrength 0.5*2 T
```

would result in a FieldStrength property of 1 Tesla.

Expression Substitutions

Some additional variables can be defined in specific cases by MAUS itself for substitution into expressions, in which case they will start with @ symbol. For these variable substitutions, it is only possible to make the substitution into expressions. So for example,

```
PropertyDouble ScaleFactor 2*@RepeatNumber
```

Would substitute @RepeatNumber into the expression. @RepeatNumber is defined by MAUS when repeating modules are used (see RepeatModule2, below). Note the following code is not valid

```
PropertyString FileName File@RepeatNumber //NOT VALID
```

This is because Expression Substitutions can only be used in an expression (i.e. an equation).

6.0.2 Module Files

Children of the top level Mice Module are defined by Modules. MAUS will attempt to find a module in an external file. The location of the file is controlled by the parent Module. Initially MAUS looks in the directory

```
 ${MICEFILES}/Models/Modules/<Module>
```

If the Mice Module cannot be found, MAUS searches the local directory. If the module file still cannot be found, MAUS will issue a warning and proceed.

The Module description is similar in structure to the Configuration file:

```
 Module <Module Name>
 {
   PropertyString Volume <Volume Type>
   PropertyHep3Vector Dimensions <Dimension1> <Dimension2> <Dimension3> <Units>
   <Properties>

   <Child Modules>
 }
```

<Module Name> is the name of the module. Typically the Module file name is given by <Module Name>.dat.

The definition of Volume, Dimensions, Properties and Child Modules are described below.

6.0.3 Volume and Dimensions

The volume described by the MiceModule can be one of several types. Replace <Volume Type> with the appropriate volume below. Cylinder, Box and Tube define cylindrical and cuboidal volumes. Polycone defines an arbitrary volume of rotation and is described in detail below. Wedge describes a wedge with a triangular projection in the y-z plane and rectangular projections in x-z and x-y planes. Quadrupole defines an aperture with four cylindrical pole tips.

In general, the physical volumes that scrape the beam are defined independently of the field maps. This is the more versatile way to do things, but there are some pitfalls which such an implementation introduces. For example, in hard-edged fields like pillboxes, tracking errors can be introduced when MAUS steps into the field region. This can be avoided by adding windows (probably made of vacuum material) to force GEANT4 to stop tracking, make a small step over the field boundary, and then restart tracking inside the field. However, such details are left for the user to implement.

| Volume | Dimension1 | Dimension2 | Dimension3 |
|------------|---|------------------|------------------------|
| None | No dimensions required. Note cannot define daughter Modules for this volume type. | | |
| Cylinder | Radius | Length in z | Not used (leave blank) |
| Box | Width in x | Height in y | Length along z |
| Tube | Inner Radius | Outer Radius | Length in z |
| Trapezoid | Half Width in x | Half Height in y | Half Length in z |
| Wedge | See documentation below. | | |
| Polycone | No dimensions required. Volume defined from external file. | | |
| Quadrupole | No dimensions required. Dimensions defined from module properties. | | |
| Multipole | No dimensions required. Dimensions defined from module properties. | | |
| Boolean | No dimensions required. Dimensions defined from module properties. | | |
| Sphere | See documentation below. | | |

| Volume | Dimension1 | Dimension2 | Dimension3 |
|--------|------------|------------|------------|
|--------|------------|------------|------------|

6.0.4 Properties

Many of the features of MAUS that can be enabled in a module are described using properties. For example, properties enable the user to define detectors and fields. Properties can be either of several types: PropertyDouble, PropertyString, PropertyBool, PropertyHep3Vector or PropertyInt. A property is declared via

```
<Property Type> <Property Name> <Value> <Units if appropriate>
```

Different properties that can be enabled for Mice Modules are described elsewhere in this document. Properties of type PropertyDouble and PropertyHep3Vector can have units. Units are defined in the CLHEP library. Units are case sensitive; MAUS will return an error message if it fails to parse units. Combinations of units such as T/m or N*m can be defined using '*' and '/' as appropriate. Properties cannot be defined more than once within the same module.

6.0.5 Child Modules

Child Modules are defined with a position, rotation and scale factor. This places, and rotates, the child volume and any fields present relative to the parent volume. Scale factor scales fields defined in the child module and any of its children. Scale factors are recursively multiplicative; that is the field generated by a child module will be scaled by the product of the scale factor defined in the parent module and all of its parents.

The child module definition looks like:

```
Module <Module File Name>
{
  PropertyHep3Vector Position <x position> <y position> <z position> <Units>
  PropertyHep3Vector Rotation <x rotation> <y rotation> <z rotation> <Units>
  PropertyDouble ScaleFactor <Value>
  <Define volume, dimensions and properties for this instance only>
}
```

MAUS searches for <Module File Name> first relative to $\${MICEFILES}/Models/Modules/$ and subsequently relative to the current working directory. The position and rotation default to 0,0,0 and the **scale factor** defaults to 1.

- Volume, Dimension and Properties of the child module can be defined at the level of the parent; in this case these values will be used only for this instance of the module.
- If no file can be found, MAUS will press on regardless, attempting to build a geometry using the information defined in the parent volume.

6.0.6 Module Hierarchy and GEANT4 Physical Volumes

MAUS enables users to place arbitrary physical volumes in a GEANT4 geometry. The formatting of MAUS is such that users are encouraged to use the GEANT4 tree structure for placing physical volumes. This is a double-edged sword, in that it provides users with a convenient interface for building geometries, but it is not a terribly safe interface.

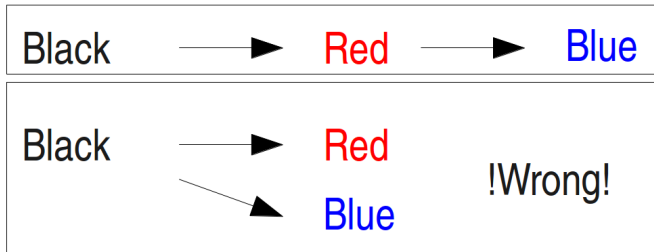
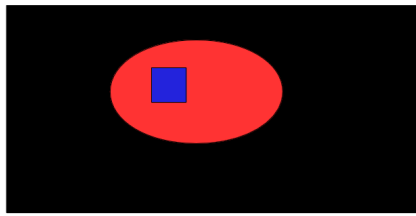

Figure 6.1: The diagram shows a schematic for a square placed inside a cylinder inside a rectangle. This nesting must be replicated in the MiceModules in order for the volumes to be correctly represented by MAUS.

Consider the cartoon of physical volumes shown above. Here there is a blue volume sitting inside a red volume sitting inside the black world volume. For the volumes to be represented properly, the module that represents the blue volume MUST be a child of the module that represents the red volume. The module that represents the red volume MUST, in turn, be a child of the module that represents the black volume, in this case the Configuration file.

What would happen if we placed the blue volume directly into the Black volume, i.e. the Configuration file? GEANT4 would silently ignore the blue volume, or the red volume, depending on the order in which they are added into the GEANT4 geometry. What would happen if we placed the blue volume overlapping the red and black volumes? The behaviour of GEANT4 is not clear in this case.

- Never allow a volume to overlap any part of another volume that is not its direct parent.

It is possible to check for overlaps by setting the datacard *CheckVolumeOverlaps* to 1.

6.0.7 A Sample Configuration File

Below is listed a sample configuration file, which is likely to be included in the file *ExampleConfiguration.dat*; the actual name is specified by the datacard MiceModel.

```
Configuration ExampleConfiguration
{
  Dimensions 1500.0 1000.0 5000.0 cm
  PropertyString Material AIR
  Substitution $MyRedColour 0.75
  Module BeamLine/SolMag.dat
  {
    Position 140.0 0.0 -2175.0 cm
```

```

    Rotation 0.0 30.0 0.0 degree
    ScaleFactor 1.
}
Module BeamLine/BendMag.dat
{
    Position 0.0 0.0 -1935.0 cm
    Rotation 0.0 15.0 0.0 degree
    ScaleFactor 1.
}
Module NoFile_Box1
{
    Volume Box
    Dimension 1.0 1.0 1.0
    Position 0.0 0.0 200.0 cm
    Rotation 0.0 15.0 0.0 degree
    PropertyString Material Galactic
    PropertyDouble RedColour $MyRedColour
}
Module NoFile_Box2}
{
    Volume Box
    Dimension 0.5 0.5 0.5*3 m //z length = 0.5*3 = 1.5 m
    Rotation 0.0 15.0 0.0 degree //Rotation relative to parent
    PropertyString Material Galactic
    PropertyDouble RedColour $MyRedColour
}
}

```

6.0.8 A Sample Child Module File

Below is listed a sample module file, which is likely to be included in the file *SolMag.dat*; the actual location is specified by the module or configuration that calls FCoil. The module contains a number of properties that define the field.

```

Module SolMag
{
    Volume Tube
    Dimensions 263.0 347.0 210.0 mm
    PropertyString Material Al
    PropertyDouble BlueColour 0.75
    PropertyDouble GreenColour 0.75
    //field}
    PropertyString FieldType Solenoid
    PropertyString FileName focus.dat
    PropertyDouble CurrentDensity 1.
    PropertyDouble Length 210. mm
    PropertyDouble Thickness 84. mm
    PropertyDouble InnerRadius 263. mm
}

```

Chapter 7

Geometry and Tracking MiceModule Properties

In general, MAUS treats physical geometry distinct from fields. Fields can be placed overlapping physical objects, or entirely independently of them, as the user desires. Properties for various aspects of the physical and engineering model of the simulation are described below. This includes properties for sensitive detectors.

7.1 General Properties

There are a number of properties that are applicable to any MiceModule.

| Property | Type | Description |
|-------------------|--------|--|
| Material | string | The material that the volume is made up from |
| Invisible | bool | Set to 1 to make the object invisible in visualisation, or 0 to make the object visible. |
| RedColour | double | Alter the colour of objects as they are visualised |
| GreenColour | double | |
| BlueColour | double | |
| G4StepMax | double | The maximum step length that Geant4 can make in the volume. Inherits values from the parent volumes. |
| G4TrackMax | double | The maximum track length and particle time of a track. Tracks outside this bound are killed. Inherits values from the parent volumes. |
| G4TimeMax | double | |
| G4KinMin | double | The minimum kinetic energy of a track. Tracks outside this bound are killed. Inherits values from the parent volumes. |
| SensitiveDetector | string | Set to the type of sensitive detector required. Possible sensitive detectors are <i>TOF</i> , <i>SciFi</i> , <i>CKOV</i> , <i>SpecialVirtual</i> , <i>Virtual</i> , <i>Envelope</i> or <i>EMCAL</i> . |
| Region | string | Allocate the volume to the named Geant4 Region. This is used for setting up production thresholds (see simulation chapter). Child modules are automatically assigned to the parent module's region. The Root module is automatically assigned to <code>DefaultRegionForTheWorld</code> . |

7.2 Sensitive Detectors

A sensitive detector (one in which hits are recorded) can be defined by including the SensitiveDetector property. When a volume is set to be a sensitive detector MAUS will automatically record tracks entering, exiting and crossing the

volume. Details such as the energy deposited by the track are sometimes also recorded in order to enable subsequent modelling of the detector response.

Some sensitive detectors use extra properties.

7.2.1 Scintillating Fibre Detector (SciFi)

7.2.2 Cerenkov Detector (CKOV)

7.2.3 Time Of Flight Counter (TOF)

7.2.4 Special Virtual Detectors

Special virtual detectors are used to monitor tracking through a particular physical volume. Normally particle tracks are written in the global coordinate system, although an alternate coordinate system can be defined. Additional properties can be used to parameterise special virtual detectors.

| Property | Type | Description |
|-------------------|----------------|---|
| ZSegmentation | int | Set the number of segments in the detector in Z, R or f. Defaults to 1. |
| PhiSegmentation | int | |
| RSegmentation | int | |
| SteppingThrough | bool | Set to true to record tracks stepping through, into, out of or across the volume. Defaults to true. |
| SteppingInto | bool | |
| SteppingOutOf | bool | |
| SteppingAcross | bool | |
| Station | int | Define an integer that is written to the output file to identify the station. Defaults to a unique integer identifier chosen by MAUS, which will be different each time the same Special Virtual is placed. |
| LocalRefRotation | Hep3 Vector | If set, record hits relative to a reference rotation in the coordinate system of the SpecialVirtual detector. |
| GlobalRefRotation | Hep3 Vector | If set, record hits relative to a reference rotation in the coordinate system of the Configuration. |
| LocalRefPosition | Hep3 Vector | If set, record hits relative to a reference position in the coordinate system of the SpecialVirtual detector. |
| GlobalRefPosition | Hep3 Vector | If set, record hits relative to a reference position in the coordinate system of the Configuration. |

7.2.5 Virtual Detectors

Virtual detectors are used to extract all particle data at a particular plane, irrespective of geometry. Virtual detectors do not need to have a physical volume. The *plane* can be a plane in z, time, proper time, or a physical plane with some arbitrary rotation and translation.

| Property | Type | Description |
|----------------------------|--------|--|
| <i>IndependentVariable</i> | String | <ul style="list-style-type: none"> • If set to <i>t</i>, particle data will be written for particles at the time defined by the <i>PlaneTime</i> property. • If set to <i>tau</i>, particle data will be written for particles at the proper time defined by the <i>PlaneTime</i> property. • If set to <i>z</i>, particle data will be written for particles crossing the module's z-position. • If set to <i>u</i>, particle data will be written for particles crossing a plane extending in <i>x</i> and <i>y</i>. |
| <i>PlaneTime</i> | Double | If <i>IndependentVariable</i> is <i>t</i> or <i>tau</i> , particle data will be written out at this time. Mandatory if <i>IndependentVariable</i> is <i>t</i> or <i>tau</i> . |
| RadialExtent | Double | If set, particles outside this radius in the plane of the detector will not be recorded by the Virtual detector. |
| GlobalCoordinates | Bool | If set to 0, particle data is written in the coordinate system of the module. Otherwise particle data is written in global coordinates. |
| MultiplePasses | String | Set how the VirtualPlane handles particles that pass through more than once. If set to Ignore, particles will be ignored on second and subsequent passes. If set to SameStation, particles will be registered with the same station number. If set to NewStation, particles will be registered with a NewStation number given by the <i>(total number of stations) + (this plane's station number)</i> , i.e. a new station number appropriate for a ring geometry. |
| AllowBackwards | Bool | Set to false to prevent backwards-going particles from being recorded. Default is true. |

7.2.6 Envelope Detectors

Envelope detectors are a type of Virtual detector that take all of the properties listed under virtual detectors, above. In addition, in the optics application they can be used to interact with the beam envelope in a special way. The following properties can be defined for Envelope Detectors *in addition to* the properties specified above for virtual detectors.

The The EnvelopeOut properties are used to make output from the envelope for use in the Optics optimiser.

| Property | Type | Description |
|--------------------------|--------|---|
| <i>EnvelopeOut1_Name</i> | String | Defines the variable name that can be used as an expression substitution at the end of each iteration, typically substituted into the Score parameters in the optimiser (see optimiser, below). |
| <i>EnvelopeOut1_Type</i> | String | Defines the type of variable that will be calculated for the substitution. Options are <ul style="list-style-type: none"> • Mean • Covariance • Standard_Deviation • Correlation • Bunch_Parameter |

| Property | Type | Description |
|------------------------------|--------|---|
| <i>EnvelopeOut1_Variable</i> | String | <p>Defines the variable that will be calculated for the substitution. Options are for Bunch_Parameter</p> <ul style="list-style-type: none"> • ○ <i>emit_6d</i> : 6d emittance ○ <i>emit_4d</i>: 4d emittance (in x-y space) ○ <i>emit_t</i>: 2d emittance (in time space) ○ <i>emit_x</i>: 2d emittance (in x space) ○ <i>emit_y</i>: 2d emittance (in y space) ○ <i>beta_4d</i>: 4d transverse beta function ○ <i>beta_t</i>: 2d longitudinal beta function ○ <i>beta_x</i>: 2d beta function (in(x space) ○ <i>beta_y</i>: 2d beta function (in y space) ○ <i>alpha_4d</i>: 4d transverse alpha function ○ <i>alpha_t</i>: 2d longitudinal alpha function ○ <i>alpha_x</i>: 2d alpha function (in(x space) ○ <i>alpha_y</i>: 2d alpha function (in y space) ○ <i>gamma_4d</i>: 4d transverse gamma function ○ <i>gamma_t</i>: 2d longitudinal gamma function ○ <i>gamma_x</i>: 2d gamma function (in(x space) ○ <i>gamma_y</i>: 2d gamma function (in y space) ○ <i>disp_x</i>: x-dispersion ○ <i>disp_y</i>: y-dispersion ○ <i>ltwiddle</i>: normalised angular momentum ○ <i>lkin</i>: standard angular momentum <p>For Mean, Standard_Deviation, Covariance and Correlation, variables should be selected from the options</p> <ul style="list-style-type: none"> • <i>x</i>: x-position • <i>y</i>:y-position • <i>t</i>: time • <i>px</i>: x-momentum • <i>py</i>: y-momentum • <i>E</i>: energy <p>For Mean, a single variable should be selected and value corresponding to the reference trajectory will be returned. For Standard_Deviation, a single variable should be selected and the 1 sigma beam size will be returned. For Covariance and Correlation, two variables should be selected separated by a comma.</p> |

| Property | Type | Description |
|----------|------|-------------|
|----------|------|-------------|

7.3 Unconventional Volumes

It is possible to define a number of volumes that use properties rather than the Dimensions keyword to define the volume size.

Volume Trapezoid

Volume Trapezoid gives a trapezoid which is not necessarily isosceles. Its dimensions are given by:

| Property | Type | Description |
|------------------|--------|----------------------|
| TrapezoidWidthX1 | Double | Gives width1 in x |
| TrapezoidWidthX2 | Double | Gives width2 in x |
| TrapezoidWidthY1 | Double | Gives height1 in y |
| TrapezoidWidthY2 | Double | Gives height2 in y |
| TrapezoidLengthZ | Double | Gives length along z |

7.3.1 Trapezoid Volume

A Trapezoid Volume is like a Wedge Volume (look visualization below) with the possibility to have different values for x width and 2 (non-zero) values for y.

7.3.2 Volume Wedge

A wedge is a triangular prism as shown in the diagram. Here the blue line extends along the positive z-axis and the red line extends along the x-axis.

| Property | Type | Description |
|------------|-------------|---|
| Dimensions | Hep3 Vector | <ol style="list-style-type: none"> 1. Width of the prism in x 2. Open end height of the prism in y 3. Length of the prism in z |

7.3.3 Volume Polycone

A polycone is a volume of rotation, defined by a number of points in r and z. The volume is found by a linear interpolation of the points.

| Property | Type | Description |
|--------------|--------|---|
| PolyconeType | string | Set to Fill to define a solid volume of rotation. Set to Cone to define a shell volume of rotation with an inner and outer surface. |
| FieldMapMode | string | The name of the file that contains the polycone data. |

7.3.4 Volume Quadrupole

Quadrupoles are defined by an empty cylinder with four further cylinders that are approximations to pole tips.

| Property | Type | Description |
|----------------|--------|---|
| PhysicalLength | double | The length of the quadrupole container. |

| Property | Type | Description |
|------------------|--------|---|
| QuadRadius | double | The distance from the quad centre to the outside of the quad. |
| PoleTipRadius | double | The distance from the quad centre to the pole tip. |
| CoilRadius | double | |
| CoilHalfWidth | double | |
| BeamlineMaterial | string | The material from which the beamline volume is made. |
| QuadMaterial | string | The material from which the quadrupole volume is made. |

7.3.5 Volume Multipole

Multipoles are defined by an empty box with an arbitrary number of cylinders that are approximations to pole tips. Poles are placed around the centre of the box with n-fold symmetry. Multipoles can be curved, in which case poles cannot be defined – only a curved rectangular aperture will be present.

| Property | Type | Description |
|----------------------------|--------|--|
| <i>ApertureCurvature</i> | double | Radius of curvature of the multipole aperture. For now curved apertures cannot have poles. Set to 0 for a straight aperture. |
| <i>ApertureLength</i> | double | Length of the multipole aperture. |
| NumberOfPoles | int | Number of poles. |
| PoleCentreRadius | double | The distance from the centre of the aperture to the centre of the cylindrical pole. |
| PoleTipRadius | double | The distance from the centre of the aperture to the tip of the cylindrical pole. |
| <i>ApertureInnerHeight</i> | double | The inner full height of the aperture. |
| <i>ApertureInnerWidth</i> | double | The inner full width of the aperture. |
| <i>ApertureOuterHeight</i> | double | The outer full height of the aperture. |
| <i>ApertureOuterWidth</i> | double | The outer full width of the aperture. |

7.3.6 Volume Boolean

Boolean volumes enable several volumes to be combined to make very sophisticated shapes from a number of elements. Elements can be combined either by union, intersection or subtraction operations. A union creates a volume that is the sum of two elements; an intersection creates a volume that covers the region where two volumes intersect each other; and a subtraction creates a volume that contains all of one volume except the region that another volume sits in.

Boolean volumes combine volumes modelled by other MiceModules (sub-modules), controlled using the properties listed below. Only the volume shape is used; position, rotation and field models etc are ignored. Materials, colours and other relevant properties are all taken only from the Boolean Volume's properties.

Note that unlike in other parts of MAUS, submodules for use in Booleans (BaseModule, BooleanModule1, BooleanModule2 ...) must be defined in a separate file, either defined in \$MICEFILES/Models/Modules or in the working directory.

Also note that visualisation of boolean volumes is rather unreliable. Unfortunately this is a feature of GEANT4. An alternative technique is to use special virtual detectors to examine hits in boolean volumes.

| Property | Type | Description |
|-------------------|--------|--|
| <i>BaseModule</i> | string | Name of the physical volume that the BooleanVolume is based on. This volume will be placed at (0,0,0) with no rotation, and all subsequent volumes will be added, subtracted or intersected with this one. |

| Property | Type | Description |
|---------------------------|----------------|--|
| <i>BooleanModule1</i> | string | The first module to add. MAUS will search for the MiceModule with path \$MICEFILES/Models/Modules/<BooleanModule1>. |
| <i>BooleanModule1Type</i> | string | The type of boolean operation to apply, either "Union", "Intersection" or "Subtraction". |
| <i>BooleanModule1Pos</i> | Hep3 Vector | The position of the new volume with respect to the Base volume. |
| <i>BooleanModule1Rot</i> | Hep3 Vector | The rotation of the new volume with respect to the Base volume. |
| <i>BooleanModuleN</i> | string | Add extra modules as required. Replace "N" with the module number. N must be a continuous series incrementing by 1 for each new module. Note that the order in which modules are added is important – (A-B) U C is different to A-(B U C). |
| <i>BooleanModuleNType</i> | string | |
| <i>BooleanModuleNPos</i> | Hep3 Vector | |
| <i>BooleanModuleNRot</i> | Hep3 Vector | |

7.3.7 Volume Sphere

A sphere is a spherical shell, with options for opening angles to make segments.

| Property | Type | Description |
|-------------------|----------------|--|
| <i>Dimensions</i> | Hep3 Vector | The x value defines the inner radius. The y value defines the outer radius of the shell. The z value is not used. |
| Phi | Hep3 Vector | The x value defines the start opening angle in phi. The y value defines the end opening angle. The z value is not used. Phi values must be in the range 0 to 360 degrees. If undefined, defaults to the range 0-360 degrees. |
| Theta | Hep3 Vector | The x value defines the start opening angle in theta. The y value defines the end opening angle. The z value is not used. Theta values must be in the range 0 to 180 degrees. If undefined, defaults to the range 0-360 degrees. |

7.4 Repeating Modules

It is possible to set up a repeating structure for e.g. a repeating magnet lattice. The RepeatModule property enables the user to specify that a particular module will be repeated a number of times, with all properties passed onto the child module, but with a new position, orientation and scale factor. Each successive repetition will be given a translation and a rotation relative to the coordinate system of the previous repetition, enabling the construction of circular and straight accelerator lattices. Additionally, successive repetitions can have fields scaled relative to previous repetitions, enabling for example alternating lattices.

| Property | Type | Description |
|--------------------------|----------------|---|
| <i>RepeatModule</i> | bool | Set to 1 to enable repeats in this module. |
| <i>NumberOfRepeats</i> | int | Number of times the module will be repeated in addition to the initial placement. |
| <i>RepeatTranslation</i> | Hep3 Vector | Translation applied to successive repeats, applied in the coordinate system of the previous repetition. |
| <i>RepeatRotation</i> | Hep3 Vector | Rotation applied to successive repeats, applied in the coordinate system of the previous repetition. |
| <i>RepeatScaleFactor</i> | double | ScaleFactor applied to successive repeats, applied relative to previous repetition's scale factor. |

| Property | Type | Description |
|----------|------|-------------|
|----------|------|-------------|

The RepeatModule2 property also enables the user to specify that a particular module will be repeated a number of times. In this case, MAUS will set a substitution variable @RepeatNumber that holds an index between 0 and NumberOfRepeats. This can be used in an expression in to provide a versatile interface between user and accelerator lattice.

| Property | Type | Description |
|------------------------|------|---|
| <i>RepeatModule2</i> | bool | Set to 1 to enable repeats in this module. |
| <i>NumberOfRepeats</i> | int | Number of times the module will be repeated in addition to the initial placement. |

7.5 Beam Definition and Beam Envelopes

The Optics application can be used to track a trajectory and associated beam envelope through the accelerator structure. Optics works by finding the Jacobian around some arbitrary trajectory using a numerical differentiation. This is used to define a linear mapping about this trajectory, which can then be used to transport the beam envelope.

A beam envelope is defined by a reference trajectory and a beam ellipse. The reference trajectory takes its position and direction from the position and rotation of the module. If no rotation is defined the reference trajectory is taken along the z -axis. The magnitude of the momentum and the initial time of the reference trajectory is defined by properties. RF cavities are phased using the reference trajectory defined here.

The beam ellipse is represented by a matrix, which can either be set using

- Twiss-style parameters in (x, px) , (y, py) and (t, E) spaces.
- Twiss-style parameters in (t, E) space and Penn-style parameters in a cylindrically symmetric (x, px, y, py) space.
- A 6x6 beam ellipse matrix where the ellipse equation is given by $\mathbf{X.T}()\mathbf{M}\mathbf{X} = 1$.

The Penn ellipse matrix is given by

$$M = \begin{pmatrix} \epsilon_L mc \frac{\beta_L}{p} & -\epsilon_L mc \alpha_L & 0 & 0 & 0 & 0 \\ & \epsilon_L mc \gamma_L p & \frac{D_x}{E} V(E) & \frac{D'_x}{E} V(E) & \frac{D_y}{E} V(E) & \frac{D'_y}{E} V(E) \\ & & \epsilon_T mc \frac{\beta_T}{p} & -\epsilon_T mc \alpha_T & 0 & -\epsilon_T mc (\frac{q}{2} \beta_T \frac{B_z}{p} - L) \\ & & & \epsilon_T mc \gamma_T p & \epsilon_T mc (\frac{q}{2} \beta_T \frac{B_z}{p} - L) & 0 \\ & & & & \epsilon_T mc \frac{\beta_T}{p} & -\epsilon_T mc \alpha_T \\ & & & & & \epsilon_L mc \gamma_T p \end{pmatrix}$$

Here L is a normalised canonical angular momentum, q is the reference particle charge, B_z is the nominal on-axis magnetic field, p is the reference momentum, m is the reference mass, ϵ_T is the transverse emittance, β_T and α_T are the transverse Twiss-like functions, ϵ_L is the longitudinal emittance and β_L and α_L are the longitudinal Twiss-like functions. Additionally D_x , D_y , D'_x and D'_y are the dispersions and their derivatives with respect to z and $V(E)$ is the variance of energy (given by the (2,2) term in the matrix above).

The Twiss ellipse matrix is given by

$$M = \begin{pmatrix} \epsilon_L mc \frac{\beta_L}{p} & -\epsilon_L mc \alpha_L & 0 & 0 & 0 & 0 \\ & \epsilon_L mc \gamma_L p & \frac{D'_x}{E} V(E) & \frac{D'_x}{E} V(E) & \frac{D'_y}{E} V(E) & \frac{D'_y}{E} V(E) \\ & & \epsilon_x mc \frac{\beta_x}{p} & -\epsilon_x mc \alpha_x & 0 & 0 \\ & & & \epsilon_x mc \gamma_x p & 0 & 0 \\ & & & & \epsilon_y mc \frac{\beta_y}{p} & -\epsilon_y mc \alpha_y \\ & & & & & \epsilon_y mc \gamma_y p \end{pmatrix}$$

Here p is the reference momentum, m is the reference mass, e_i , b_i and a_i are the emittances and Twiss functions in the (t,E) , (x,p_x) and (y,p_y) planes respectively, D_x , D_y , D'_x , D'_y are the dispersions and their derivatives with respect to z and $V(E)$ is the variance of energy (given by the (2,2) term in the matrix above).

| Property | Type | Description |
|---|--------|---|
| <i>EnvelopeType</i> | string | Set to <i>TrackingDerivative</i> to evolve a beam envelope in the Optics application. |
| <i>BeamType</i> | string | Set to <i>Random</i> to generate a beam using the parameters below for the Simulation application. Set to <i>Pencil</i> to generate a pencil beam (with no random distribution). Set to <i>ICOOL</i> , <i>Turtle</i> , <i>MAUS_PrimaryGenHit</i> or <i>G4BeamLine</i> to use a beam file. |
| <i>Pid</i> | int | The particle ID of particles in the envelope or beam. |
| <i>Time</i> | double | Set the time of the envelope reference trajectory |
| <i>Longitudinal Variable</i> | string | Set the longitudinal variable used to define the reference trajectory momentum. Options are <i>Energy</i> , <i>KineticEnergy</i> , <i>Momentum</i> and <i>ZMomentum</i> . |
| <i>Energy</i> | double | Define the value of the longitudinal variable used to calculate the mean momentum and energy. The usual relationship $E^2 + p^2 c^2 = m^2 c^4$ applies. Kinetic energy E_k is related to energy E by $E_k + m = E$. |
| <i>KineticEnergy</i> | double | |
| <i>Momentum</i> | double | |
| <i>ZMomentum</i> | double | |
| <i>EllipseDefinition</i> | string | Define the beam ellipse that will be used in calculating the evolution of the Envelope, or used to generate a beam for BeamType <i>Random</i> . Options are <i>Twiss</i> , <i>Penn</i> and <i>Matrix</i> . |
| <i>The following properties are only used if EllipseDefinition is set to Twiss</i> | | |
| <i>Emittance_X</i> | double | Emittance in each 2d subspace, (x,p_x) , (y,p_y) and (t,E) . |
| <i>Emittance_Y</i> | double | |
| <i>Emittance_L</i> | double | |
| <i>Beta_X</i> | double | Twiss b function in each 2d subspace, (x,p_x) , (y,p_y) and (t,E) . |
| <i>Beta_Y</i> | double | |
| <i>Beta_L</i> | double | |
| <i>Alpha_X</i> | double | Twiss a function in each 2d subspace, (x,p_x) , (y,p_y) and (t,E) . |
| <i>Alpha_Y</i> | double | |
| <i>Alpha_L</i> | double | |
| <i>The following properties are only used if EllipseDefinition is set to Matrix</i> | | |
| <i>Covariance(t,t)</i> | double | Set the 6x6 matrix that will be used in the to define the beam ellipse. Covariances should be covariances of elements of the matrix (x,P_x,y,P_y,t,E) . This must be a positive definite matrix, i.e. determinant > 0 . Note that this means that at least the 6 terms on the diagonal must be defined. Other terms default to 0. |
| <i>Covariance(t,E)</i> | double | |
| <i>Covariance(t,x)</i> | double | |
| ... | double | |
| <i>Covariance(Py,Py)</i> | double | |
| | | |

| Property | Type | Description |
|---|--------|--|
| <i>The following properties are only used if EllipseDefinition is set to Penn</i> | | |
| <i>Emittance_T</i> | double | Transverse emittance for the 4d (x,px,y,py) subspace. |
| <i>Emittance_L</i> | double | Longitudinal emittance for the 2d (t,E) subspace. |
| <i>Beta_T</i> | double | Transverse beta for the 4d (x,px,y,py) subspace. |
| <i>Beta_L</i> | double | Longitudinal beta for the 2d (t,E) subspace. |
| <i>Alpha_T</i> | double | Transverse alpha for the 4d (x,px,y,py) subspace. |
| <i>Alpha_L</i> | double | Longitudinal alpha for the 2d (t,E) subspace. |
| <i>Normalised AngularMomentum</i> | double | Normalised angular momentum for the transverse phase space. |
| Bz | double | Nominal magnetic field on the reference particle. |
| <i>The following properties are used if EllipseDefinition is set to Penn or Twiss</i> | | |
| Dispersion_X | double | Dispersion in x (x-energy correlation). |
| Dispersion_Y | double | Dispersion in y (y-energy correlation). |
| DispersionPrime_X | double | D' in x (Px-energy correlation). |
| DispersionPrime_Y | double | D' in y (Py-energy correlation). |
| <i>The following properties are only relevant for generating a beam envelope</i> | | |
| RootOutput | string | Output file name for writing output beam envelope in ROOT binary format. |
| LongTextOutput | string | Output file name for writing output beam envelope in string format. |
| ShortTextOutput | string | Output file name for writing output beam envelope in string format. This abbreviated output omits some of the fields that are present in LongTextOutput files. |
| BeamOutput | string | If a BeamType is defined, this property controls the file name to which beam data is written. |
| Delta_t | double | Offset in time used for calculating numerical derivatives. Default is 0.1 ns. |
| Delta_E | double | Offset in energy used for calculating numerical derivatives. Default is 1 MeV. |
| Delta_x | double | Offset in x position used for calculating numerical derivatives. Default is 1 mm. |
| Delta_Px | double | Offset in x momentum used for calculating numerical derivatives. Default is 1 MeV/c. |
| Delta_y | double | Offset in y position used for calculating numerical derivatives. Default is 1 mm. |
| Delta_Py | double | Offset in y momentum used for calculating numerical derivatives. Default is 1 MeV/c. |
| Max_Delta_t | double | Maximum offsets when polyfit algorithm is used. In some cases the offset can keep increasing without limit unless these maximum offsets are defined. Default is no limit. |
| Max_Delta_E | double | |
| Max_Delta_x | double | |
| Max_Delta_Px | double | |
| Max_Delta_y | double | |
| Max_Delta_Py | double | |
| <i>The following properties are only relevant for generating a particle beam</i> | | |
| UseAsReference | Bool | If set to true and the datacard <i>FirstParticleIsReference</i> is set to 0, the first event in the Module will be used as the reference particle that sets cavity phases. This particle will then have the mean trajectory (i.e. no gaussian distribution). |
| <i>BeamFile</i> | string | If the BeamType is <i>ICOOL</i> , <i>Turtle</i> , <i>MAUS_PrimaryGenHit</i> or <i>G4BeamLine</i> , this property defines the name of the file containing tracks for MAUS. |
| NumberOfEvents | int | Set the maximum number of events to take from this module. If other modules are defined, MAUS will iterate over the modules until it the datacard <i>numEvs</i> is reached or all modules have been run to <i>NumberOfEvents</i> . Default is for MAUS to keep tracking from the first module it finds until <i>numEvs</i> is reached. |

| Property | Type | Description |
|----------|------|-------------|
|----------|------|-------------|

7.6 Optimiser

It is possible to define an optimiser for use in the Optics application. The optimiser enables the user to vary parameters in the MiceModule file and try to find some optimum setting. For each value of the parameters, MAUS Optics will calculate a score; the optimiser attempts to find a minimum value for this score.

| Property | Type | Description |
|-------------------------|--------|--|
| <i>Optimiser</i> | string | Controls the function used for optimising. For now Minuit is the only available option. |
| <i>Algorithm</i> | string | For <i>Minuit</i> optimiser, controls the <i>Minuit</i> algorithm used. In general Simplex is a good option to use here. An alternative is Migrad. See Minuit documentation (for example at http://root.cern.ch/root/html/TMinuit.html) for further information. Minuit attempts to minimise the score function defined by the Score properties. |
| <i>NumberOfTries</i> | int | Maximum number of iterations MAUS will make in order to find the optimum value. |
| <i>StartError</i> | double | Guess at the initial error in the score. |
| <i>EndError</i> | double | Required final error in the score for the optimisation to converge successfully. |
| RebuildSimulation | bool | Set to False to tell MAUS not to rebuild the simulation on each iteration. This should be used to speed up the optimiser when a parameter is used that does not change the field maps. Default is true. |
| <i>Parameter1_Start</i> | double | Seed value for the parameter, that is used in the first iteration. |
| <i>Parameter1_Name</i> | string | Name of the parameter. This name is used as an expression substitution variable elsewhere in the code and should start with @. See Expression Substitutions above for details on usage of expression substitutions. |
| <i>Parameter1_Delta</i> | double | Estimated initial error on the parameter. Default is 1. |
| <i>Parameter1_Fixed</i> | bool | Set to true to fix the parameter (so that it is excluded from the optimisation). Default is false. |
| <i>Parameter1_Min</i> | double | If required, set to the minimum value that the parameter can hold. |
| <i>Parameter1_Max</i> | double | If required, set to the maximum value that the parameter can hold. |
| <i>Parameter2_Start</i> | ... | Define an arbitrary number of parameters. Parameters must be numbered consecutively, and each parameter must have at least the start value and name defined. The optimiser will attempt to optimise against a score that is calculated by summing the Score1, Score2,... parameters on each iteration. |
| ... | ... | |
| <i>Parameter2_Max</i> | ... | |
| <i>Score1</i> | double | |
| <i>Score2</i> | ... | |
| ... | ... | |

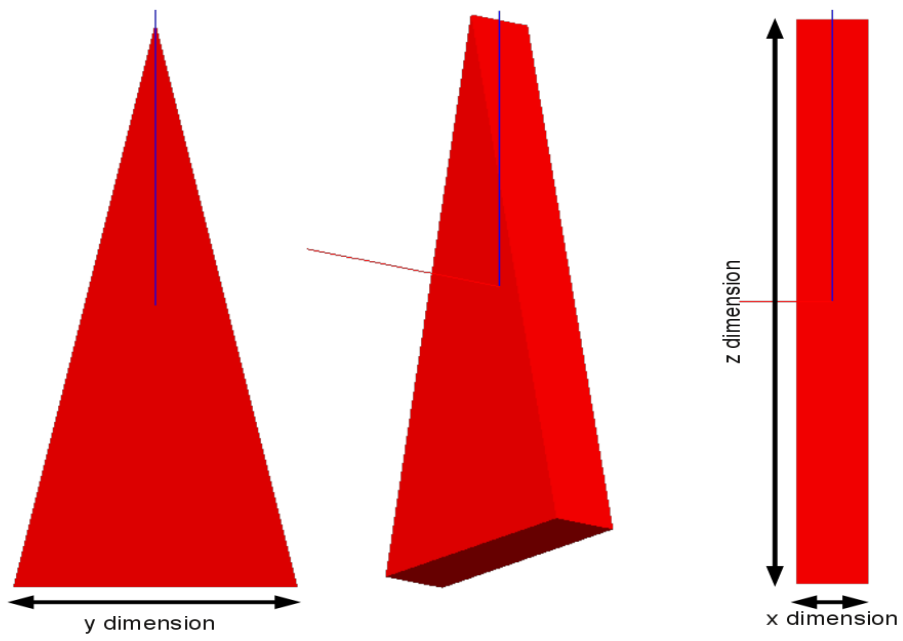

Figure 7.1: Schematic of the geometry of a Wedge volume.

Chapter 8

Field Properties

Invoke a field using `PropertyString FieldType <fieldtype>`. The field will be placed, normally centred on the `MiceModule` `Position` and with the appropriate `Rotation`. Further options for each field type are specified below, and relevant datacards are also given. If a `fieldtype` is specified some other properties must also be specified, while others may be optional, usually taking their value from defaults specified in the datacards. Only one `fieldtype` can be specified per module. However, fields from multiple modules are superimposed, each transformed according to the `MiceModule` specification. This enables many different field configurations to be simulated using MAUS.

To use BeamTools fields, datacard `FieldMode Full` must be set. This is the default.

| Property | Type | Description |
|------------------|--------|---|
| <i>FieldType</i> | string | Set the field type of the <code>MiceModule</code> . |

8.0.1 FieldType CylindricalField

Sets a constant magnetic field in a cylindrical region symmetric about the z-axis of the module.

| Property | Type | Description |
|----------------------|----------------|---|
| <i>ConstantField</i> | Hep3 Vector | The magnetic field that will be placed in the region. |
| <i>Length</i> | double | The physical extent of the region. |
| <i>FieldRadius</i> | double | |

8.0.2 FieldType RectangularField

Sets a constant magnetic field in a rectangular region.

| Property | Type | Description |
|----------------------|----------------|---|
| <i>ConstantField</i> | Hep3 Vector | The magnetic field that will be placed in the region. |
| <i>Length</i> | double | The physical extent of the region. |
| <i>Width</i> | double | |
| <i>Height</i> | double | |

| Property | Type | Description |
|----------|------|-------------|
|----------|------|-------------|

8.0.3 FieldType Solenoid

MAUS simulates solenoids using a series of current sheets. The field for each solenoid is written to a field map on a rectangular grid and can then be reused. The field from each current sheet is calculated using the formula for current sheets detailed in MUCOOL Note 281, *Modeling solenoids using coil, sheet and block conductors*.

| Property | Type | Description |
|-------------------------|--------|--|
| <i>FileName</i> | string | Read or write solenoid data to the filename. If different modules have the same filename, MAUS assumes they are the same. |
| FieldMapMode | string | If set to Read, MAUS will attempt to read existing data from the FileName. If set to Write, MAUS will generate new data and write it to the FileName. If set to Analytic, MAUS will calculate fields directly without interpolating. If set to WriteDynamic acts as in Write except the grid extent and grid spacing at each point is chosen dynamically to some tolerance defined in the FieldTolerance property. Takes default from datacard SolDataFiles (Write). |
| <i>Length</i> | double | Coil physical parameters. Only used in Write/Analytic mode where they are mandatory. |
| <i>Thickness</i> | double | |
| <i>InnerRadius</i> | double | |
| <i>CurrentDensity</i> | double | |
| ZExtentFactor | double | Field map extends to length + ZExtentFactor*innerRadius in Write mode. Takes default from datacard SolzMapExtendFactor (10.). Map size is chosen dynamically in WriteDynamic mode. |
| RExtentFactor | double | Field map extends to radius RExtentFactor*innerRadius in Write mode. Takes default from datacard SolrMapExtendFactor (2.018...). Avoid allowing grid nodes to fall on sheets. |
| NumberOfZCoords | int | Number of coordinates in z in field map grid in Write mode. Takes default from datacard NumberNodesZGrid (500). |
| NumberOfRCoords | int | Number of coordinates in r in field map grid in Write mode. Takes default from datacard NumberNodesRGrid (100). |
| NumberOfSheets | int | Number of sheets used to calculate the field. Takes default from datacard DefaultNumberOfSheets (10). |
| <i>FieldTolerance</i> | double | Mandatory when FieldMapMode is WriteDynamic. If field map mode is write dynamic, this datacard controls the tolerance on errors in the field with which the field grid and the grid extent will be chosen. |
| Interpolation Algorithm | string | Choose the interpolation algorithm. Options are BiLinear for a linear interpolation in r and z , or LinearCubic for a linear interpolation in r and a cubic spline in z . Default is LinearCubic. |
| IsAmalgamated | bool | Set to 1 to add the coil to CoilAmalgamation parent field (see below). |

8.0.4 FieldType FieldAmalgamation

During tracking, MAUS stores a list of fields and for each one MAUS checks to see if tracking is performed through a particular field map's bounding box. This can be slow if a large number of fields are present. One way to speed this up is to store contributions from many coils in a single CoilAmalgamation. A CoilAmalgamation searches through child modules for solenoids with PropertyBool IsAmalgamated set to true. If it finds such a coil, it will add the field generated by the solenoid to its own field map and disable the coil.

| Property | Type | Description |
|-------------------------|--------|---|
| <i>Length</i> | double | The Length of the field map generated by the CoilAmalgamation. |
| <i>RMax</i> | double | The maximum radius of the field map generated by the CoilAmalgamation. |
| Interpolation Algorithm | string | Choose the interpolation algorithm. Options are BiLinear for a linear interpolation in r and z , or LinearCubic for a linear interpolation in r and a cubic spline in z . Default is LinearCubic. |
| <i>ZStep</i> | double | Step size of the field map generated by the CoilAmalgamation. |
| <i>RStep</i> | double | |

8.0.5 FieldType DerivativesSolenoid

This is an alternative field model for solenoids that uses a power law expansion of the on-axis magnetic field and its derivatives, and an exponential fall-off for the fringe field. The fringe field is defined in the same way as other end fields, but note that HardEdged end field type is not available for solenoids and will result in an error.

| Property | Type | Description |
|-------------------|--------|--|
| <i>PeakField</i> | double | Nominal peak field of the solenoid. |
| <i>ZMax</i> | double | Maximum z-half length of the solenoid bounding box in the local coordinate system of the magnet. |
| <i>RMax</i> | double | Maximum radius of the solenoid bounding box in the local coordinate system of the magnet. |
| <i>MaxEndPole</i> | int | Maximum derivative used in calculating the end field of the solenoid. |

8.0.6 Phasing Models

MAUS has a number of models for phasing RF cavities.

When CavityMode is Unphased, MAUS attempts to phase the cavity itself. When using CavityMode Unphased MAUS needs to know when particles enter, cross the middle, and leave cavities. To phase a cavity, MAUS builds a virtual detector in the centre of the cavity that is used for phasing and then fires a reference particle through the system. Stochastic processes are always disabled during this process, while mean energy loss can be disabled using the datacard ReferenceEnergyLossModel. If a reference particle crosses a plane through the centre of a cavity, it sets the phase of the cavity to the time at which the particle crosses.

The field of the cavity during phasing is controlled by the property Field-DuringPhasing. There are four modes:

- *None*: Cavity fields are disabled during phasing
- *Electrostatic*: An electrostatic field with no positional dependence given by $\text{PeakEField} \cdot \sin(\text{ReferenceParticlePhase})$ is enabled during phasing.
- *TimeVarying*: A standard time varying field is applied during phasing, initially with arbitrary phase relative to the reference particle. MAUS uses a Newton-Raphson method to find the appropriate reference phase iteratively, with tolerance set by the datacard PhaseTolerance.
- *EnergyGainOptimised*: A standard time varying field is applied during phasing, initially with arbitrary phase and peak field relative to the reference particle. MAUS uses a 2D Newton-Raphson method to find the appropriate reference phase and peak field iteratively, so that the reference particle crosses the cavity centre with phase given by property ReferenceParticlePhase and gains energy over the whole cavity given by

property EnergyGain with tolerances set by the datacards PhaseTolerance and RFDeltaEnergyTolerance.

8.0.7 Tracking Stability Around RF Cavities

Usually RF cavities have little or no fringe field, and this can lead to some instability in the tracking algorithms. When MAUS makes a step into an RF cavity volume, the tracking algorithms tend to smooth out a field in a non-physical way. This can be prevented by either (i) making the step size rather small in the RF cavity or (ii) forcing MAUS to stop tracking by adding a physical volume at the entrance of the RF cavity (a window, typically made of vacuum). Doing this should improve stability of tracking.

8.0.8 FieldType PillBox

Sets a PillBox field in a particular region. MAUS represents pillboxes using a sinusoidally varying TM010 pill box field, with non-zero field vector elements given by

$$B_\phi = J_1(k_r r) \cos(\omega t)$$

$$E_z = J_0(k_r r) \cos(\omega t)$$

Here J_n are Bessel functions and k_r is a constant. See, for example, SY Lee VI.1. All other fields are 0.

| Property | Type | Description |
|---------------------------|--------|--|
| <i>Length</i> | double | Length of the region in which the field is present. |
| <i>CavityMode</i> | string | Phasing mode of the cavity - options are Phased, Unphased and Electrostatic. |
| <i>FieldDuringPhasing</i> | string | Controls the field during cavity phasing - options are None, Electrostatic, TimeVarying and EnergyGainOptimised. |
| <i>EnergyGain</i> | double | WhenFieldDuringPhasing is set to EnergyGainOptimised, controls the peak electric field. |
| <i>Frequency</i> | double | The cavity frequency. |
| <i>PeakEField</i> | double | The peak field of the cavity. Not used when the FieldDuringPhasing is EnergyGainOptimised. |
| <i>TimeDelay</i> | double | In Phased mode the time delay (absolute time) of the cavity. |
| PhasingVolume | string | Set to SpecialVirtual to make the central volume a special virtual. |
| ReferenceParticle Energy | double | In Electrostatic mode, MAUS calculates the peak field and the field the reference particle sees using a combination of the reference particle energy, charge and phase. Take defaults from datacards NominalKineticEnergy and Muon-Charge |
| ReferenceParticle Charge | double | |
| ReferenceParticle Phase | double | MAUS tries to phase the field so that the reference particle crosses the cavity at ReferenceParticlePhase (units are angular). 0° corresponds to no energy gain, 90° corresponds to operation on-crest. Default from datacard rfAccelerationPhase. |

8.0.9 FieldType RFFieldMap

Sets a cavity with an RF field map in a particular region. RFFieldMap uses the same phasing algorithm as described above.

| Property | Type | Description |
|-------------------|--------|--|
| <i>Length</i> | double | Length of the region in which the field is present. |
| <i>CavityMode</i> | string | Phasing mode of the cavity - options are Phased and Unphased. RFFieldMaps cannot operated in Electrostatic mode. |

| Property | Type | Description |
|---------------------------|--------|--|
| <i>FieldDuringPhasing</i> | string | Controls the field during cavity phasing – options are None, Electrostatic, TimeVarying and EnergyGainOptimised. |
| <i>EnergyGain</i> | double | WhenFieldDuringPhasing is set to EnergyGainOptimised, controls the peak electric field. |
| <i>Frequency</i> | double | The cavity frequency. |
| <i>PeakEField</i> | double | The peak field of the cavity. Not used when the FieldDuringPhasing is EnergyGainOptimised. |
| <i>TimeDelay</i> | double | In Phased mode the time delay (absolute time) of the cavity. |
| PhasingVolume | string | Set to SpecialVirtual to make the central volume a special virtual. |
| ReferenceParticle Energy | double | In Electrostatic mode, MAUS calculates the peak. field and the field the reference particle sees using a combination of the reference particle energy, charge and phase. Take defaults from datacards NominalKineticEnergy and MuonCharge |
| ReferenceParticle Charge | double | |
| ReferenceParticle Phase | double | MAUS tries to phase the field so that the reference particle crosses the cavity at ReferenceParticlePhase (units are angular). 0° corresponds to no energy gain, 90° corresponds to operation on-crest. Default from datacard rfAccelerationPhase. |
| <i>FileName</i> | string | The file name of the field map file. |
| <i>FileType</i> | string | The file type of the field map. Only supported option is SuperFishSF7. |

8.0.10 FieldType Multipole

Creates a multipole of arbitrary order. Fields are generated using either a hard edged model, with no fringe fields at all; or an Enge model similar to ZGoubi and COSY. In the former case fields are calculated using a simple polynomial expansion. In the latter case fields are calculated using the polynomial expansion with an additional exponential drop off. Fields can be superimposed onto a bent coordinate system to generate a sector multipole with arbitrary fixed radius of curvature.

Unlike most other field models in MAUS, the zero position corresponds to the center of the entrance of the multipole; and the multipole extends in the +z direction.

The method to define end fields is described in the section EndFieldTypes below

| Property | Type | Description |
|----------------------|--------|---|
| <i>Pole</i> | int | The reference pole of the magnet. 1=dipole, 2=quadrupole, 3=sextupole etc. |
| <i>FieldStrength</i> | double | Scale the field strength in the good field region. For dipoles, this sets the dipole field; for quadrupoles this sets the field gradient. Note that for some end field settings there can be no good field region (e.g. if the end length is $> \tilde{\sim}$ centre length). |
| <i>Height</i> | double | Height of the field region. |
| <i>Width</i> | double | Width or delta radius of the field region. |
| <i>Length</i> | double | Length of the field along the bent trajectory. |
| EndFieldType | string | Set to HardEdged to disable fringe fields. Set to Enge or Tanh to use those models, as described elsewhere. Default is HardEdged. |
| CurvatureModel | string | Choose the model for curvature. Straight forces no curvature. Constant gives a constant radius of curvature; StraightEnds gives a constant radius of curvature along the length of the multipole with straight end fields beyond this length. MomentumBased gives radius of curvature determined by a momentum and a total bending angle. |

| Property | Type | Description |
|---------------------|--------|---|
| ReferenceCurvature | double | Radius of curvature of the magnet in Constant or StraightEnds mode. Set to 0 for a straight magnet. Default is 0. |
| ReferenceMomentum | double | Reference momentum used to calculate the radius of curvature of a dipole in MomentumBased mode. Default is 0. |
| <i>BendingAngle</i> | double | The angle used to calculate the radius of curvature of a dipole in MomentumBased mode. Note that this is mandatory in MomentumBased mode. |

8.0.11 FieldType CombinedFunction

This creates superimposed dipole, quadrupole and sextupole fields with a common radius of curvature. The field is intended to mimic the first few terms in a multipole expansion of a field like

$$B(y = 0) = B_0 \left(\frac{r}{r_0} \right)^k$$

The field index is a user defined parameter, while the dipole field and radius of curvature can either be defined directly by the user or defined in terms of a reference momentum and total bending angle. Fields are calculated as in the multipole field type defined above.

| Property | Type | Description |
|---------------------|--------|---|
| <i>Pole</i> | int | The reference pole of the magnet. 1=dipole, 2=quadrupole, 3=sextupole etc. |
| <i>BendingField</i> | double | The nominal dipole field B_0 . Note that this is mandatory in all cases except where CurvatureModel is MomentumBased, when the BendingAngle and ReferenceMomentum is used to calculate the dipole field instead. |
| <i>FieldIndex</i> | double | The field index k . |
| <i>Height</i> | double | Height of the field region. |
| <i>Width</i> | double | Width or delta radius of the field region. |
| <i>Length</i> | double | Length of the field along the bent trajectory. |
| EndFieldType | string | Set to HardEdged to disable fringe fields. Set to Enge or Tanh to use those models, as described elsewhere. Default is HardEdged. |
| CurvatureModel | string | Choose the model for curvature. Straight forces no curvature. Constant gives a constant radius of curvature; StraightEnds gives a constant radius of curvature along the length of the multipole with straight end fields beyond this length. MomentumBased gives radius of curvature determined by a momentum and a total bending angle. |
| ReferenceCurvature | double | Radius of curvature of the magnet in Constant or StraightEnds mode. Set to 0 for a straight magnet. Default is 0. |
| ReferenceMomentum | double | Reference momentum used to calculate the radius of curvature of a dipole in MomentumBased mode. Default is 0. |
| <i>BendingAngle</i> | double | The angle used to calculate the radius of curvature of a dipole in MomentumBased mode. Note that this is mandatory in MomentumBased mode. |

8.0.12 EndFieldTypes

In the absence of current sources, the magnetic field can be calculated from a scalar potential using the standard relation

$$\vec{B} = \nabla V_n$$

The scalar magnetic potential of the n^{th} -order multipole field is given by

$$V_n = \sum_{q=0}^{q_m} \sum_{m=0}^n n!^2 \frac{G^{(2q)}(s)(r^2 + y^2)^q \sin\left(\frac{m\pi}{2}\right) r^{n-m} y^m}{4^q q!(n+q)!m!(n-m)!}$$

where $G(s)$ is either the double Enge function,

$$G(s) = E[(x - x_0)/\lambda] + E[(-x - x_0)/\lambda] - 1$$

$$E(s) = \frac{B_0}{R_0^n} \frac{1}{1 + \exp(C_1 + C_2s + C_3s^2 + \dots)}$$

or $G(s)$ is the double tanh function,

$$G(s) = \tanh[(x + x_0)/\lambda]/2 + \tanh[(x - x_0)/\lambda]/2$$

and (r, y, s) is the position vector in the rotating coordinate system. Note that here s is the distance from the nominal end of the field map.

| Property | Type | Description |
|--|--------|---|
| EndFieldType | string | Set to HardEdged to disable fringe fields. Set to Enge or Tanh to use those models, as described elsewhere. Default is HardEdged. |
| <i>The following properties are used for EndFieldType Tanh</i> | | |
| EndLength | double | Set the l parameter that defines the rapidity of the field fall off. |
| CentreLength | double | Set the x_0 parameter that defines the length of the flat field region. |
| MaxEndPole | int | Set the maximum pole that will be calculated – should be larger than the multipole pole. |
| <i>The following properties are used for EndFieldType Enge</i> | | |
| EndLength | double | Set the l parameter that defines the rapidity of the field fall off. |
| CentreLength | double | Set the x_0 parameter that defines the length of the flat field region. |
| MaxEndPole | int | Set the maximum pole that will be calculated – should be larger than the multipole pole. |
| Enge1 | double | Set the parameters C_i as defined in the Enge function above. |
| Enge2 | double | |
| ... | double | |
| EngeN | double | |

8.0.13 FieldType MagneticFieldMap

Reads or writes a magnetic field map in a particular region. Two sorts of field maps are supported; either a 2d field map, in which cylindrical symmetry is assumed, or a 3d field map.

For 2d field maps, MAUS reads or writes a file that contains information about the radial and longitudinal field components. This is intended for solenoidal field maps where only radial and longitudinal field components are present. Note that in write mode, MAUS assumes cylindrical symmetry of the fields. In this case, MAUS writes the x and z components of the magnetic field at points on a grid in x and z . Fields with an electric component are excluded from this summation.

For 3d field maps, MAUS reads a file that contains the position and field in cartesian coordinates and performs a linear interpolation. This requires quite large field map files; the file size can be slightly reduced by using certain symmetries, as described below. It is currently not possible to write 3d field maps.

| Property | Type | Description |
|--------------|--------|--|
| FieldMapMode | string | Set to Read to read a field map; and Write to write a field map. |
| FileName | string | The file name that is used for reading or writing. |
| FileType | string | The file format. Supported options in Read mode are MAUS <code>text</code> , MAUS <code>binary</code> , g4 <code>beamline</code> , icool, g4 <code>bl3dGrid</code> . Only MAUS <code>text</code> is supported in Write mode. Default is MAUS <code>text</code> . |

| Property | Type | Description |
|--------------|--------|--|
| Symmetry | string | Symmetry option for g4bl3dGrid file type. Options are None, Dipole or Quadrupole. None uses the field map as is, while Dipole and Quadrupole reflect the octant between the positive x , y and z axes to give an appropriate field for a dipole or quadrupole. |
| <i>ZStep</i> | double | Step size in z and r . Mandatory in Write mode but not used in Read mode (where step size comes from the map file). |
| <i>RStep</i> | double | |
| <i>ZMin</i> | double | Upper and lower bounds in z and r . Mandatory in Write mode but not used in Read mode (where boundaries come from the map file). |
| <i>ZMax</i> | double | |
| <i>RMin</i> | double | |
| <i>RMax</i> | double | |

Some file formats are described below. I am working towards making the file format more generic and hence possibly easier to use, but backwards compatibility will hopefully be maintained.

MAUStext Field Map Format

The native field map format used by MAUS in text mode is described below.

```
# GridType = Uniform N = number_rows
# Z1 = z_start Z2 = z_end dZ = z_step
# R1 = r_start R2 = r_end dR = r_step
Bz_Values Br_Values
... ..
<Repeat as necessary>
```

In this mode, field maps are represented by field values on a regular 2d grid that is assumed to have solenoidal symmetry, i.e. cylindrical symmetry with no tangential component.

| Name | Type | Description |
|-------------|--------|--|
| number_rows | double | Number of rows in the field map file. |
| z_start | double | Position of the grid start along the z axis. |
| z_end | double | Position of the grid end along the z axis. |
| z_step | double | Step size in z . |
| r_start | double | Position of the grid start along the r axis. |
| r_end | double | Position of the grid end along the r axis. |
| r_step | double | Step size in r . |
| Bz_Values | double | B_z field value. |
| Br_Values | double | B_r field value. |

g4bl3dGrid Field Map Format

The file format for 3d field maps is a slightly massaged version of a file format used by another code, g4beamline. In this mode, field maps are represented by field values on a regular cartesian 3d grid.

```
number_x_points number_y_points number_z_points global_scale
1 X [x_scale]
2 Y [y_scale]
3 Z [z_scale]
4 BX [bx_scale]
5 BY [by_scale]
6 BZ [bz_scale]
0
X_Values Y_Values Z_Values Bx_values By_values Bz_values
```

... ..

<Repeat as necessary>

where text in bold indicates a value described in the following table

| Name | Type | Description |
|-----------------|-------------|---|
| number_x_points | double | Number of points along x axis. |
| number_y_points | double | Number of points along y axis. |
| number_z_points | double | Number of points along z axis. |
| global_scale | double | Global scale factor applied to all x, y, z and Bx, By, Bz values. |
| x_scale | double | Scale factor applied to all x values. |
| y_scale | double | Scale factor applied to all y values. |
| z_scale | double | Scale factor applied to all z values. |
| bx_scale | double | Scale factor applied to all Bx values. |
| by_scale | double | Scale factor applied to all By values. |
| bz_scale | double | Scale factor applied to all Bz values. |
| X_Values | double | List (column) of each x value. |
| Y_Values | double | List (column) of each y value. |
| Z_Values | double | List (column) of each z value. |
| Bx_Values | double | List (column) of each Bx value. |
| By_Values | double | List (column) of each By value. |
| Bz_Values | double | List (column) of each Bz value. |

Chapter 9

TOF Detector

This chapter describes the time-of-flight (TOF) simulation and reconstruction software. The simulation is designed to produce digits similar to “real data” and the reconstruction is agnostic about whether the digits are from simulation or data acquisition.

9.1 Simulation

- **Geometry**

For the most upstream TOF – TOF0 – to be simulated, it is essential that the z where the beam starts be upstream of the detector.

In the standard Step VI geometry as described in `Stage6.dat`, this is at -14200 mm and for the Step IV geometry described in `Stage4.dat` it is at 2773 mm

The internal geometry of the TOF detector and the positioning of the slabs are defined in the MiceModules representation. The numbering convention is the same as that for the DAQ and is described in MICE-Notes 251 and 286. It is worth keeping in mind the plane numbering convention since the current naming scheme is suboptimal:

- `station` refers to the TOF station – TOF0, TOF1, TOF2
- `plane` refers to the horizontal/vertical planes within a station
- `plane 0` means horizontal slabs – slabs are oriented horizontally. They measure y
- `plane 1` means vertical slabs – slabs are oriented vertically. They measure x

The z locations of TOF0 and TOF1 are specified in the `Beamline.dat` file and the z of TOF2 is specified in the main geometry description file, for e.g. `Stage6.dat`

- **Hits**

GEANT hits are generated for all tracks which pass through a TOF slab. “True” TOF hits are described by the `MAUS::Hit` class and contain the GEANT4 information prior to digitization. The members of the class are listed below.

Table 9.1: True TOF hit class members.
The GEANT TOF hits are encoded with the following information.

| Name | Meaning |
|------------------|---|
| channel_id | Class TOFChannelId* contains station, plane, slab |
| energy_deposited | double – energy deposited by track in the slab |
| position | ThreeVector – x, y, z of hit at the slab |
| momentum | ThreeVector – p_x, p_y, p_z of particle at slab |
| time | double – hit time |
| charge | double – PDG charge of particle that produced this hit |
| track_id | G4Track – ID of the GEANT track that produced this hit |
| particle_id | ThreeVector – PDG code of the particle that produced this hit |

9.1.1 Digitization

Each GEANT hit in the TOF is associated with a slab based on the geometry described in the TOF MiceModules. If a hit’s position does not correspond to a physical slab (for instance if the hit is outside the fiducial volume) the hit is not digitized. The energy deposited in the slab and the hit time are then digitized as described below.

- **Charge digitization** The energy deposited by a hit in a slab is first converted to units of photoelectrons. The photoelectron yield from a hit is attenuated by the distance from the hit to the PMT, then smeared by the photoelectron resolution. The yields from all hits in a given slab are then added and the summed photoelectron yield is converted to ADC (In principle, this should be done not on an event-by-event basis but rather on a trigger-basis. In the absence of a real trigger, all hits in a slab are now merged)
- **Time digitization** The hit time is propagated to the PMTs at either end of the slab. The speed of light in the scintillator, based on earlier calibration, is controlled by the TOFscintLightSpeed data card. The time is then smeared by the PMT time resolution and converted to TDC.

After converting the energy deposit to ADC and the time to TDC, the TDC values are “uncalibrated” so that at the reconstruction stage they can be corrected just as is done with real data.

The data cards that control the digitization are listed in Table 9.2.

NOTE: Do not modify the default values.

9.2 Reconstruction

The reconstruction software treats both data and Monte Carlo the same way. In the case of real data, the input to the reconstruction chain is TOF Digits (MapCppTOFDigit) and in the case of Monte Carlo it is the digitized information from MapCppTOFMCDigitizer.

- **Digits (MapCppTOFDigit, MapCppTOFMCDigitizer)** Digits are formed from the V1724 ADCs and V1290 TDCs.

Table 9.2: Data cards for TOF digitization.

| Name | Meaning | Default |
|-------------------------|--------------------------------------|-----------|
| TOFconversionFactor | conversion | 0.005 MeV |
| TOFpmtTimeResolution | resolution for smearing the PMT time | 0.1 ns |
| TOFattenuationLength | light attenuation in slabs | 1400 mm |
| TOFadcConversionFactor | conversion from charge to ADC | 0.125 |
| TOFtdcConversionFactor | conversion from time to TDC | 0.025 |
| TOFpmtQuantumEfficiency | PMT collection efficiency | 0.25 |
| TOFscintLightSpeed | propagation speed in slab | 170 mm/ns |

- **Slab Hits** (MapCppTOFSlabHits) The SlabHits routine takes individual PMT digits and associates them to reconstruct the hit in the slab. All PMT digits are considered. If there are multiple hits associated with a PMT, the hit which is earliest in time is taken to be the real hit. Then, if both PMTs on a slab have hits, the SlabHit is formed. The TDC values are converted to time (ToftdcConversionFactor) and the hit time and charge associated with the slab hit are taken to be the average of the two PMT times and charges respectively. In addition, the charge product of the PMT charges is also formed.
- **Space Points** (MapCppTOFSpacePoints) A space point pixel in the TOF is a combination of x and y slab hits. All combinations of x and y slab hits in a given station are considered. If the station is a trigger station, an attempt is made to find the “trigger pixel” – i.e. the x, y combination that triggered this event. This is done by applying calibration corrections to the slab hits, and then asking if the average time in this pixel is consistent with the trigger within some tolerance. In other words, if t_x and t_y are the times corresponding to the x and y slab hits, is $\frac{t_{x,calib}+t_{y,calib}}{2} < t_{triggercut}$? If no x, y combination produces a trigger pixel, the space point reconstruction stops and no space points are formed. This is because to apply the calibration corrections to the slab hit times, it is essential know the trigger pixel.

Once a trigger pixel is found, all x, y slab hit combinations are again treated as space point candidates. The calibration corrections are applied to these hit times. If $|t_x - t_y|$ is consistent with the resolution of the detector, the combination is said to be a space point. The space point thus formed contains the following information

```
This is used by the reconstruction of the TOF detectors| #TOF_cabling_file = "/files/cabling/TOFChannelMap.txt"
#TOF_TW_calibration_file = "/files/calibration/tofcalibTW_dec2011.txt"
#TOF_T0_calibration_file = "/files/calibration/tofcalibT0_trTOF1_dec2011.txt"
#TOF_T0_calibration_file = "/files/calibration/tofcalibT0_trTOF0.txt"
#TOF_Trigger_calibration_file = "/files/calibration/tofcalibTrigger_trTOF1_dec2011.txt"
#TOF_Trigger_calibration_file = "/files/calibration/tofcalibTrigger_trTOF0.txt"
# the date for which we want the cabling and calibration# date can be 'current' or a date in YYYY-MM-DD
#TOF_calib_date_from = 'current' TOF_calib_date_from = '2010-08-10 00:00:00'
```

Table 9.3: TOFSpacePoint class members.

| Name | Meaning |
|----------------|---|
| pixel_key | string encoded with the TOF station,plane,slab |
| slabY | int encoded with the TOF station,plane,slab |
| slabX | int encoded with the TOF station,plane,slab |
| time | double – calibrated space point time |
| charge | int – average of the charges of the constituent slabs |
| charge_product | int – average of charge products of the constituent slabs |
| dt | double – time difference between the x and y slabs = resolution |

Table 9.4: Data cards for TOF reconstruction.

| Name | Meaning | Default |
|--------------------------------|--------------------------------------|-----------|
| TOF_trigger_station | conversion | 0.005 MeV |
| TOF_findTriggerPixelCut | resolution for smearing the PMT time | 0.1 ns |
| TOF_makeSpacePiontCut | PMT collection efficiency | 0.25 |
| Enable_t0_correction | light attenuation in slabs | 1400 mm |
| Enable_triggerDelay_correction | conversion from charge to ADC | 0.125 |
| Enable_timeWalk_correction | conversion from time to TDC | 0.025 |

Table 9.5: Data cards for accessing calibrations from CDB.

| Name | Meaning | Default |
|-----------------------|------------|-----------------------|
| TOF_calib_date_from | conversion | '2010-08-10 00:00:00' |
| TOF_cabling_date_from | conversion | current |

```
TOF_cabling_date_from = 'current' Enable_timeWalk_correction = True  
Enable_triggerDelay_correction = True Enable_t0_correction = True
```

9.3 Database

- Constants in the CDB
- Datacards
- Routines to access

Chapter 10

The Trackers

10.1 Introduction

10.1.1 Overview

This chapter describes the software used to simulate and reconstruct the MICE scintillating fibre trackers. Section 10.2, 10.3 and 10.4 are reference sections providing descriptions of the official definitions, reference surfaces and coordinate systems, and reconstruction algorithms respectively. The later sections provide descriptions of the code as implemented in MAUS. A quick start guide regular users appears in below in section 10.1.2.

10.1.2 Quick start guide

Example scripts and datacards for the tracker reconstruction can be found in the `bin/user/scifi` directory. A typical top level python file to run a simulation with tracker reconstruction is shown below.

```
import io # generic python library for I/O
import gzip # For compressed output # pylint: disable=W0611
import MAUS

def run():
    # This input generates empty spills ,
    # to be filled by the beam maker later
    my_input = MAUS.InputPySpillGenerator()

    # The mappers for to set up the simulation
    my_map = MAUS.MapPyGroup()
    my_map.append(MAUS.MapPyBeamMaker()) # beam construction
    my_map.append(MAUS.MapCppSimulation()) # geant4 sim

    # The mappers for tracker MC digitisation and recon
    my_map.append(MAUS.MapCppTrackerMCDigitization())
    my_map.append(MAUS.MapCppTrackerRecon())

    # Specify config parameters via a datacard
    datacards = io.StringIO(u"")

    # The Pattern Recognition reducer to display tracks
    reducer = MAUS.ReduceCppPatternRecognition()

    # Output to ROOT file
```

```

my_output = MAUS.OutputCppRoot()

# The Go() drives all the components you pass in
MAUS.Go(my_input, my_map, reducer, my_output, datacards)

if __name__ == '__main__':
    run()

```

Listing 10.1: Example SciFi python script

Some important datacard parameters to consider when using the tracker software are:

- `SciFiPRHelicalOn` - set to True or False for helical pattern recognition
- `SciFiPRStraightOn` - set to True or False for straight pattern recognition
- `SciFiKalmanOn` - set to True or False for running the final track fit

10.2 Definitions

10.2.1 Labelling of upstream and downstream trackers

The official labels for the two trackers are:

Upstream tracker → Tracker#1
 Downstream tracker → Tracker#2

The internals of the code however will frequently refer to the upstream tracker as 0, and the downstream tracker as 1. In this document, we will use the official convention.

10.2.2 Station numbering

The tracker reference document defines the station “labelling” of the stations in relation to the focus-coil module that is immediately downstream of tracker 1 or, equivalently, immediately upstream of tracker 2. The station closest to the focus-coil module in question is labelled “1”. The label then increases such that station 5 is the station closest to the optical patch panel. The scheme is summarised in table 10.1 and figure 10.1.

Table 10.1: Station numbering scheme. The “label” of the stations that make up a MICE tracker runs from 1 to 5. The location of the station in relation to the patch panel and the absorber is reported in the column labelled “Location”.

| Location | Label |
|---|-------|
| Closest to absorber (furthest from patch panel) | 1 |
| | 2 |
| | 3 |
| | 4 |
| Furthest from absorber (closest to patch panel) | 5 |

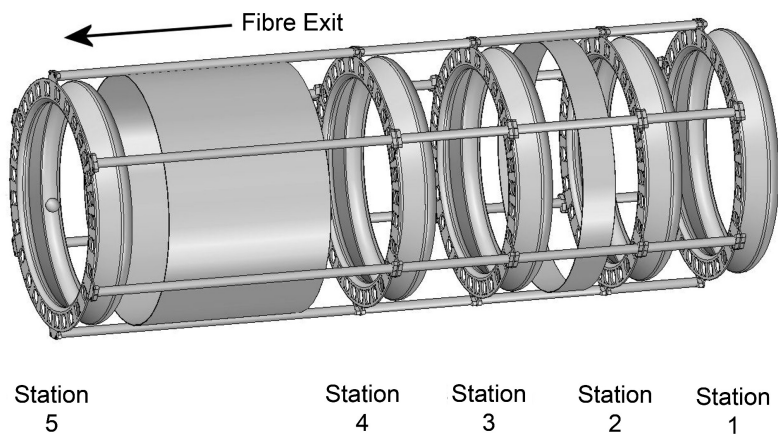

Figure 10.1: Schematic diagram of the MICE tracker. The five stations are shown supported by the carbon-fibre space frame, with fibres omitted for clarity. The station numbering scheme is indicated together with the direction in which the clear-fibre light-guides leave the tracking volume.

10.2.3 Doublet layer

Each station consists of three “doublet layers” of $350\ \mu\text{m}$ scintillating fibres glued onto a carbon-fibre station body. The doublet layers are labelled u (sometimes referred to also as x), w and v . The layers are arranged such that the fibres in one layer run at an angle of 120° to the fibres in each of the other layers as shown in figure 10.2a. The arrangement of the fibres within a doublet layer is shown in figure 10.2b. The configuration of the seven fibres ganged for readout via a single clear-fibre light-guide is also indicated.

Doublet-layer numbering

The order in which the doublet layers were glued onto the station body is shown in figure 10.3. The u layer was glued to the station body first. The doublet layer was glued such that the “fibre side” of the doublet layer was glued to the station body; i.e. the mylar sheet faces away from the station body. The w layer was then glued onto the outer surface of the u layer. The fibre side of the w layer was glued to the mylar sheet of the u layer such that the mylar sheet of the w layer also faces away from the station body. Finally, the v layer was glued onto the assembly. The gluing arrangement was the same as for the u and w layers, i.e. the mylar sheet of the v layer also faces away from the station body.

10.2.4 Fibre-channel numbering

The numbering of the groups of seven fibres ganged for readout is shown in figure 10.4. With the mylar surface facing up, and with the tails leading out to the station connectors taken to be at the bottom of the figure, the fibre-channel increases from left to right. The coordinate measured by the doublet layer (u , v or w) is taken to increase in the same direction as the channel number. The origin of the measured coordinate is taken to be at the position of the central fibre.

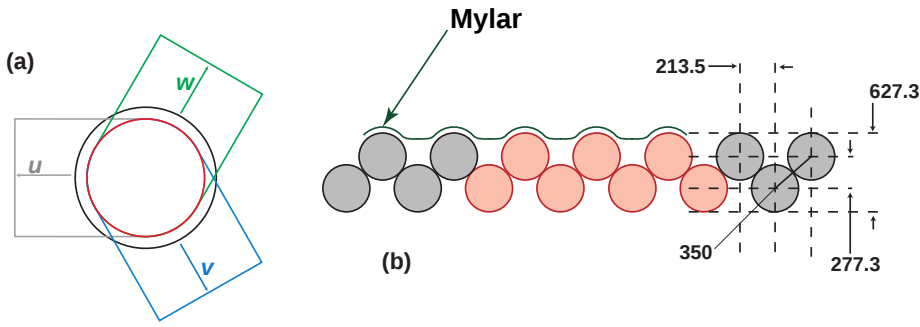

Figure 10.2: (a) Arrangement of the doublet layers in the scintillating-fibre stations. The outer circle shows the solenoid bore while the inner circle shows the limit of the active area of the tracker. The grey, blue, and green regions indicate the direction that the individual $350\ \mu\text{m}$ fibres run (moving outward from the centre) in the u , v , and w planes respectively. (b) Detail of the arrangement of the scintillating fibres in a doublet layer. The fibre spacing and the fibre pitch are indicated on the right-hand end of the figure in μm . The pattern of seven fibres ganged for readout in a single clear-fibre light-guide is shown in red. The sheet of Mylar glued to the doublet layer is indicated.

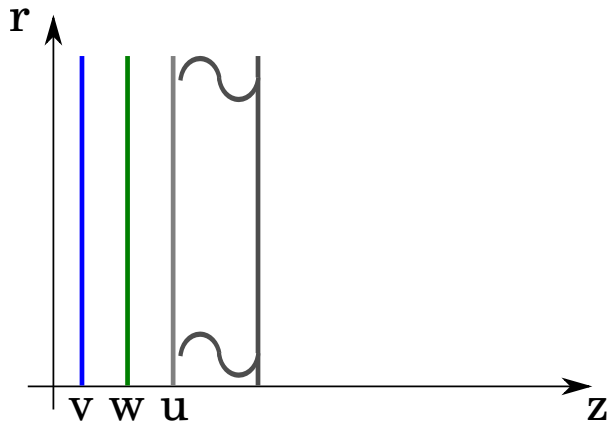
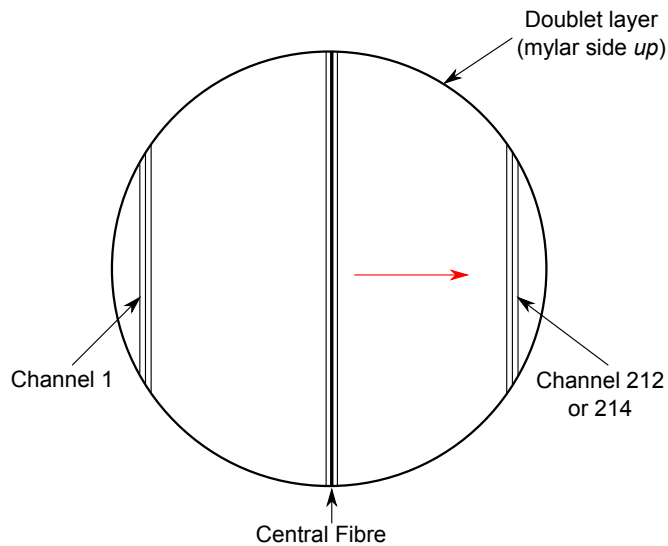

Figure 10.3: The order in which the doublet layers were glued onto the station body. The station body is indicated by the solid black lines. The u layer (shown as the grey line) was glued to the station body first. The w (indicated by the green line) was then glued onto the outer surface of the u layer. The outer doublet layer, the v layer (shown as the blue line) was then glued onto the assembly. The station reference surface and the direction of increasing z are shown as the thin black lines.



Fibre run to the station optical connectors taken to be towards the bottom of the figure

Figure 10.4: The order in which fibre channels (groups of seven fibres) are numbered. The sensitive surface of the doublet layer is indicated by the solid circle. The direction in which the fibres run is indicated by the vertical lines. The station optical connectors are taken to be at the bottom of the figure as indicated. With the mylar sheet taken to be facing up, fibre-channel number 1 is to the left of the central fibre. The fibre-channel number increases from left to right. The “zero” of the coordinate (u , v or w increases) measured by the doublet layer is taken to be the position of the central fibre. The direction in which the coordinate measured by the double layer increases is indicated by the red arrow.

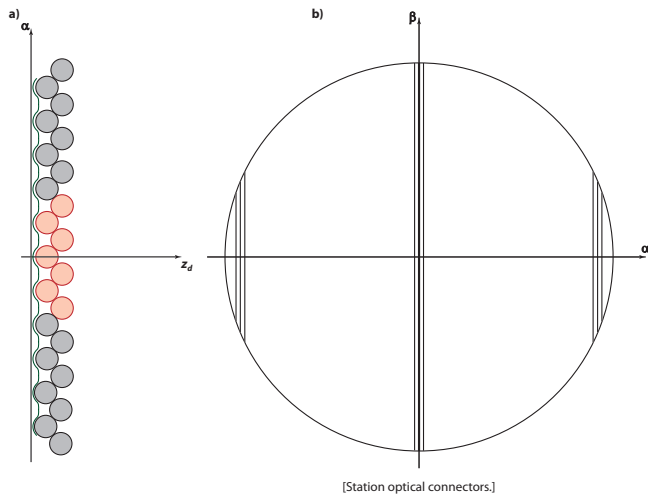

Figure 10.5: Reference surfaces and coordinate-system definitions for the double layer and station. a) The fibres in the doublet layer are shown as the shaded circles, the central channel being shaded pink. The mylar layer is indicated by the solid black corrugated line. The doublet-layer reference surface is indicated by the vertical straight line, the arrow labelled α indicates the direction in which the coordinate measured by the doublet layer (u , v or w) increases. The direction of the z_d axis is indicated. b) View of doublet layer looking down on the mylar layer with the optical connectors at the bottom of the figure. The coordinate measured by the doublet layer (u , v or w) is indicated by the axis labelled α . The orthogonal axis, i.e. the direction in which the fibres run, is labelled β . The origin of the (α, β) coordinate system is taken to be at the centre of the circular active area.

10.3 Reference surfaces and coordinate systems

10.3.1 Doublet layer

The doublet-layer reference surface is defined to be the flat plane that is tangential to the outer surface of the mylar plane as shown in Figure 10.5a. The measured coordinate, $\alpha \in u, v, w$, is defined to lie in this plane and the α axis is perpendicular to the direction in which the fibres run. The doublet-layer z_d axis is defined to be perpendicular to the doublet-layer reference surface increasing in the direction indicated in the figure. The direction in which the measured coordinate, α increases is indicated in figure 10.5b. The orthogonal coordinate in the doublet-layer reference surface that with α and z_d completes a right handed coordinate system is referred to as β . The β axis is also indicated in figure 10.5b.

10.3.2 Station

The station reference surface is defined to coincide with the reference surface of the v doublet layer (see figure 10.6). The station coordinate system is defined such that the y_s axis is coincident with v axis, the z_s axis is coincident with the z_d axis of the v layer and the x_s axis completes a right-handed coordinate system.

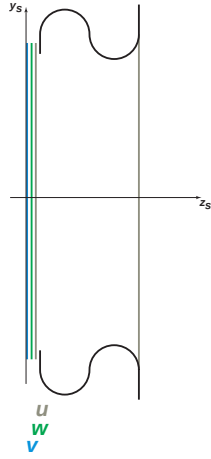

Figure 10.6: The carbon-fibre station body is indicated by the heavy solid black lines. The three doublet layers are indicated by the solid grey (u), green (w) and blue (v) lines. The station reference surface is shown by the solid vertical line coincident with the reference surface of the doublet layer labelled v . The direction y_s axis, defined to be coincident with the v axis and the z_s axes are shown as the solid, black arrows. The x_s axis completes a right-handed coordinate system and therefore points into the page.

10.3.3 Tracker

The tracker reference surface is defined to coincide with the reference surface of station 1. The tracker coordinate system is defined such that the z_t axis coincides with the nominal axis of cylindrical symmetry of the tracker as shown in figure 10.7. The tracker z_t coordinate increases from station 1 to station 5. The tracker y_t axis is defined to coincide with the y_s axis of station 1 and the tracker x_t axis completes a right-handed coordinate system.

10.3.4 Coordinate transformations

Doublet-layer to station

The transformation from doublet-layer to station coordinates is achieved using the rotation $\underline{\underline{R}}_{SD}$ defined by:

$$\mathbf{r}_s = \begin{pmatrix} x_s \\ y_s \end{pmatrix} = \underline{\underline{R}}_{SD} \mathbf{m} = \begin{pmatrix} \cos \theta_D & -\sin \theta_D \\ \sin \theta_D & -\cos \theta_D \end{pmatrix} \begin{pmatrix} \alpha \\ \beta \end{pmatrix}; \quad (10.1)$$

where θ_D is the angle which the fibres that make up the doublet-layer make to the x_s axis in the station coordinate system.

10.4 Reconstruction Algorithms

10.4.1 Hits and clusters

A track passing through a particular doublet layer produces scintillation light in one or at most two fibre channels. For each channel “hit”, the tracker data acquisition system records the channel number, n , and the pulse height. After calibration, the pulse height is recorded in terms of the number of photo-electrons

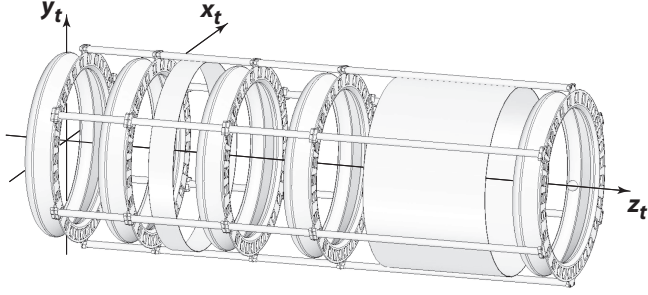

Figure 10.7: The outline of the components that make up the MICE tracker are shown in the line drawing. The tracker reference surface coincides with the reference surface of station 1. The tracker coordinate system is indicated by the solid lines. The y_t axis is defined to be coincident with the y_s axis in the station coordinate system. The z_t axis runs along the nominal axis of the tracker. The x_t axis completes a right-handed coordinate system.

(n_{pe}) generated in the Visible Light Photon Counter (VLPC) illuminated by the hit channel. Occasionally, showers of particles or noise can cause three or more neighbouring channels to be hit. The term “clusters” is used to refer to an isolated hit, a doublet cluster and a multi-hit cluster.

The position of a hit in the doublet-layer coordinate system may be determined from the channel number. For isolated hits, the measured coordinate $\alpha \in u, v, w$ is given by:

$$\alpha = c_p(n - n_0); \quad (10.2)$$

where n_0 is the channel number of the central fibre and c_p is the channel pitch given by:

$$c_p = 3f_p + f_d \quad (10.3)$$

where f_d is the fibre diameter ($f_d = 350 \mu\text{m}$) and f_p is the fibre pitch ($f_p = 427 \mu\text{m}$ see figure 10.2). For clusters in which two channels are hit (“doublet clusters”, see figure 10.8), the measured coordinate is given by:

$$\alpha = c_p \left[\frac{(n_1 + n_2)}{2} - n_0 \right]; \quad (10.4)$$

where n_1 and n_2 are the channel numbers of the two hit fibres. For a multi-hit cluster (clusters with more than two neighbouring channels), the measured position is determined from the pulse-height weighted mean of the fibre positions:

$$\alpha = c_p \left[\frac{\sum_i n_{pei} n_i}{\sum_i n_{pei}} \right]; \quad (10.5)$$

where the subscript i indicates the i^{th} channel. The pulse-height for doublet and multi-channel clusters is determined by summing the pulse height of all the hits that make up the cluster.

The “measurement vector”, \mathbf{m} is defined as:

$$\mathbf{m} = \begin{pmatrix} \alpha \\ \beta \end{pmatrix}; \quad (10.6)$$

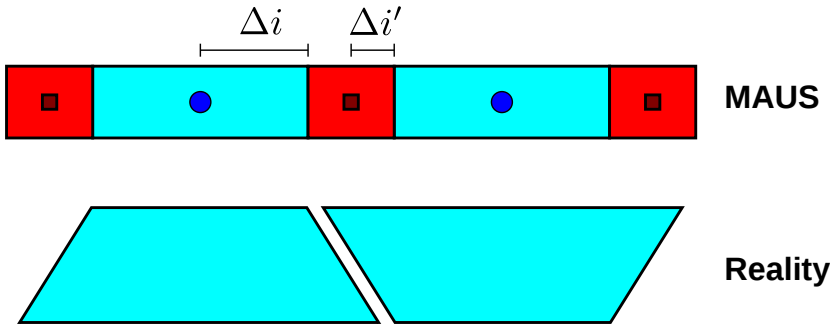

Figure 10.8: Channel overlap as simulated in MAUS; fine-tuning reduces the error associated to doublet clusters.

where α is given above and, in the absence of additional information, $\beta = 0$. The corresponding covariance matrix is given by:

$$\underline{V}_m = \begin{pmatrix} \sigma_\alpha^2 & 0 \\ 0 & \sigma_\beta^2 \end{pmatrix}; \quad (10.7)$$

where σ_α^2 and σ_β^2 are the variance of α and β respectively. The variance on α for a single-hit cluster is given by:

$$\sigma_m^2 = \frac{c_p^2}{12}. \quad (10.8)$$

For a doublet-cluster, the variance is given by:

$$\sigma_m^2 = \frac{\Delta_\alpha^2}{12}; \quad (10.9)$$

where Δ_α is the length of the overlap region between neighbouring fibre channels (see figure 10.8). For multi-hit clusters, the variance is given by:

$$\sigma_m^2 = \frac{??}{??}. \quad (10.10)$$

The variance of the perpendicular coordinate, β , depends on the effective length, l_{eff} of the fibre (see figure ?? and Appendix ??) and is given by:

$$\sigma_\beta^2 = \frac{l_{\text{eff}}^2}{12}; \quad (10.11)$$

where:

$$l_{\text{eff}} = ?? . \quad (10.12)$$

10.4.2 Space-point reconstruction

This section describes the space-point reconstruction, the algebra by which the cluster positions are translated in to tracker coordinates and, to some extent, the algorithm.

Selection of clusters that form the space-point

For each particle event, the clusters found within each doublet layer are ordered by fibre-channel number. Taking each station in turn, an attempt is made to

generate a space point using all possible combinations of clusters. The three clusters, one each from views u , v and w , that make up a space point satisfy:

$$n^u + n^v + n^w = n_0^u + n_0^v + n_0^w; \quad (10.13)$$

where n^u , n^v and n^w are the fibre numbers of the clusters in the u , v and w views respectively and n_0^u , n_0^v and n_0^w are the respective central-fibre numbers (see Appendix 14.1).

A triplet space point is selected if:

$$|(n^u + n^v + n^w) - (n_0^u + n_0^v + n_0^w)| < K. \quad (10.14)$$

Once all triplet space-points have been found, doublet space-points are created from pairs of clusters from different views.

Crossing-position calculation

Doublet space-points The position of the doublet space-point in station coordinates, \mathbf{r}_s , is given by:

$$\mathbf{r}_s = \begin{pmatrix} x_s \\ y_s \end{pmatrix} \quad (10.15)$$

$$= \underline{\underline{R}}_{SD1} \mathbf{m}_1 \quad (10.16)$$

$$= \underline{\underline{R}}_{SD2} \mathbf{m}_2; \quad (10.17)$$

where the measurement vector corresponding to the i^{th} cluster:

$$\mathbf{m}_i = \begin{pmatrix} \alpha_i \\ \beta_i \end{pmatrix}; \quad (10.18)$$

and the rotation matrix $\underline{\underline{R}}_{SDi}$ are defined in section 10.4.1. The simultaneous equations 10.16 and 10.17 contain two unknowns, β_1 and β_2 . Equations 10.16 and 10.17 may be rewritten:

$$\mathbf{m}_1 = \underline{\underline{R}}_{SD1}^{-1} \underline{\underline{R}}_{SD2} \mathbf{m}_2. \quad (10.19)$$

Defining:

$$\underline{\underline{S}} = \underline{\underline{R}}_{SD1}^{-1} \underline{\underline{R}}_{SD2} \quad (10.20)$$

$$= \begin{pmatrix} s_{11} & s_{12} \\ s_{21} & s_{22} \end{pmatrix}; \quad (10.21)$$

Equations 10.16 and 10.17 may be solved to yield:

$$\beta_2 = \frac{\alpha_1 - s_{11}\alpha_2}{s_{12}} \quad (10.22)$$

$$\beta_1 = s_{21}\alpha_2 + s_{22}\beta_2. \quad (10.23)$$

The position of the space-point may now be obtained from equation 10.16 or 10.17.

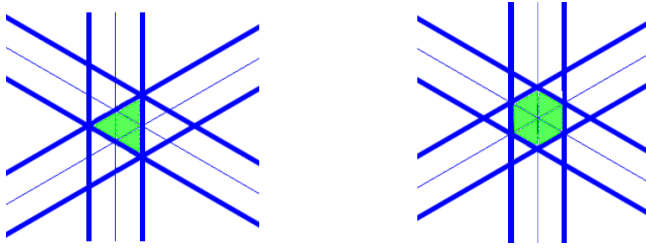

Figure 10.9: Right panel: Fibre arrangement in station 5 of tracker 1. Left panel: Fibre arrangement in the rest of the stations. The shaded region shows the intersection of the three channels is triangle for every station other than station 5, where it will be an hexagon.

Triplet space-points As shown in figure 10.9, the fibres layout is of one of two types. In one case (right panel of figure 10.9), the centre of the channels, one in each of the three views, cross intersect at a single point. In this case, the position of the crossing can be calculated as described in section 10.4.2. When the area of overlap of the three channels forms a triangle (figure 10.9 left panel), the centre of area of overlap is given by:

$$\bar{x} = \frac{2}{3}c_p; \text{ and} \quad (10.24)$$

$$\bar{y} = 0. \quad (10.25)$$

10.4.3 Pattern recognition

Straight-line pattern recognition

In the absence of a magnetic field, the tracks passing through the tracker may be described using a straight line in three dimensions. Taking the z coordinate as the independent parameter, the track parameters may be taken to be:

$$\mathbf{v}^{\text{sl}} = \begin{pmatrix} x_0 \\ y_0 \\ t_x \\ t_y \end{pmatrix}; \quad (10.26)$$

where, x_0 and y_0 are the position at which the track crosses the tracker reference surface, $t_x = \frac{dx}{dz}$ and $t_y = \frac{dy}{dz}$. The track model may then be written:

$$x = x_0 + zt_x; \text{ and} \quad (10.27)$$

$$y = y_0 + zt_y. \quad (10.28)$$

Pattern recognition then proceeds as follows. A space-point is chosen in each of two stations, i and j where i and j label two different stations and $j > i$. Ideally, $i = 1$ and $j = 5$. However, a search of all combinations of pairs for which $j - i > 1$ is made, taking the pairs in the order of decreasing separation in z ; i.e. in order of decreasing $\Delta z_{ji} = z_j - z_i$. Initial values for the track parameters,

$$\mathbf{v}_{\text{Init}}^{\text{sl}} = \begin{pmatrix} x_0^{\text{Init}} \\ y_0^{\text{Init}} \\ t_x^{\text{Init}} \\ t_y^{\text{Init}} \end{pmatrix}, \quad (10.29)$$

are then calculated as follows:

$$t_x^{\text{Init}} = \frac{x_j - x_i}{z_j - z_i}; \quad (10.30)$$

$$x_0^{\text{Init}} = x_i - z_i t_x^{\text{Init}}; \quad (10.31)$$

$$t_y^{\text{Init}} = \frac{y_j - y_i}{z_j - z_i}; \text{ and} \quad (10.32)$$

$$y_0^{\text{Init}} = y_i - z_i t_y^{\text{Init}}; \quad (10.33)$$

where (x_i, y_i, z_i) are the coordinates of space-point i , etc. A search is then made for space-points in each of the stations, k , between station i and station j . The distance between the x and y coordinates of the space-points in the stations k ; $j < k < i$ and the line defined by the initial track parameters is then calculated at the reference surface of station k as follows:

$$\delta x_k = x_k - (x_0^{\text{Init}} + z_k t_x^{\text{Init}}) \text{ and} \quad (10.34)$$

$$\delta y_k = y_k - (y_0^{\text{Init}} + z_k t_y^{\text{Init}}). \quad (10.35)$$

Points are accepted as part of a “trial” track if:

$$|\delta x_k| < \Delta_x \text{ and} \quad (10.36)$$

$$|\delta y_k| < \Delta_y. \quad (10.37)$$

If at least one space-point satisfies this selection, a “trial track” is formed consisting of the space-points selected in stations i, k, \dots and j . For each “trial track”, a straight-line fit is performed to calculate the fit χ^2 :

$$\chi^2 = \chi_x^2 + \chi_y^2. \quad (10.38)$$

If the fit χ^2 satisfies:

$$\frac{\chi^2}{N-2} < \chi_{\text{cut}}^2, \quad (10.39)$$

then the trial track is accepted.

Helix pattern recognition

Helix parameters In the presence of a magnetic field, the tracks passing through the tracker may be described using a helix. In tracker coordinates, the tracks form circles in the (x, y) plane. Defining s to be the length of the arc swept out by the track in the (x, y) plane, a track may be described using a straight line in the (s, z) plane. Taking the z coordinate as the independent parameter, the track parameters may be taken to be:

$$\mathbf{v}^{\text{hlx}} = \begin{pmatrix} x_0 \\ y_0 \\ \psi_0 \\ t_s \\ \rho \end{pmatrix}; \quad (10.40)$$

where, x_0 and y_0 are the position at which the track crosses the tracker reference surface, ψ_0 is the azimuthal angle of the line tangent to the track in the (x, y)

plane, $t_s = \frac{ds}{dz}$ and ρ is the radius of curvature. The angle ψ_0 is chosen such that:

$$\hat{\psi}_0 = \hat{\mathbf{k}} \times \hat{\mathbf{r}}; \quad (10.41)$$

where $\hat{\mathbf{r}}$ is the unit vector in the direction (x_0, y_0) and $\hat{\mathbf{k}}$ is the unit vector parallel to the z axis. $\hat{\psi}_0$ is the unit vector tangent to the track and in the direction is defined by ψ_0 . With this definition, the projection on the (x, y) plane of a positive track propagating in the positive z direction sweeps anticlockwise.

Track model for pattern recognition To build up the track model, consider a track-based coordinate system which has its origin at the point (x_0, y_0) and in which the x' axis is parallel to the line joining (x_0, y_0) to the centre of the circle described by the track, the y' axis is parallel to $\hat{\psi}_0$ and the z' axis is parallel to $\hat{\mathbf{k}}$ (see figure 10.10).

A point, i , on the track at (x_i, y_i) (tracker coordinates) at which the track direction is ψ_i may be used to write down the track model as:

$$x'_i = \rho[\cos \phi'_i - 1] \text{ and} \quad (10.42)$$

$$y'_i = \rho \sin \phi'_i; \quad (10.43)$$

where:

$$\tan \frac{\phi'_i}{2} = \frac{\sqrt{(x_i - x_0)^2 + (y_i - y_0)^2}}{2\rho}. \quad (10.44)$$

The z coordinate is taken as a parameter since the construction of the trackers ensures that each reference surface (tracker, station or doublet layer) is at a well defined z . The distance travelled in the (x, y) plane to reach the i^{th} point, s_i , is related to the z coordinate of the i^{th} point by:

$$s_i = t_s z_i; \quad (10.45)$$

since the track is referred to the tracker reference surface. The transformation from the primed to tracker coordinates is achieved with a rotation, $\underline{\underline{R}}'$, through an angle $-\beta$ and a translation, $\underline{\underline{T}}'$ from (x_0, y_0) to $(0, 0)$:

$$\begin{pmatrix} x \\ y \end{pmatrix} = \underline{\underline{T}}' + \underline{\underline{R}}' \begin{pmatrix} x' \\ y' \end{pmatrix}. \quad (10.46)$$

These transformations are given by:

$$\underline{\underline{R}}' = \begin{pmatrix} \cos \beta & -\sin \beta \\ \sin \beta & \cos \beta \end{pmatrix}; \text{ and} \quad (10.47)$$

$$\underline{\underline{T}}' = \begin{pmatrix} -x_0 \\ -y_0 \end{pmatrix}; \quad (10.48)$$

$$(10.49)$$

where:

$$\beta = \psi_0 - \frac{\pi}{2}. \quad (10.50)$$

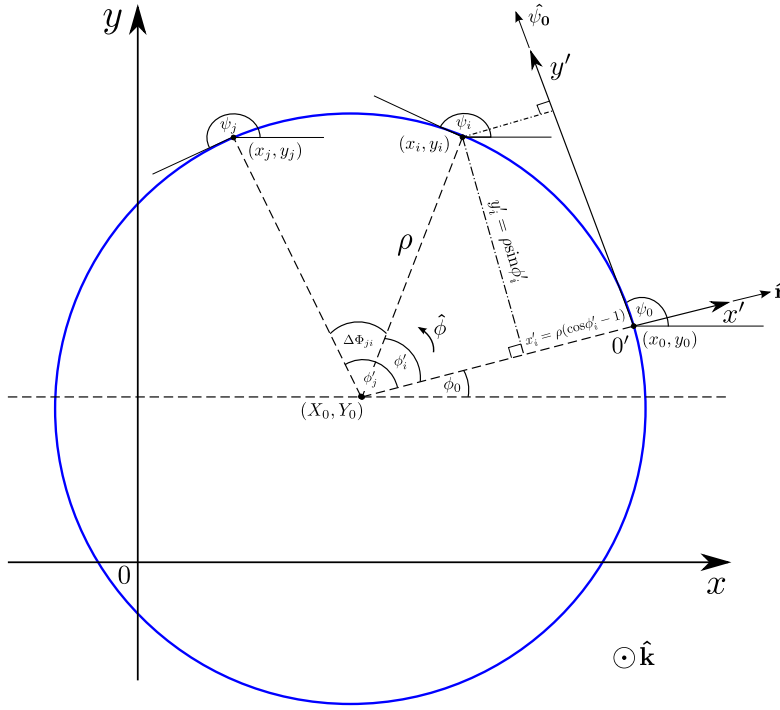

Figure 10.10: Schematic diagram of track in (x, y) plane.

Collecting space-points in the (x, y) plane Helix pattern recognition follows the same conceptual steps as the straight-line pattern recognition described in section 10.4.3 A space-point is chosen in each of three stations, i, j and k where $k > j > i$. Ideally, $i = 1, j = 3$ and $k = 5$. However, a search of all combinations of three space-points for which $k - j > 0$ and $j - i > 0$ is made, taking the combinations in the order of decreasing separation in z ; i.e. in order of decreasing $\Delta z_{kj} = z_k - z_j$ and $\Delta z_{ji} = z_j - z_i$.

A circle in the (x, y) plane may be written (see Appendix 14.3):

$$\alpha(x^2 + y^2) + \beta x + \gamma y + \kappa = 0; \quad (10.51)$$

where:

$$X_0 = \frac{-\beta}{2\alpha}; \quad (10.52)$$

$$Y_0 = \frac{-\gamma}{2\alpha}; \quad (10.53)$$

$$\rho = \sqrt{\frac{\beta^2 + \gamma^2}{4\alpha^2} - \frac{\kappa}{\alpha}}; \quad (10.54)$$

and (X_0, Y_0) are the coordinates of the centre of the circle. Initial values for α, β, γ and κ are obtained as described in Appendix 14.3. The distance between the x and y coordinates of the space-points in the stations $l; l \neq i, j, k$ and the circle defined by equation 10.51 is given by:

$$\delta = \sqrt{(x_l - X_0)^2 + (y_l - Y_0)^2} - \rho. \quad (10.55)$$

In terms of the parameters α , β , γ and κ , δ may be written:

$$\delta = \sqrt{(x_l^2 + y_l^2) + \frac{\beta^2 + \gamma^2}{4\alpha^2} + \frac{\beta x_l + \gamma y_l}{\alpha}} - \sqrt{\frac{\beta^2 + \gamma^2}{4\alpha^2} - \frac{\kappa}{\alpha}}. \quad (10.56)$$

Points are accepted as part of a “trial” track if:

$$|\delta| < \Delta_C. \quad (10.57)$$

If at least one space-point satisfies this selection, a “trial track” is formed consisting of the space-points selected in stations i , j , k , ... and l .

For each “trial track”, a circle fit is performed to calculate the fit χ_C^2 . If χ_C^2 satisfies:

$$\frac{\chi^2}{N-3} < \chi_{C \text{ cut}}^2, \quad (10.58)$$

then the trial track is accepted.

Collecting space-points in the (s, z) plane The set of space points which make up the trial track provide a set of (s, z) coordinates which should lie on a straight line. Equation 10.45 implies:

$$s_i = \rho(\phi'_i - \phi'_0) = t_s z_i. \quad (10.59)$$

The angles turned through as the track propagates from station i to station j ($\Delta\Phi_{ji}$), from station j to station k ($\Delta\Phi_{kj}$) and from station i to station k are then given by:

$$\Delta\Phi_{ji} = \phi'_j - \phi'_i; \quad (10.60)$$

$$\Delta\Phi_{kj} = \phi'_k - \phi'_j; \text{ and} \quad (10.61)$$

$$\Delta\Phi_{ki} = \phi'_k - \phi'_i. \quad (10.62)$$

The definition of the tracker coordinate system ensures that:

$$\frac{\Delta\Phi_{ji} + 2n\pi}{\Delta z_{ji}} = \frac{\Delta\Phi_{kj} + 2m\pi}{\Delta z_{kj}} = \frac{\Delta\Phi_{ki} + 2(n+m)\pi}{\Delta z_{ki}}. \quad (10.63)$$

Defining:

$$\eta_{ji} = \frac{\Delta\Phi_{ji}}{\Delta z_{ji}}; \quad (10.64)$$

$$\eta_{kj} = \frac{\Delta\Phi_{kj}}{\Delta z_{kj}}; \text{ and} \quad (10.65)$$

$$\eta_{ki} = \frac{\Delta\Phi_{ki}}{\Delta z_{ki}}; \quad (10.66)$$

Equations 10.63 may be inverted to yield:

$$m = \frac{\Delta z_{kj}}{2\pi} [\eta_{ji} - \eta_{kj}] + \frac{\Delta z_{kj}}{\Delta z_{ji}} n. \quad (10.67)$$

The correct values for n and m may now be obtained by calculating:

$$\Lambda = \eta_{ji} - \eta_{kj}; \text{ and} \quad (10.68)$$

$$\Gamma = \frac{2\pi}{\Delta z_{ji}} \left[m - \frac{\Delta z_{ki}}{\Delta z_{ji}} n \right]. \quad (10.69)$$

The most likely values of n and m for the cases of interest are $n = 0$ and $m = 0$. Therefore, searching for values of n and m for which:

$$|\Lambda - \Gamma| < \Delta_{sz}; \quad (10.70)$$

will yield the change in ϕ' that corresponds to a step in z .

The final step in gathering the points in (s, z) is to perform a straight line fit to the set of points corrected for multiple turns between stations. If the track fit χ_{sz}^2 satisfies:

$$\chi_{sz}^2 < \chi_{szC}^2; \quad (10.71)$$

then an attempt is made to fit a helix to the set of space points that make up the track.

Helix fit At present, pattern recognition does not employ a full 3D helix fit, due to the complexity of performing a non-linear least squares fit. The following is for reference only.

The construction of the tracker allows the helical locus of the points on the track to be parameterised as a function of z . The step from station i to station j , a change in the z position of the track of $\Delta z_{ji} = z_j - z_i$, results in a change in ϕ' , and therefore s , where:

$$\Delta \Phi_{ji} = \frac{t_s \Delta z_{ji}}{\rho}; \text{ and} \quad (10.72)$$

$$\Delta s_{ji} = \rho \Delta \Phi_{ji} = \rho(\psi_j - \psi_i). \quad (10.73)$$

The coordinates of the track at the i^{th} station may now be written:

$$\mathbf{v}_i^{\text{hlx}} = \mathbf{v}^{\text{hlx}} + \Delta \mathbf{v}_i^{\text{hlx}}; \quad (10.74)$$

where:

$$\Delta \mathbf{v}_i^{\text{hlx}} = \begin{pmatrix} \Delta x_{i0} \\ \Delta y_{i0} \\ \Delta \Psi_{i0} \\ 0 \\ 0 \end{pmatrix}. \quad (10.75)$$

$\Delta \Psi_{i0} = \psi_i - \psi_0$ and Δx_{i0} and Δy_{i0} are obtained by evaluating:

$$\Delta x_{i0} = x_i - x_0; \text{ and} \quad (10.76)$$

$$\Delta y_{i0} = y_i - y_0 \quad (10.77)$$

where:

$$\mathbf{h}_i^{\text{hlx}} = \begin{pmatrix} x_i \\ y_i \end{pmatrix} = \underline{\underline{T}}' + \underline{\underline{R}}' \begin{pmatrix} x_i' \\ y_i' \end{pmatrix}; \quad (10.78)$$

and:

$$\overline{\phi}'_i = \overline{\phi}_0 + \Delta\Psi_{i0}. \quad (10.79)$$

The helix fit described in Appendix 14.4 proceeds by minimizing:

$$\chi_{\text{hlx}}^2 = \sum_i^N \left\{ [\mathbf{m}_i^{\text{sp}} - \mathbf{h}_i^{\text{hlx}}]^T \left[\underline{\underline{V}}_i^{\text{sp}} \right]^{-1} [\mathbf{m}_i^{\text{sp}} - \mathbf{h}_i^{\text{hlx}}] \right\}. \quad (10.80)$$

If the helix fit χ_{hlx}^2 satisfies:

$$\frac{\chi_{\text{hlx}}^2}{2N - 5} < \chi_{\text{hlxC}}^2; \quad (10.81)$$

then the trial track is accepted.

10.4.4 Track fit

10.5 Data structure

The tracker data structure, a subset of the general MAUS data structure, is shown in figure 10.11. The basic unit of the MAUS data structure is the spill, representing the data produced by a single actuation of the MICE target. All MAUS modules (mappers, reducers, etc.) act on one spill at a time. The spill is then split into two sides, Monte Carlo data and reconstructed data. A key rule is that MC data must never be stored on the reconstruction side. Each side has its own event class, representing data corresponding to a single MICE particle trigger event. The relationship between the spill and the MC and recon event objects is one-to-many.

Within an MC event the only data object pertaining to the tracker is the SciFiHit, implemented as template class of the generic Hit class. This class stores the MC data used by the reconstruction to form SciFiDigits (via the map MapCppTrackerMCDigitisation). The relationship between MC events and SciFiHits is one-to-many.

On the real data side each recon event holds a single SciFiEvent (a one-to-one relationship). The SciFiEvent then holds a collection (implemented as C++ standard vectors of pointers) for each data type used in the reconstruction process: SciFiDigits, SciFiClusters, SciFiSpacePoints, SciFiStraightPRTracks, SciFiHelicalPRTracks, SciFiStraightKalmanTracks, and SciFiTracks. Additionally SciFiTrackPoints are held by each SciFiTrack instance.

10.6 Code Design

10.6.1 General Code Structure

The main body of the tracker code is implemented as three distinct MAUS map modules and, at present, one reducer module. There also exist various helpful top-level user tools, and the tracker geometry, calibration and configuration files. A diagram showing the tracker software data flow with the corresponding modules is shown in figure 10.12, with the following sections expanding on each area.

MapCppTrackerDigits

This map is used to digitise real data. It calls on additional functionality from the RealDataDigitisation class, which is stored in `src/common_cpp/Recon/SciFi`.

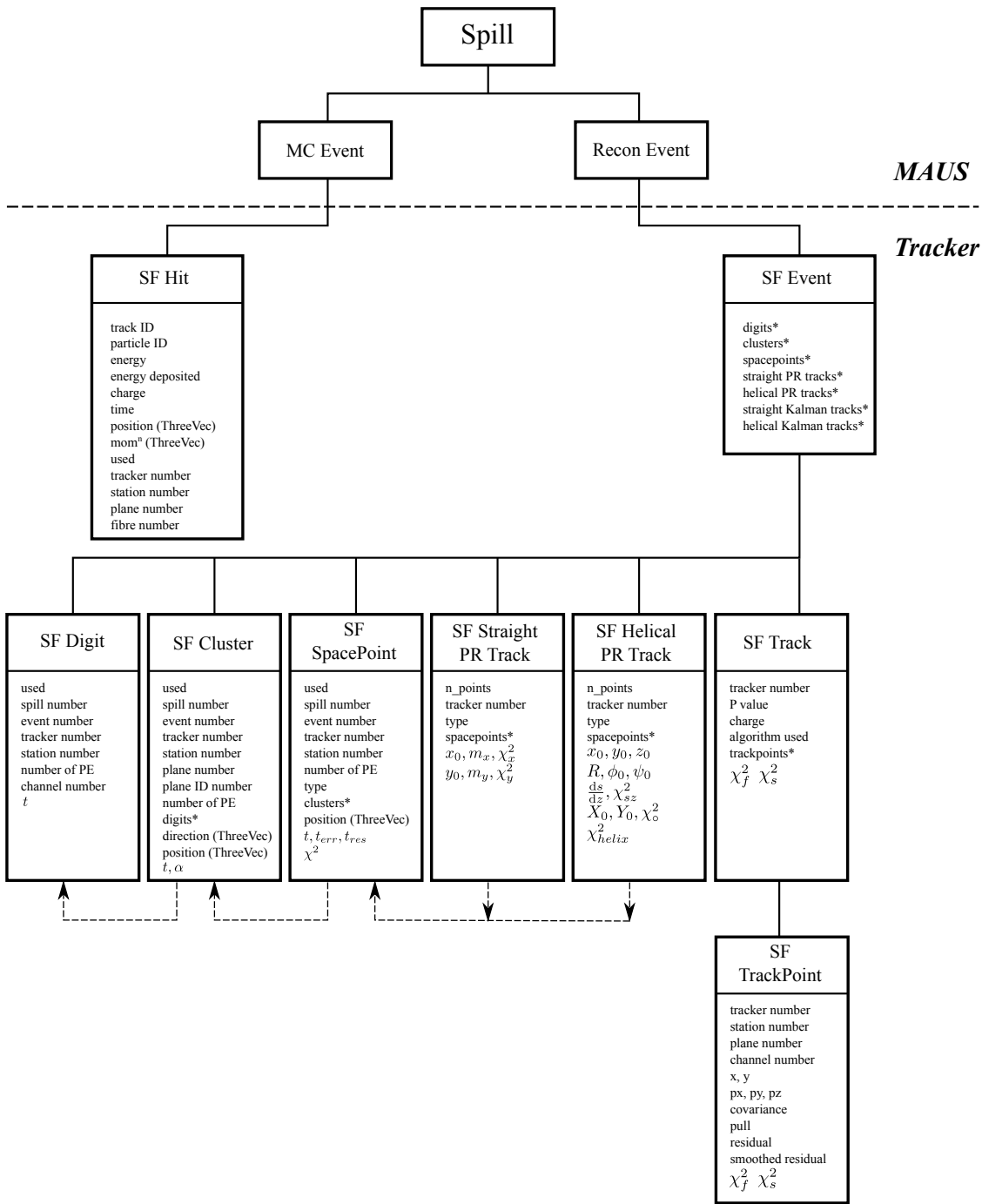

Figure 10.11: The tracker data structure and its position within the general MAUS data structure. An asterisk indicates a vector of pointers. The dotted lines indicate cross links realised as vectors of pointers.

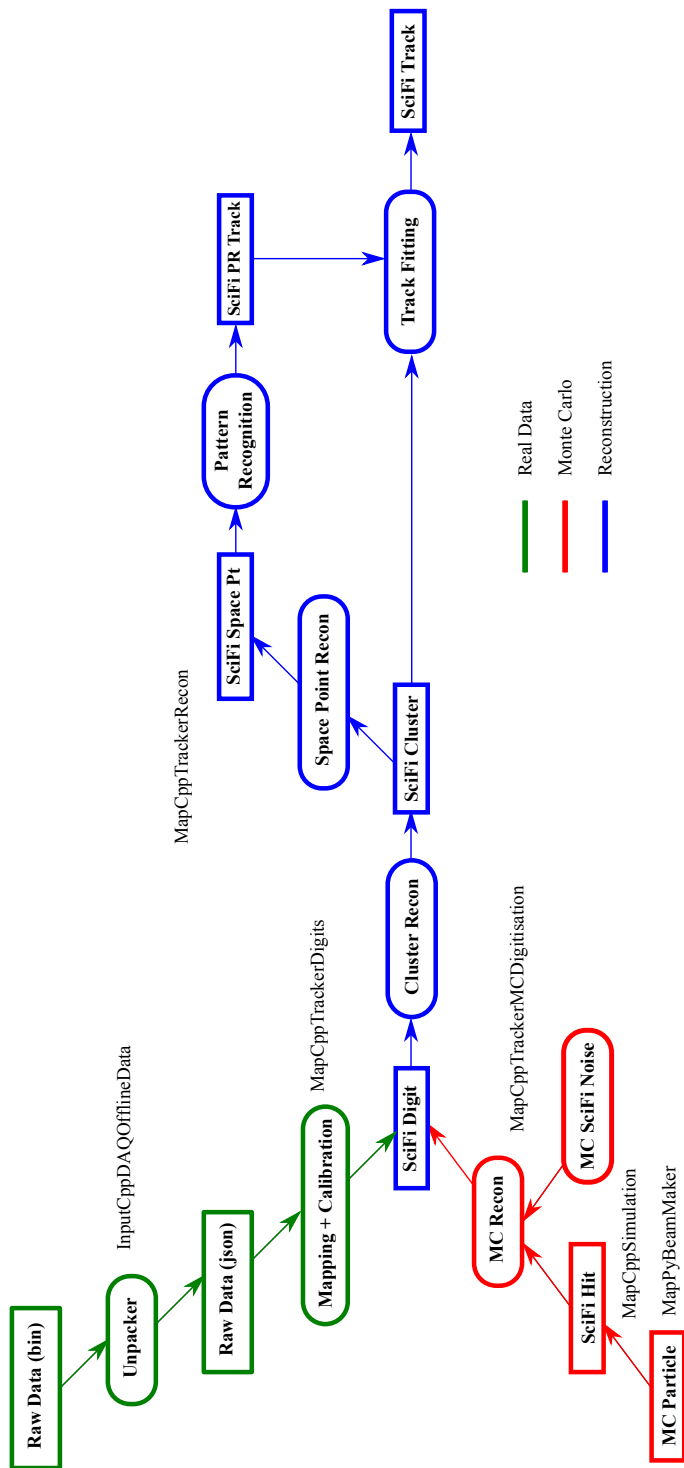

Figure 10.12: Schematic of the tracker software data showing MC and Real data input, and subsequent reconstruction. MAUS modules corresponding to given process are indicated (MapC++TrackerRecon encompasses all of the reconstruction, shown in blue). Once digits have been formed, reconstruction is agnostic as to whether the MC or Real path was followed.

MapCppTrackerMCDigitisation

This map is used to digitise Monte Carlo data.

MapCppTrackerRecon

This map performs the main reconstruction work, moving from digits to cluster to spacepoints to pattern recognition tracks, and finally full Kalman tracks. Most work is farmed out to backend C++ classes. The following are the top level classes for each stage of the reconstruction, and are stored in `src/common_cpp/Recon/SciFi`:

- SciFiClusterRecon - cluster reconstruction from digits
- SciFiSpacepointRecon - spacepoint reconstruction from cluster
- PatternRecognition - association of spacepoints to tracks, and crude initial track fit

The backend classes for the final track fit are stored under `src/common_cpp/Recon/Kalman` and `src/common_cpp/Recon/Bayes`, the top level class being `KalmanTrackFit`. Other classes used include:

- KalmanFilter
- KalmanHelicalPropagator
- KalmanStraightPropagator
- KalmanState
- KalmanSeed

ReduceCppPatternRecognition

This reducer displays spacepoints and pattern recognition tracks by tracker, in the $x - y$, $x - z$ and $y - z$ projections, an example being shown in figure 10.13. It also creates an InfoBox, which displays various information for the spill and run, such as the number of clusters, spacepoints, etc. The plots are made using ROOT TGraphs, and the InfoBox with a TPaveText.

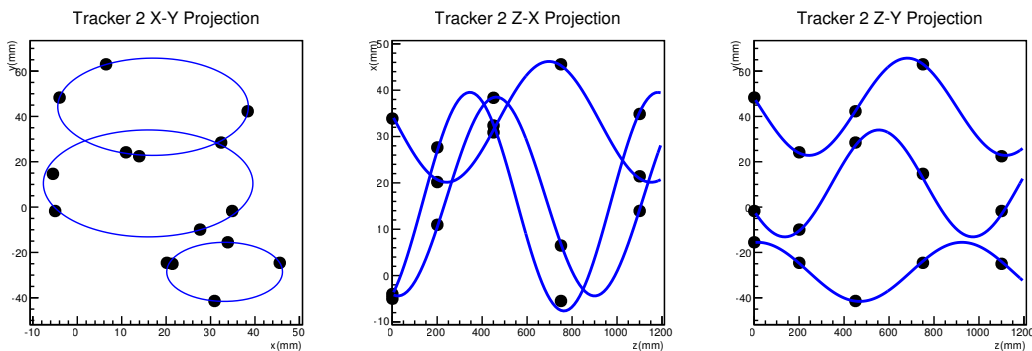

Figure 10.13: Output from the pattern recognition reducer showing the real space projections of a three event spill in tracker 2.

Reducer Backend

The backend classes for the reducers are held in `src/common_cpp/Plotting/SciFi`. They consist of a reduced tracker data container class, `TrackerData`, a series of plotting class based on ROOT, and a manager class `TrackerDataManager`, used to populate the `TrackerData` and call the various plotters. The plotters themselves inherit from a base class, `TrackerDataPlotterBase`. Each daughter class overloads the bracket operator, taking in arguments of two `TrackerData` objects, one per tracker, and a ROOT TCanvas, to plot on. The current types available are:

- **Info Box**: displays various information on the spill and run in text
- **Spacepoints**: displays spacepoint positions in $x - y$, $x - z$, and $y - z$
- **Tracks**: displays pattern recognition tracks in $x - y$, $x - z$, and $y - z$
- **XYZ**: calls Tracks and Spacepoints to display them both together
- **SZ**: displays pattern recognition tracks in $s - z$ (s being the distance swept out by a particle in the $x - y$ plane)

10.6.2 Tracker configuration variables

| Variable | Default | Description |
|------------------------------------|---------|--|
| SciFiMUXNum | 7 | |
| SciFiFiberDecayConst | 2.7 | |
| SciFiFiberConvFactor | 3047.1 | |
| SciFiFiberTrappingEff | 0.056 | |
| SciFiFiberMirrorEff | 0.6 | |
| SciFiFiberTransmissionEff | 0.8 | |
| SciFiMUXTransmissionEff | 1.0 | |
| SciFivlpcQE | 0.8 | |
| SciFivlpcEnergyRes | 4.0 | VLPC energy resolution (MeV) |
| SciFivlpcTimeRes | 0.2 | VLPC time resolution (ns) |
| SciFiadcFactor | 6.0 | |
| SciFitdcBits | 16 | |
| SciFitdcFactor | 1.0 | |
| SciFinPlanes | 3 | |
| SciFinStations | 5 | |
| SciFinTrackers | 2 | |
| SciFiNPECut | 2.0 | |
| SciFiClustExcept | 100 | |
| SciFi_sigma_tracker0_station5 | 0.4298 | Tracker 1 station 5 resolution (mm) |
| SciFi_sigma_triplet | 0.3844 | Spacepoint triplet resolution (mm) |
| SciFi_sigma_z | 0.081 | (mm) |
| SciFi_sigma_duplet | 0.6197 | (mm) |
| SciFiPRHelicalOn | True | Helical pattern recognition flag |
| SciFiPRStraightOn | True | Straight pattern recognition flag |
| SciFiRadiusResCut | 150.0 | Helix radius cut (mm) |
| SciFiNTurnsCut | 0.75 | Cut checking turns between stations is correct |
| SciFiMaxPt | 180.0 | Transverse momn. upper limit cut used in pat rec |
| SciFiMinPz | 180.0 | Longitudinal momn. lower limit cut used in pat rec |
| SciFiPerChanFlag | 0 | |
| SciFiNoiseFlag | 1.5 | |
| SciFiCrossTalkSigma | 50.0 | |
| SciFiCrossTalkAmplitude | 1.5 | |
| SciFiDarkCountProababilty | 0.017 | Probability of dark count due to thermal electrons |
| SciFiChannelCalibList | | Channel calibration data location |
| SciFiParams_Z | 5.61291 | |
| SciFiParams_Plane_Width | 0.6523 | |
| SciFiParams_Radiation_Legth | 424.0 | |
| SciFiParams_Density | 1.06 | |
| SciFiParams_Mean_Excitation_Energy | 68.7 | |
| SciFiParams_A | 104.15 | |
| SciFiParams_Pitch | 1.4945 | |
| SciFiParams_Station_Radius | 160. | |
| SciFiParams_RMS | 370. | |
| SciFiSeedCovariance | 1000 | Error estimate for seed values of the Kalman fit |
| SciFiKalman_use_MCS | True | Flag to add multiple scattering to the Kalman fit |
| SciFiKalman_use_Eloss | True | Flag to add energy loss to the Kalman fit |
| SciFiUpdateMisalignments | False | Do a misalignment search and update |
| SciFiKalmanVerbose | False | Dump information per fitted track |

10.7 The Monte Carlo

The tracker Monte Carlo can be run using the script at the beginning of the tracker section. In addition to the basic Monte Carlo noise from dark count in the VLPCs can be simulated by including the mapper `MapCppTrackerMCNoise`, which should be run before `MapCppTrackerMCDigitization`. Reconstruction after digitization is agnostic to source by design decision.

10.7.1 Station Geometry

The tracker geometry is built in Geant4 on a fibre-by-fibre basis. The size of the active tracker plane and the fibre diameter is defined in the mice modules. The fibre offset and translation are determined in code, the length of the fibres are then determined by its position within the plane. Fibre placement is then iterated over from one end of the plane to the other filling in all gaps within the area.

Each of the three scintillating fibre planes is built up this way. In addition to these the Monte Carlo also includes a thin layer of mylar sandwiched between these planes. The relative position of the three tracking planes and the three mylar layers within the station are defined in the mice modules.

10.7.2 MC VLPC Dark Count

When the mapper `MapCppTrackerMCNoise` is included in the MC each channel is tested for the presence of an integer number of PE randomly appearing in the data. The chance of this per channel noise is defined by the parameter `SciFiDarkCountProbabilty` within the data cards, while the number of PE generated is given by a Poisson distribution. If a noise hit is produced it is recorded to be passed to digitization later.

10.7.3 Building Digits

When a particle crosses a scintillating fibre in the MC it may deposit some amount of energy in passing determined by Geant4. The digitization process takes this deposited energy and transforms it into a number of PE as follows:

$$NPE = Energy * SciFiFiberConvFactor * SciFiFiberTrappingEff * (1.0 + SciFiFiberMirrorEff) * SciFiFiberTransmiss$$

(10.82)

Where the value of each of these variable other than the deposited energy is given in the data cards.

Hits in the same tracker, station, and plane are collected together to form a single digit. The grouping of digits are merged with any noise effects and a Gaussian smearing is applied to the total NPE to finish the digitization process.

Chapter 11

Global PID

11.1 Introduction

The global PID framework is designed to use sets of PID variables to 1) use MC data to create PDFs of these variables for a range of particle hypotheses, and 2) to use the PDFs as part of a log-likelihood method to determine the PID of reconstructed global tracks from data. The framework is designed such that new PID variables can be added as they are developed. Section 1 of this document will explain how to use the PID to produce PDFs, and how to perform PID on spill data contained within a Json document. Section 2 will detail how these two actions are performed within the code, and in Section 3 the PID variables, their structure, how new ones can be added to the framework, and details of those already in place, will be discussed. This document will be updated as the PID framework and variables continue to be developed.

11.1.1 Using the PID scripts

11.1.2 Producing PDFs

Whilst the PID framework comes with PDFs provided in `PIDhists.root`, it is possible for a user to produce PDFs for hypotheses not included within this file. The following describes how this should be done.

- Simulation: Production of MC data for a given particle hypothesis.
- Global Reconstruction: The MC data should then be passed through the global reconstruction. Detector information is currently to added to global tracks. Simulation and global recon can be performed by using the `simulate_global.py` script in `${MAUS_ROOT_DIR}/bin/Global`. As well as performing the simulation and TOF and Tracker reconstruction, this script also calls the mappers `MapCppGlobalReconImport` and `MapCppGlobalTrackMatching`, which import the detector information into the global event and then construct the global tracks required for the calculation of PID variables. The control variable to specify the name of the output Json file that contains the reconstructed tracks can be set at the command line, or by using another datacard, as shown in listing 11.1. To run the global reconstruction with the datacard, the following should be entered at the command line:

```
> ${MAUS_ROOT_DIR}/bin/Global/simulate_global.py \  
    --configuration_file <name_of_datacard>
```

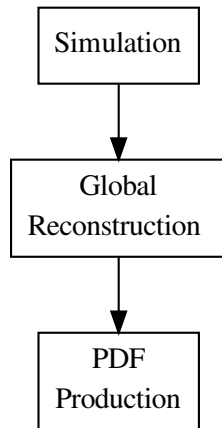

Figure 11.1: Steps involved in producing a PDF from MC data

which for the example in 11.1 would be:

```
> ${MAUS_ROOT_DIR}/bin/Global/simulate_global.py \
    --configuration_file ex_global_datacard.py
```

- PDF Production: To produce the PDFs from the reconstructed MC data, `pid_pdf_production.py` in `${MAUS_ROOT_DIR}/bin/Global` is then used. This script calls the reducer `ReduceCppGlobalPID`. With this script, a datacard, such as that shown given in listing 11.2, that includes the input Json filename, the `global_pid_hypothesis` for which the PDF(s) are to be produced, and a `unique_identifier` (typically the time and date at which the script is run) is used by entering at the command line:

```
> ${MAUS_ROOT_DIR}/bin/Global/pid_pdf_generator.py \
    --configuration_file example_pdf_datacard.py
```

This will create a directory within `${MAUS_ROOT_DIR}/files/PID` corresponding to the hypothesis and identifier given by the datacard, which will then contain files for each PID variable, each of which will contain the PDF for that hypothesis and variable.

```
import os

# A json document containing spills from MC data
input_json_file_name = "example_hypothesis.json"
input_json_file_type = "text"

# The json document that the global tracks will be
# written to
output_json_file_name =
```

```
"example_hypothesis_Global_Recon.json"
output_json_file_type = "text"
```

Listing 11.1: An example datacard (ex_global_datacard.py) for use with GlobalReconImport.py Other configuration flags can be added to this datacard, if they need to differ from those set in ConfigurationDefaults.py

```
import os
import datetime

# Use the current time and date as a unique
# identifier when creating files to contain PDFs.
# A unique_identifier is required by the reducer,
# and PDF production will fail without one.
now = datetime.datetime.now()
unique_identifier =
    now.strftime("%Y_%m_%dT%H_%M_%S_%f")

# A json document containing global tracks from MC
# data
input_json_file_name =
    "example_hypothesis_Global_Recon.json"
input_json_file_type = "text"

# The particle hypothesis that the PDF is being
# created for. A global_pid_hypothesis is required
# by the reducer, and PDF production will fail
# without one.
global_pid_hypothesis = "example"
```

Listing 11.2: An example datacard (example_pdf_datacard.py) for use with pid_pdf_generator.py

Performing PID with pre-existing hypotheses

To perform PID on data, the steps shown figure 11.2 should be followed.

- Data: This can be experimental or MC data, however the spill data must be passed to the PID in a Json document.
- Global Reconstruction: In the same way as described above, the data should then be passed through the global reconstruction, currently using the GlobalReconImport.py script in $\{\text{MAUS_ROOT_DIR}\}\backslash\text{bin}\backslash\text{Global}$, with a corresponding datacard containing the name of the input Json file and the name of the output file.
- Global PID: To perform the PID on the reconstructed data, GlobalPID.py in $\{\text{MAUS_ROOT_DIR}\}\backslash\text{bin}\backslash\text{Global}$ is then used. This script calls the MapCppGlobalPID mapper. With this script, a datacard, such as that shown given in listing 11.3, that includes the input and output Json filenames, is used, by entering the following at the command line:

```
>  $\{\text{MAUS\_ROOT\_DIR}\}/\text{bin}/\text{Global}/\text{GlobalPID.py} \backslash$ 
    --configuration_file example_pid_datacard.py
```

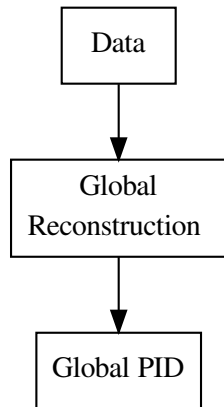

Figure 11.2: Steps involved in performing the PID for a data sample

```

import os

# A json document containing spills from data
input_json_file_name =
    "example_hypothesis_Global_Recon.json"
input_json_file_type = "text"

# The json document that the global tracks will be
# written to
output_json_file_name =
    "example_hypothesis_Global_PID.json"
output_json_file_type = "text"
  
```

Listing 11.3: An example datacard (example_pid_datacard.py) for use with GlobalPID.py

As the framework currently stands, the output document would now contain the global tracks with the PID set (where it has been possible to do so) to whichever particle hypothesis had the highest log-likelihood. For tracks where the PID could not be determined, the track PID will be left as 0.

11.2 MapCppGlobalPID and ReduceCppGlobalPID

11.2.1 MapCppGlobalPID

The steps taken in MapCppGlobalPID for a single track are shown in figure 11.3. To express this more fully, the data, having passed through the global reconstruction, is then passed to the PID. For each track, the values of each PID variable are calculated. Each of these values is then compared to the corresponding PDFs for all particle hypotheses, the number of entries in the corresponding bin providing the probability from which the log-likelihood is calculated. For each particle hypothesis, the log-likelihoods of all of the PID

variables are summed to give a log-likelihood for that hypothesis. The PID of the track is then obtained by comparing the log-likelihoods of the hypotheses.

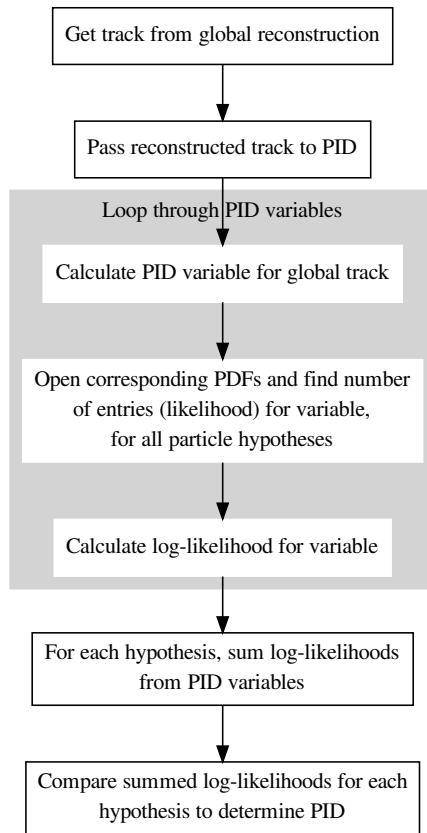

Figure 11.3: Flow chart detailing steps taken in MapCppGlobalPID

11.3 ReduceCppGlobalPID

The steps taken in ReduceCppGlobalPID are shown in figure 11.4. MC data for a given particle hypothesis, having passed through the global reconstruction, is then passed to the PID. For each track, the values of each PID variable are calculated. A histogram is filled with these values. If the behaviour has been turned on in the PID variable class, then a single event is spread over all bins in the histogram, to ensure that when the PDF is used by the PID, there will be no empty bins, thus avoiding cases where the log-likelihood takes the log of zero. The histogram is then normalised to create the PDF, which is then written and saved to file. If a MC track returns a variable value outside of the allowed range of the histogram (as defined within the variable class) then the value for that track is not included.

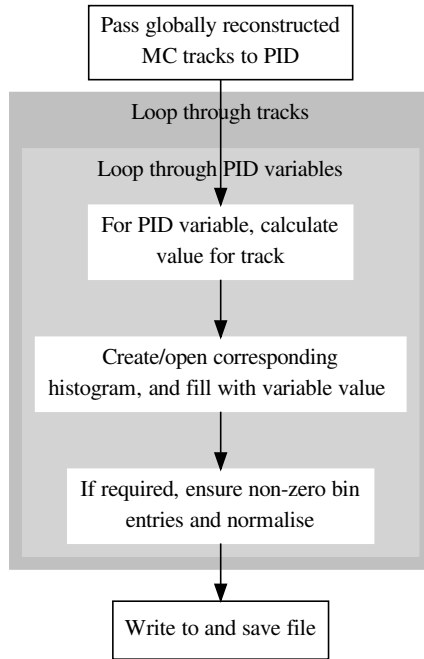

Figure 11.4: Flow chart detailing steps taken in ReduceCppGloboPID

11.4 PID Variables

Information from the MICE detectors will be incorporated into a set of PID variables that can be used to distinguish between particle hypotheses. The Global PID framework has been written such that any number of PID variables can be developed and added as necessary, all represented by their own class, derived from a base class.

11.4.1 PID Base Class

The base PID class (PIDBase.hh and .cc) contains the functions to:

- Create the PDFs (and the files that contain them)
- Use the PDFs with globally reconstructed tracks
- Populate the PDFs with variable values (after checking that value is valid)
- Perform the log-likelihood for an incoming globally reconstructed track (after checking that value of variable for track falls within range of PDF).
- Calculate the value of the PID variable (this is a virtual function to be defined in the derived classes)

11.4.2 PID Variable Classes

Each PID variable will be implemented in a derived class of the base PID class. Because of how the framework is designed, new variables can be added as they

are developed.

Adding PID Variables

In each derived variable class, the following should be included:

- The variable name should be set
- The function to calculate the PID variable should be defined.
- The minimum, maximum, and number of bins for PDFs created using the variable should be set. The values of the minimum and maximum define the allowed range of values that the PID variable can take.
- In some cases it may be necessary to ensure that all bins in a PDF return non zero entries, and so by setting the variable `_nonZeroHistEntries` to true, a single event spread across all bins will be added

PIDVarA

PIDVarA (see PIDVarA.hh and .cc), uses the difference between the times measured at TOF1 and TOF0 as its variable. Only for tracks where there is a single TOF0 and a single TOF1 time measurement, and for which the time difference between the detectors falls within the minimum and maximum set within the class, will a valid value of the variable be returned. Otherwise, the value of the variable is set to -1, such that it falls outside of the allowed range for the variable, and so variable for the track is not used in PDF production, or in the PID. A point to note with PIDVarA is that it is momentum dependent, and so may not be included as a final PID variable.

PIDVarB

PIDVarB uses the correlation between the momentum measured in the upstream tracker and the difference between the times measured at TOF1 and TOF0 as its variable, returning the two values as a std pair. It places the same constraints on accepted tracks as those used in PIDVarA, that there must be a single TOF0 and TOF1 time measurement, and for which the time difference between the detectors falls within the minimum and maximum set within the class, will a valid value of the variable be returned. The tracker must also return a valid momentum measurement for a valid variable to be returned. Otherwise, the value of the variable is set to (-1,-1), such that it falls outside of the allowed range for the variable, and so variable for the track is not used in PDF production, or in the PID.

Chapter 12

The Envelope Tool

The MAUS envelope tool is intended as a tool to support lattice development and enable visualisation of the MICE accelerator for online use. The tool facilitates the visualisation of field elements, propagation of particles and beams ellipses through those elements.

The envelope tool is intended for use with mostly straight beamlines.

12.1 Example Usage

To call the envelope tool with some example data, source the MAUS environment and then do

```
$ python ${MAUS_ROOT_DIR}/bin/utilities/envelope_tool/envelope_tool.py \  
  --configuration_file ${MAUS_ROOT_DIR}/bin/utilities/envelope_tool/share/pseudobeamline.py
```

12.2 Envelope Tool main window

The Main Window enables the user to view the selected lattice parameters, and provides buttons to update the beam, lattice and plot parameters.

- Beam Setup: setup a beam
- Magnet Setup: setup fields
- Plot Setup: setup the plot
- Exit: exit the GUI

12.3 Beam Setup

The Beam Setup window enables the user to set beam parameters. The top few cells set initial position, momentum and particle type of the beam centroid, also referred to as the 'reference particle' or 'reference trajectory'. The bottom few cells set beam ellipse parameters.

Helper windows can be accessed to parameterise the beam ellipse using either a Penn parameterisation or a Twiss parameterisation.

- x, y, z: initial position of the beam particle
- px, py, pz: initial momentum of the beam particle

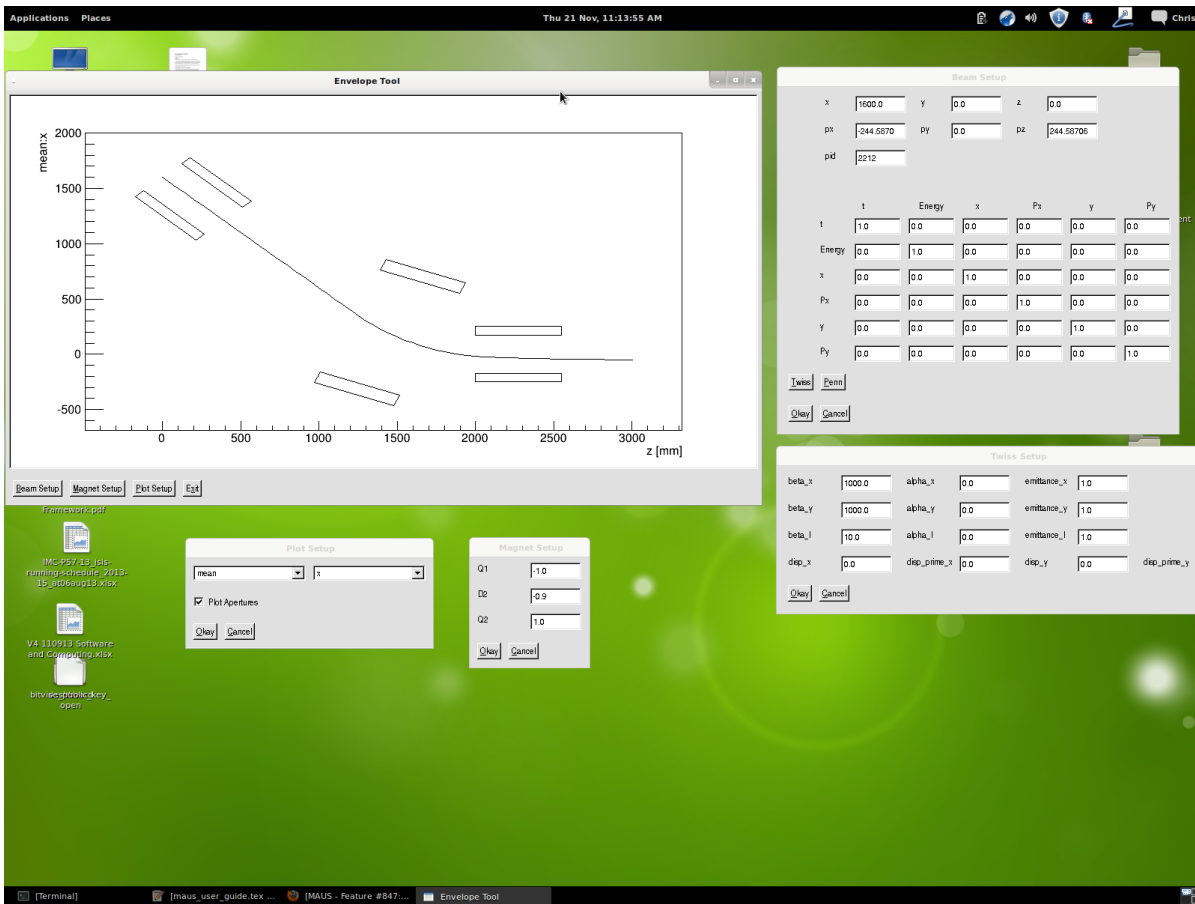

Figure 12.1: The Envelope Tool used to plot a reference trajectory through a few magnets.

- pid: PDG ID of the beam particle. This is an integer; see Tab. ?? for some common particle ids.
- ellipse elements: set the elements of the beam ellipse. The matrix must be symmetric and positive definite or an error will be returned when Okay is pressed.
- Twiss: setup the beam using a Twiss parameterisation - beam asymmetric in x and y with no coupling
- Penn: setup the beam using a Penn parameterisation - beam cylindrically symmetric in x and y with angular momentum
- Okay: click okay to return to the main window, updating the beam ellipse
- Cancel: click cancel to return to the main window, losing changes

12.4 Magnet Setup

The user can manipulate magnet parameters in this window. When the window is opened, MiceModules which have the following required parameters are added to the window.

- FieldType (string)
- FieldName (string)
- Position (hep three vector)
- Rotation (hep three vector)
- ScaleFactor (double)
- NominalAperture (hep three vector)
- NominalOuter (hep three vector)

Other MiceModules will be ignored.

Each magnet is labelled with the magnet FieldName and a text entry is available to set the scale factor (proportional to field).

- <field entries>: Enter a float to set the scale factor.
- Okay: Update the fields in the lattice
- Cancel: Cancel changes

12.5 Plot Setup

The Plot Setup window enables the user to select the desired plot parameters.

- Plot Type: Select the type of variable to plot.
- Plot Variable: Select the variable to plot.
- Plot Apertures: tick to plot physical apertures. If the plot type is **mean** or **envelope** and plot variable is **x** or **y** the apertures will be plotted as a 2D projection of the physical apertures in the appropriate plane, with the beam reference trajectory or beam envelope superimposed. Note that the rotations applied here are rather simplistic, assuming a 2D geometry in x or y plane (but not both) Otherwise nominal apertures will be scaled to fit in the upper portion of the plotting window.
- Okay: Update the plot in the main window with the new selection.
- Cancel: Cancel changes

Chapter 13

G4beamline-MAUS Integration

This chapter describes how to run G4beamline as a third-party app with MAUS. G4beamline is used to model the MICE beam line from the target to the Geneva 1 counter which is just upstream of D2. It provides a realistic beam description which can be used to seed downstream simulations in MAUS. The user must include the mapper `MapPyBeamlineSimulation.py` in `simulate_mice.py` to use G4beamline to create MAUS primaries. Also the mapper `MapPyBeamMaker` must be commented out to prevent two beams, one from G4beamline and one gaussian, being created. The beam line settings can be controlled with the dictionary `g4bl` (table 13.1) in the MAUS datacard.

The default configuration variables simulate a 6π 200 MeV/c positive beam using the Geneva 1 counter as the interface point. This can be used as input for the MAUS Step IV geometry provided by the Geometry group. To generate MAUS primaries for beams of different momenta or at difference interfaces (i.e. for different MAUS geometries) these variables must be changed accordingly.

The output of this mapper is a json document of MAUS primaries. This is passed directly to `MapPyBeamMaker.py` and so simulations of the entire MICE beam line from end-to-end can be run. However given the requisite time required to complete such a simulation this is not recommended. Large scale production jobs will be run on the Grid using this mapper to create beam libraries. These are publically available from (details to be decided).

The output json document from this mapper is called `G4BLoutput.json` and is written in whichever directory `simulate_mice.py` was run. It can be used directly with the inputter `InputPyJSON.py`. To use this include the inputter in `simulate_mice.py` and set the path to `G4BLoutput.json` in the MAUS datacard using the variable `input_json_file_name`. With the beam description set as shown above a MAUS simulation with an input beam from G4beamline can be run with:

```
./simulate_mice.py --configuration_file MAUS_Datacard.py
```

Alternatively the file downloaded from the beam library will be in the same format and can be used similarly with the same inputter.

Table 13.1: G4BL parameters

| <i>MAUS will write the following variables to the G4BL configuration file</i> | |
|---|--|
| q_1, q_2, q_3, d_1, d_s, d_2 | Field gradient of magnet |
| particles_per_spill | No. of particles to take out of buffer for each spill, if set to zero then all particles are taken from buffer for first spill |
| run_number | When retrieving magnet currents and proton absorber thickness from CDB set to the run number of interest |
| rotation_angle | Rotation of MAUS co-ordinate system clockwise around the y-axis with respect to G4BL co-ordinate system |
| translation_z | The distance between the MAUS centre and the G4BL centre. It assumes the G4BL centre is in front of the MAUS centre |
| proton_absorber_thickness | Thickness of the proton absorber |
| proton_number | No. of protons on target in G4BL |
| proton_weight | Scales the number of protons generated, with default setting protons are NOT generated |
| particle_charge | Refers to the charge of the simulated particles. Can be set to, positive-only, negative-only or all |
| file_path | Path to G4BL input |
| get_magnet_currents_pa_cdb | If set to True all magnet currents and proton absorber thickness will be retrieved from the CDB and written to the G4BL configuration file for the run number given in this dictionary |

Chapter 14

Appendix C: Tracker Appendices

14.1 Kuno's Conjecture

For a given triplet space-point, the sum of the channel number of each cluster will be a constant.

To see how this comes about, consider the coordinate system defined by the u , v and w axes in the station reference frame shown in figure 14.1. The u , v and w coordinates may be written in terms of the polar coordinates (r, ϕ) as follows:

$$u = r \cos[\phi] \quad (14.1)$$

$$v = r \cos \left[\frac{2\pi}{3} - \phi \right] \quad (14.2)$$

$$w = r \cos \left[\frac{4\pi}{3} - \phi \right] \quad (14.3)$$

The sum $u + v + w$ may now be written:

$$u + v + w = r \left\{ \cos \phi + \cos \left[\frac{2\pi}{3} - \phi \right] + \cos \left[\frac{4\pi}{3} - \phi \right] \right\} \quad (14.4)$$

$$= r \left\{ \cos \phi + \left[\cos \left(\frac{2\pi}{3} \right) \cos \phi + \sin \left(\frac{2\pi}{3} \right) \sin \phi \right] + \right. \quad (14.5)$$

$$\left. \left[\cos \left(-\frac{2\pi}{3} \right) \cos \phi + \sin \left(-\frac{2\pi}{3} \right) \sin \phi \right] \right\} \quad (14.6)$$

$$= r \left\{ \cos \phi + 2 \cos \left(\frac{2\pi}{3} \right) \cos \phi \right\} \quad (14.7)$$

$$= r \{ \cos \phi + [-\cos \phi] \} \quad (14.8)$$

$$= 0 \quad (14.9)$$

If the sum is performed using the fibre numbers for the channels hit, the sum of the the three views will equal the sum of the central-fibre numbers, i.e. if the central fibre numbers of each of the u , v and w doublet-layers is 106.5, then the sum of channel numbers will be $106.5 + 106.5 + 105.5 = 318.5$.

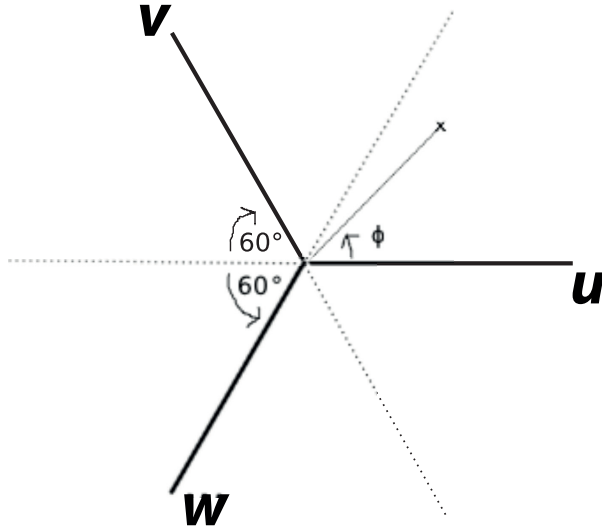

Figure 14.1: Schematic representation of a point and the three plane orientations.

14.2 Space-point variance

Figure 10.9 shows the arrangement of the fibre channels in the tracker. The regions in which a space point will be reconstructed are shown by the shaded areas. The area of the triangular intersection is given by:

$$A = 4 \frac{1}{2} \frac{c_p}{\sqrt{3}} \frac{c_p}{2} \quad (14.10)$$

$$= \frac{c_p^2}{\sqrt{3}}; \quad (14.11)$$

where c_p is the channel pitch. Therefore, for the triangular intersection, the mean values of x and y are given by:

$$\bar{x} = \frac{1}{A} \int \int x dx dy \quad (14.12)$$

$$= \frac{1}{A} \int_0^{c_p} x dx \int_{-\frac{x}{\sqrt{3}}}^{\frac{x}{\sqrt{3}}} dy \quad (14.13)$$

$$= \frac{1}{A} \frac{2}{\sqrt{3}} \int_0^{c_p} x^2 dx \quad (14.14)$$

$$= \frac{1}{A} \frac{2}{\sqrt{3}} \frac{c_p^3}{3} \quad (14.15)$$

$$= \frac{\sqrt{3}}{c_p^2} \frac{2}{\sqrt{3}} \frac{c_p^3}{3} \quad (14.16)$$

$$= \frac{2}{3} c_p; \text{ and} \quad (14.17)$$

$$\bar{y} = \frac{1}{A} \int \int y dx dy \quad (14.18)$$

$$= \frac{1}{A} \int_0^{c_p} dx \int_{-\frac{x}{\sqrt{3}}}^{\frac{x}{\sqrt{3}}} y dy \quad (14.19)$$

$$= \frac{1}{A} \int_0^{c_p} \left[\frac{y^2}{2} \right]_{-\frac{x}{\sqrt{3}}}^{\frac{x}{\sqrt{3}}} dx \quad (14.20)$$

$$= 0. \quad (14.21)$$

The variance of the x and y coordinates are then given by:

$$V_x = \sigma_x^2 = \frac{1}{A} \int \int (x - \bar{x})^2 dx dy \quad (14.22)$$

$$= \frac{1}{A} \int_0^{c_p} dx \int_{-\frac{x}{\sqrt{3}}}^{\frac{x}{\sqrt{3}}} (x - \bar{x})^2 dy \quad (14.23)$$

$$= \frac{1}{A} \frac{2}{\sqrt{3}} \int_0^{c_p} x(x - \bar{x})^2 dx \quad (14.24)$$

$$= \frac{1}{A} \frac{2}{\sqrt{3}} \int_0^{c_p} (x^3 - 2x^2\bar{x} + \bar{x}^2x) dx \quad (14.25)$$

$$= \frac{1}{A} \frac{2}{\sqrt{3}} \int_0^{c_p} (x^3 - \frac{4}{3}c_p x^2 + \frac{4}{9}c_p^2 x) dx \quad (14.26)$$

$$= \frac{1}{A} \frac{2}{\sqrt{3}} \left[\frac{x^4}{4} - \frac{4}{9}c_p x^3 + \frac{2}{9}c_p^2 x^2 \right]_0^{c_p} \quad (14.27)$$

$$= \frac{c_p^4}{A} \frac{2}{\sqrt{3}} \left[\frac{1}{4} - \frac{4}{9} + \frac{2}{9} \right] \quad (14.28)$$

$$= \frac{c_p^4}{A} \frac{2}{\sqrt{3}} \left[\frac{1}{4} - \frac{2}{9} \right] \quad (14.29)$$

$$= c_p^4 \frac{\sqrt{3}}{c_p^2} \frac{2}{\sqrt{3}} \frac{1}{36} \quad (14.30)$$

$$= \frac{1}{18} c_p^2 \quad (14.31)$$

$$V_x = \sigma_x^2 = \left(\frac{c_p}{3\sqrt{2}} \right)^2 ; \quad (14.32)$$

$$V_y = \sigma_y^2 = \frac{1}{A} \int_0^{c_p} dx \int_{-\frac{x}{\sqrt{3}}}^{\frac{x}{\sqrt{3}}} (y - \bar{y})^2 dy \quad (14.33)$$

$$= \frac{1}{A} \int_0^{c_p} \left[\frac{y^3}{3} \right]_{-\frac{x}{\sqrt{3}}}^{\frac{x}{\sqrt{3}}} dy \quad (14.34)$$

$$= \frac{1}{A} \frac{2}{3\sqrt{3}} \int_0^{c_p} x^3 dx \quad (14.35)$$

$$= \frac{1}{A} \frac{2}{9\sqrt{3}} \left[\frac{x^4}{4} \right]_0^{c_p} \quad (14.36)$$

$$= \frac{1}{A} \frac{2}{9\sqrt{3}} \frac{c_p^4}{4} \quad (14.37)$$

$$= \frac{1}{9} \frac{c_p^2}{2} \quad (14.38)$$

$$= \frac{1}{18} c_p^2 \quad (14.39)$$

$$V_y = \sigma_y^2 = \left(\frac{c_p^2}{3\sqrt{2}} \right)^2. \quad (14.40)$$

The covariance is given by:

$$V_{xy} = \frac{1}{A} \int \int (x - \bar{x})(y - \bar{y}) dx dy \quad (14.41)$$

$$= \frac{1}{A} \int_0^{c_p} (x - \bar{x}) dx \int_{-\frac{x}{\sqrt{3}}}^{\frac{x}{\sqrt{3}}} (y - \bar{y}) dy \quad (14.42)$$

$$= \frac{1}{A} \int_0^{c_p} (x - \bar{x}) \left[\frac{1}{2} y^2 - y\bar{y} \right]_{-\frac{x}{\sqrt{3}}}^{\frac{x}{\sqrt{3}}} \quad (14.43)$$

$$= 0. \quad (14.44)$$

Therefore:

$$\sigma_x = \sigma_y = \frac{c_p}{3\sqrt{2}} = 384.4 \mu\text{m}. \quad (14.45)$$

For the hexagonal case, the area of the overlapping region (shaded zone in the right panel of figure 10.9) is given by:

$$A = 6 \frac{1}{2} \frac{c_p}{\sqrt{3}} \frac{c_p}{2} \quad (14.46)$$

$$= \frac{\sqrt{3}}{2} c_p^2. \quad (14.47)$$

By symmetry, $\bar{x} = \bar{y} = 0$. The variance of the x and y coordinates are given by:

$$V_x = \sigma_x^2 = \sigma_y^2 = \frac{1}{A} \int \int (x - \bar{x})^2 dx dy \quad (14.48)$$

$$= \frac{1}{A} \int \int x^2 dx dy \quad (14.49)$$

$$= \frac{2}{A} \int_{-\frac{c_p}{2}}^0 x^2 dx \int_{-\frac{x}{\sqrt{3}} - \frac{c_p}{\sqrt{3}}}^{\frac{x}{\sqrt{3}} + \frac{c_p}{\sqrt{3}}} dy$$

$$= \frac{2}{A} \int_{-\frac{c_p}{2}}^0 x^2 \left[2 \left(\frac{x}{\sqrt{3}} + \frac{c_p}{\sqrt{3}} \right) \right] dx \quad (14.50)$$

$$= \frac{2}{A} \frac{2}{\sqrt{3}} \int_{-\frac{c_p}{2}}^0 (x^3 + x^2 c_p) dx$$

$$= \frac{2}{A} \frac{2}{\sqrt{3}} \left[\frac{1}{4} x^4 + \frac{1}{3} x^3 c_p \right]_{-\frac{c_p}{2}}^0 \quad (14.51)$$

$$= \frac{2}{A} \frac{2}{\sqrt{3}} \left[-\frac{1}{4} \frac{c_p^4}{16} + \frac{1}{3} \frac{c_p^4}{8} \right] \quad (14.52)$$

$$= \frac{2}{A} \frac{2}{\sqrt{3}} \left[\frac{1}{8} \left(\frac{1}{3} - \frac{1}{8} \right) c_p^4 \right] \quad (14.53)$$

$$= \frac{2}{A} \frac{2}{\sqrt{3}} \frac{1}{8} \frac{5}{24} c_p^4 = \frac{1}{A} \frac{5}{48\sqrt{3}} c_p^4 \quad (14.54)$$

$$= \frac{2}{\sqrt{3} c_p^2} \frac{5}{48\sqrt{3}} c_p^4 = \frac{2}{\sqrt{3}} \frac{5}{48\sqrt{3}} c_p^2 \quad (14.55)$$

$$= \left(\sqrt{\frac{5}{2}} \frac{c_p}{6} \right)^2. \quad (14.56)$$

As before, the covariance is given by:

$$V_{xy} = \frac{1}{A} \int \int (x - \bar{x})(y - \bar{y}) dx dy \quad (14.57)$$

$$= \frac{2}{A} \int_{-\frac{c_p}{2}}^0 x dx \int_{-\frac{x}{\sqrt{3}} - \frac{c_p}{\sqrt{3}}}^{\frac{x}{\sqrt{3}} + \frac{c_p}{\sqrt{3}}} y dy$$

$$= \frac{2}{A} \int_{-\frac{c_p}{2}}^0 x dx \left[\frac{1}{2} y^2 \right]_{-\frac{x}{\sqrt{3}} - \frac{c_p}{\sqrt{3}}}^{\frac{x}{\sqrt{3}} + \frac{c_p}{\sqrt{3}}}$$

$$= 0. \quad (14.58)$$

Therefore:

$$\sigma_x = \sigma_y = \sqrt{\frac{5}{2}} \frac{c_p}{6} = 429.8 \mu\text{m}. \quad (14.59)$$

14.3 Circle parameters from three points

A circle in the plane $z = 0$ may be parameterised as:

$$(x - X_0)^2 + (y - Y_0)^2 = \rho^2; \quad (14.60)$$

where (X_0, Y_0) is the position of the centre of the circle and ρ is its radius. Expanding:

$$(x^2 + y^2) - 2X_0 x - 2Y_0 y = \rho^2 - (X_0^2 + Y_0^2); \quad (14.61)$$

which implies:

$$\frac{(x^2 + y^2)}{\rho^2 - (X_0^2 + Y_0^2)} - \frac{2X_0x}{\rho^2 - (X_0^2 + Y_0^2)} - \frac{2Y_0y}{\rho^2 - (X_0^2 + Y_0^2)} = 1. \quad (14.62)$$

The circle may be parameterised:

$$\alpha(x^2 + y^2) + \beta x + \gamma y + \kappa = 0; \quad (14.63)$$

where:

$$\alpha = \frac{1}{\rho^2 - (X_0^2 + Y_0^2)}; \quad (14.64)$$

$$\beta = -2X_0\alpha; \quad (14.65)$$

$$\gamma = -2Y_0\alpha; \quad (14.66)$$

$$\kappa = -1. \quad (14.67)$$

These equations are readily inverted to yield:

$$X_0 = \frac{-\beta}{2\alpha}; \quad (14.68)$$

$$Y_0 = \frac{-\gamma}{2\alpha}; \quad (14.69)$$

$$\rho = \sqrt{\frac{\beta^2 + \gamma^2}{4\alpha^2} - \frac{\kappa}{\alpha}}. \quad (14.70)$$

The equation of a circle passing through three points (x_i, y_i) , where $i = 1, 2, 3$ can be found from:

$$\begin{vmatrix} x^2 + y^2 & x & y & 1 \\ x_1^2 + y_1^2 & x_1 & y_1 & 1 \\ x_2^2 + y_2^2 & x_2 & y_2 & 1 \\ x_3^2 + y_3^2 & x_3 & y_3 & 1 \end{vmatrix} = 0; \quad (14.71)$$

which can be re-written as:

$$(x^2 + y^2) \begin{vmatrix} x_1 & y_1 & 1 \\ x_2 & y_2 & 1 \\ x_3 & y_3 & 1 \end{vmatrix} - x \begin{vmatrix} x_1^2 + y_1^2 & y_1 & 1 \\ x_2^2 + y_2^2 & y_2 & 1 \\ x_3^2 + y_3^2 & y_3 & 1 \end{vmatrix} + y \begin{vmatrix} x_1^2 + y_1^2 & x_1 & 1 \\ x_2^2 + y_2^2 & x_2 & 1 \\ x_3^2 + y_3^2 & x_3 & 1 \end{vmatrix} - \begin{vmatrix} x_1^2 + y_1^2 & x_1 & y_1 \\ x_2^2 + y_2^2 & x_2 & y_2 \\ x_3^2 + y_3^2 & x_3 & y_3 \end{vmatrix} = 0. \quad (14.72)$$

Comparing this relation with equation 14.63:

$$\alpha = \frac{\begin{vmatrix} x_1 & y_1 & 1 \\ x_2 & y_2 & 1 \\ x_3 & y_3 & 1 \end{vmatrix}}{\begin{vmatrix} x_1^2 + y_1^2 & x_1 & y_1 \\ x_2^2 + y_2^2 & x_2 & y_2 \\ x_3^2 + y_3^2 & x_3 & y_3 \end{vmatrix}} \quad (14.73)$$

$$\beta = - \frac{\begin{vmatrix} x_1^2 + y_1^2 & y_1 & 1 \\ x_2^2 + y_2^2 & y_2 & 1 \\ x_3^2 + y_3^2 & y_3 & 1 \end{vmatrix}}{\begin{vmatrix} x_1^2 + y_1^2 & x_1 & y_1 \\ x_2^2 + y_2^2 & x_2 & y_2 \\ x_3^2 + y_3^2 & x_3 & y_3 \end{vmatrix}} \quad (14.74)$$

$$\gamma = \frac{\begin{vmatrix} x_1^2 + y_1^2 & x_1 & 1 \\ x_2^2 + y_2^2 & x_2 & 1 \\ x_3^2 + y_3^2 & x_3 & 1 \end{vmatrix}}{\begin{vmatrix} x_1^2 + y_1^2 & x_1 & y_1 \\ x_2^2 + y_2^2 & x_2 & y_2 \\ x_3^2 + y_3^2 & x_3 & y_3 \end{vmatrix}} \quad (14.75)$$

$$\kappa = - \frac{\begin{vmatrix} x_1^2 + y_1^2 & x_1 & y_1 \\ x_2^2 + y_2^2 & x_2 & y_2 \\ x_3^2 + y_3^2 & x_3 & y_3 \end{vmatrix}}{\begin{vmatrix} x_1^2 + y_1^2 & x_1 & y_1 \\ x_2^2 + y_2^2 & x_2 & y_2 \\ x_3^2 + y_3^2 & x_3 & y_3 \end{vmatrix}}. \quad (14.76)$$

Noting that:

$$\left(x + \frac{\beta}{2\alpha}\right)^2 + \left(y + \frac{\gamma}{2\alpha}\right)^2 = \left(\sqrt{\frac{\beta^2 + \gamma^2}{4\alpha^2} - \frac{\kappa}{\alpha}}\right)^2. \quad (14.77)$$

the position of the centre of the circle, (X_0, Y_0) and its radius, ρ , are given by equations 14.68 to 14.70.

14.4 Helical Track Pattern Recognition

The equation of motion of a charged particle in an external magnetic field can be written as

$$\frac{d^2x}{ds^2} = \frac{q}{p} \left(\frac{d\vec{x}}{ds} \right) \times \vec{B}(s) \quad (14.78)$$

If we assume that the magnetic field lies along the z axis $\vec{B} = (0, 0, B)$, then the three scalar components of it can be written as

$$\begin{aligned} \frac{d^2x}{ds^2} &= \frac{q}{P} \left(\frac{dy}{ds} \right) B \\ \frac{d^2y}{ds^2} &= -\frac{q}{P} \left(\frac{dx}{ds} \right) B \\ \frac{d^2z}{ds^2} &= 0 \end{aligned} \quad (14.79)$$

we also note that P is the total momentum and the transverse momentum $p_t = P \cos \lambda = qBR_H$ can be written as

$$\begin{aligned} p_x &= p_t \cos \phi \\ p_y &= -p_t \sin \phi \end{aligned} \quad (14.80)$$

the solution of the above equations will be a helix

$$\begin{aligned} x(s) &= x_1 + R \left[\cos \left(\Phi_0 + \frac{hs \cos \lambda}{R} \right) - \cos \Phi_0 \right] \\ y(s) &= y_1 + R \left[\sin \left(\Phi_0 + \frac{hs \cos \lambda}{R} \right) - \sin \Phi_0 \right] \\ z(s) &= z_1 + s \sin \lambda \end{aligned} \quad (14.81)$$

where x_1, y_1 and z_1 is the starting point. R is the radius of the helix. $h = \pm 1$ is the sense of the rotation in $x - y$ plane. We note that

$$\begin{aligned} ds^2 &= dx^2 + dy^2 + dz^2 \\ ds/dz &= (1 + \dot{x}^2 + \dot{y}^2)^{1/2} \\ \left(\frac{dx}{ds} \right)^2 + \left(\frac{dy}{ds} \right)^2 + \left(\frac{dz}{ds} \right)^2 &= 1 \end{aligned} \quad (14.82)$$

On the other hand, the equation of a circle passing through three space points (x_i, y_i) , where $i = 1, 2, 3$ can be found from the following determinant.

$$\begin{vmatrix} x^2 + y^2 & x & y & 1 \\ x_1^2 + y_1^2 & x_1 & y_1 & 1 \\ x_2^2 + y_2^2 & x_2 & y_2 & 1 \\ x_3^2 + y_3^2 & x_3 & y_3 & 1 \end{vmatrix} = 0 \quad (14.83)$$

which can be re-written as

$$(x^2 + y^2) \begin{vmatrix} x_1 & y_1 & 1 \\ x_2 & y_2 & 1 \\ x_3 & y_3 & 1 \end{vmatrix} - x \begin{vmatrix} x_1^2 + y_1^2 & y_1 & 1 \\ x_2^2 + y_2^2 & y_2 & 1 \\ x_3^2 + y_3^2 & y_3 & 1 \end{vmatrix} + y \begin{vmatrix} x_1^2 + y_1^2 & x_1 & 1 \\ x_2^2 + y_2^2 & x_2 & 1 \\ x_3^2 + y_3^2 & x_3 & 1 \end{vmatrix} - \begin{vmatrix} x_1^2 + y_1^2 & x_1 & y_1 \\ x_2^2 + y_2^2 & x_2 & y_2 \\ x_3^2 + y_3^2 & x_3 & y_3 \end{vmatrix} = 0 \quad (14.84)$$

comparing the above relation with the conventional circle equation

$$a(x^2 + y^2) + dx + ey + f = 0 \quad (14.85)$$

or

$$\left(x + \frac{d}{2a}\right)^2 + \left(y + \frac{e}{2a}\right)^2 = \left(\sqrt{\frac{d^2 + e^2}{4a^2} - \frac{f}{a}}\right)^2 \quad (14.86)$$

we find that

$$a = \begin{vmatrix} x_1 & y_1 & 1 \\ x_2 & y_2 & 1 \\ x_3 & y_3 & 1 \end{vmatrix} \quad (14.87)$$

$$d = - \begin{vmatrix} x_1^2 + y_1^2 & y_1 & 1 \\ x_2^2 + y_2^2 & y_2 & 1 \\ x_3^2 + y_3^2 & y_3 & 1 \end{vmatrix} \quad (14.88)$$

$$e = \begin{vmatrix} x_1^2 + y_1^2 & x_1 & 1 \\ x_2^2 + y_2^2 & x_2 & 1 \\ x_3^2 + y_3^2 & x_3 & 1 \end{vmatrix} \quad (14.89)$$

$$f = - \begin{vmatrix} x_1^2 + y_1^2 & x_1 & y_1 \\ x_2^2 + y_2^2 & x_2 & y_2 \\ x_3^2 + y_3^2 & x_3 & y_3 \end{vmatrix} \quad (14.90)$$

and also the centre and the radius of the circle will be

$$\begin{aligned} x_0 &= -\frac{d}{2a} \\ y_0 &= -\frac{e}{2a} \\ R &= \sqrt{\frac{d^2 + e^2}{4a^2} - \frac{f}{a}} \end{aligned} \quad (14.91)$$