

**MAUS Analysis User System
User Guide**

Contents

1	What Who and How?	6
1.1	Who Should Use MAUS	6
1.2	Getting the Code and Installing MAUS	6
1.3	Citing MAUS	6
1.4	Running MAUS	6
1.4.1	Run Control	7
1.4.2	Other Applications	7
1.4.3	Choosing the Unpacker Version	8
1.5	Accessing Data	8
1.5.1	Loading ROOT Files in Python Using PyROOT	8
1.5.2	Loading ROOT Files in C++ Compiled Analysis Code	8
1.5.3	Loading ROOT Files on the ROOT Command Line	8
2	Using and Modifying the Data Structure	10
2.1	Metadata	10
2.2	The Spill Datastructure	10
2.3	Image Datastructure	12
2.4	Accessing ROOT files	12
2.5	Conversion to, and Working With, JSON	12
2.6	Extending the Data Structure	13
2.6.1	Pointer Handling	14
3	Introduction to the MAUS API	16
3.1	Motivation	16
3.2	Everything starts with a ‘Module’	16
3.3	Inheritance	16
3.4	Data Mangling	17
3.5	Module Initialisation and Destruction	17
3.6	Global Objects - Objects for Many Modules	17
3.6.1	Global Object Initialisation	17
3.7	Internal Classes	17
3.7.1	Abstraction Layers	18
3.7.2	C++ Python Wrapper	18
3.7.3	Data Mangling	18
4	Utilities	19
4.1	Logging	19
5	Running the Monte Carlo	21
5.1	Beam Generation	21
5.1.1	Beam Polarisation	22
5.1.2	Amplitude Momentum Correlation	22
5.2	Getting the Right Answer	22
5.2.1	Geometry	22
5.2.2	Tracking	22
5.2.3	Energy Deposition and Showering	28
5.3	GEANT4 Bindings	28

6	Geometry	33
6.1	Geometry Access Scripts	33
6.2	Using the Geometry Download Executables	34
6.3	A Little GDML	37
6.3.1	Define	38
6.3.2	Materials	38
6.3.3	Solids	38
6.3.4	Structure	38
6.3.5	Additional Features and Sensitive Detectors	38
6.4	Creation of New Geometries in MAUS	38
7	How to Define a Geometry	40
7.0.1	Configuration File	40
7.0.2	Module Files	41
7.0.3	Volume and Dimensions	42
7.0.4	Properties	42
7.0.5	Child Modules	42
7.0.6	Module Hierarchy and GEANT4 Physical Volumes	43
7.0.7	A Sample Configuration File	43
7.0.8	A Sample Child Module File	44
8	Geometry and Tracking MiceModule Properties	45
8.1	General Properties	45
8.2	Sensitive Detectors	45
8.2.1	Scintillating Fibre Detector (SciFi)	46
8.2.2	Cerenkov Detector (CKOV)	46
8.2.3	Time Of Flight Counter (TOF)	46
8.2.4	Special Virtual Detectors	46
8.2.5	Virtual Detectors	46
8.2.6	Envelope Detectors	47
8.3	Unconventional Volumes	49
8.3.1	Trapezoid Volume	49
8.3.2	Volume Wedge	49
8.3.3	Volume Polycone	49
8.3.4	Volume Quadrupole	49
8.3.5	Volume Multipole	50
8.3.6	Volume Boolean	50
8.3.7	Volume Sphere	51
8.4	Repeating Modules	51
8.5	Beam Definition and Beam Envelopes	51
8.6	Optimiser	54
9	Field Properties	57
9.0.1	FieldType CylindricalField	57
9.0.2	FieldType RectangularField	57
9.0.3	FieldType Solenoid	57
9.0.4	FieldType FieldAmalgamation	58
9.0.5	FieldType DerivativesSolenoid	59
9.0.6	Phasing Models	59
9.0.7	Tracking Stability Around RF Cavities	59
9.0.8	FieldType PillBox	60
9.0.9	FieldType RFFieldMap	60
9.0.10	FieldType Multipole	61
9.0.11	FieldType CombinedFunction	61
9.0.12	EndFieldTypes	62
9.0.13	FieldType MagneticFieldMap	63

10 TOF Detector	65
10.1 Simulation	65
10.1.1 Digitization	65
10.2 Reconstruction	66
10.3 Database	67
11 The Trackers	69
11.1 Introduction	69
11.1.1 Overview	69
11.1.2 Quick start guide	69
11.2 Definitions	70
11.2.1 Labelling of upstream and downstream trackers	70
11.2.2 Station numbering	70
11.2.3 Doublet layer	70
11.2.4 Fibre-channel numbering	72
11.3 Reference surfaces and coordinate systems	72
11.3.1 Doublet layer	72
11.3.2 Station	72
11.3.3 Tracker	72
11.3.4 Coordinate transformations	75
11.4 Reconstruction Algorithms	75
11.4.1 Hits and clusters	75
11.4.2 Space-point reconstruction	77
11.4.3 Pattern recognition	78
11.4.4 Track fit	84
11.5 Data structure	84
11.6 Code Design	84
11.6.1 General Code Structure	84
11.6.2 Tracker configuration variables	88
11.7 The Monte Carlo	88
11.7.1 Station Geometry	89
11.7.2 MC VLPC Dark Count	89
11.7.3 Building Digits	89
12 Global Track Matching	90
12.1 Purpose	90
12.2 Process	90
12.2.1 4th Order Runge-Kutta Propagation	90
12.2.2 TOF1, TOF2, KL	90
12.2.3 TOF0	91
12.2.4 Cherenkov Detectors	91
12.2.5 EMR	91
12.2.6 Upstream-Downstream Matching	91
12.3 Usage	91
12.4 Configuration	91
13 Global PID	93
13.1 Introduction	93
13.1.1 Using the PID scripts	93
13.1.2 Producing PDFs	93
13.2 MapCppGlobalPID and ReduceCppGlobalPID	97
13.2.1 MapCppGlobalPID	97
13.3 ReduceCppGlobalPID	97
13.4 PID Variables	98
13.4.1 PID Base Class	98
13.4.2 PID Variable Classes	98

14	Accessing Global Tracks	101
14.1	The PrimaryChain Object	101
14.1.1	Identifying Decay Candidates	102
14.2	Tracks and Space Points from Local Reconstruction	102
15	The Envelope Tool	103
15.1	Example Usage	103
15.2	Envelope Tool main window	104
15.3	Beam Setup	104
15.4	Magnet Setup	104
15.5	Plot Setup	105
16	G4beamline-MAUS Integration	106
17	Appendix C: Tracker Appendices	108
17.1	Kuno's Conjecture	108
17.2	Space-point variance	108
17.3	Circle parameters from three points	112
17.4	Helical Track Pattern Recognition	113

Chapter 1

What Who and How?

MAUS (MICE Analysis User Software) is the MICE project's tracking, detector reconstruction and accelerator physics analysis framework. MAUS is designed to fulfil a number of functions for physicists interested in studying MICE data:

- Model the behaviour of particles traversing MICE
- Model the MICE detector's electronics response to particles
- Perform pattern recognition to reconstruct particle trajectories from electronics output
- Provide a framework for high level accelerator physics analysis
- Provide online diagnostics during running of MICE

In addition to MAUS's role within MICE, the code is also used for generic accelerator development, in particular for the Neutrino Factory.

1.1 Who Should Use MAUS

MAUS is intended to be used by physicists interested in studying the MICE data. MAUS is designed to function as a general tool for modelling particle accelerators and associated detector systems. The modular system, described in the API section, makes MAUS suitable for use by any accelerator or detector group wishing to perform simulation or reconstruction work.

1.2 Getting the Code and Installing MAUS

Installation is described in a separate document, available at <http://micewww.pp.rl.ac.uk/projects/maus/wiki/Install>

1.3 Citing MAUS

MAUS should be cited according to the guidelines in the file CITATION.

1.4 Running MAUS

MAUS contains several applications to perform various tasks. Two main applications are provided. `bin/simulate_mice.py` makes a Monte Carlo simulation of the experiment and `bin/analyze_data_offline.py` reconstructs an existing data file. Start a clean shell and move into the top level MAUS directory. Then type

```
> source env.sh
> ${MAUS_ROOT_DIR}/bin/simulate_mice.py
> ${MAUS_ROOT_DIR}/bin/analyze_data_offline.py
```

1.4.1 Run Control

The routines can be controlled by a number of settings that enable users to specify run configurations, as specified in this document. Most control variables can be controlled directly from the command line, for example doing

```
> ${MAUS_ROOT_DIR}/bin/simulate_mice.py \  
    --simulation_geometry_filename Test.dat
```

to run the Monte Carlo against a given geometry. As another example, it is possible to run the data reconstruction against a given run

```
> cd ${MAUS_ROOT_DIR}  
> ${MAUS_ROOT_DIR}/bin/analyze_data_offline.py \  
    --daq_data_file 02873 \  
    --daq_data_path src/input/InputCppDAQData
```

This will run against data in run 02873 looking for files in directory `src/input/InputCppDAQData`.

To get a (long) list of all command line variables use the `-h` switch.

```
> ${MAUS_ROOT_DIR}/bin/simulate_mice.py -h
```

More complex control variables can be controlled using a configuration file, which contains a list of configuration options.

```
> ${MAUS_ROOT_DIR}/bin/simulate_mice.py --configuration_file config.py
```

where a sample configuration file for the example above might look like

```
simulation_geometry_filename = "Test.dat"
```

Note that where on the command line a tag like `--variable value` was used, in the configuration file `variable = "value"` is used. In fact the configuration file is a python script. When loaded, MAUS looks for variables in its variable list and loads them in as configuration options. Other variables are ignored. This gives users the full power of a scripting language while setting up run configurations. For example, one might choose to use a different filename,

```
import os  
simulation_geometry_filename = os.path.join(  
    os.environ["MICEFILES"]  
    "Models/Configurations/Test.dat"  
)
```

This configuration will then load the file at `$MICEFILES/Models/Configurations/Test.dat`

The default configuration file can be found at `src/common_py/ConfigurationDefaults.py` which contains a list of all possible configuration variables and is loaded by default by MAUS. Any variables not specified by the user are taken from the configuration defaults.

1.4.2 Other Applications

There are several other applications in the `bin` directory and associated subdirectories.

- `bin/examples` contains example scripts for accessing a number of useful features of the API
- `bin/utilities` contains utility functions that perform a number of useful utilities to do with data manipulation, etc
- `bin/user` contains analysis functions that our users have found useful, but are not necessarily thoroughly tested or documented
- `bin/publications` contains analysis code used for writing a particular (MICE) publication

1.4.3 Choosing the Unpacker Version

The unpacker is the third party library shipped with MAUS used to unpack the MICE DAQ binary data. It comes in two versions, one for Step I data and one for Step IV data. The current default unpacker version is Step IV. In order to switch unpacker versions, set up the MAUS environment, and source (not run) the script `switch_unpacker.bash` in the MAUS root directory supplying either StepI or StepIV as an argument, depending on the unpacker needed. This will then build the correct unpacker, clean and rebuild MAUS, modify `env.sh` and test the new configuration.

1.5 Accessing Data

By default, MAUS writes data as a ROOT file. ROOT is a widely available high energy physics data analysis library, available from '<http://root.cern.ch>' and prepacked with the MAUS third party libraries. Two techniques are foreseen for accessing the data, either using PyROOT python interface or using a compiled C++ binary. Some mention of ROOT cint scripting tools is made below, but this is not supported by MAUS developers beyond the most basic usage.

1.5.1 Loading ROOT Files in Python Using PyROOT

The standard scripting tool in MAUS is python. The ROOT data structure can be loaded in python using the PyROOT package. An example of how to perform a simple analysis with PyROOT is available in `bin/examples/load_root_file.py`. This example runs the reconstruction code to produce an output data file `/${MAUS_ROOT_DIR}/tmp/example_load_root_file.root` and then runs a toy analysis that plots digits at TOF1 for plane 0 and plane 1. This example produces two histograms, `tof1_digits_0_load_root_file.png` and `tof1_digits_1_load_root_file.png`.

1.5.2 Loading ROOT Files in C++ Compiled Analysis Code

The ROOT data structure can be loaded in C++ by compiling the Make file found in `bin/examples/load_root_file_cpp/Makefile`. This compiles the sample analysis in `bin/examples/load_root_file_cpp/load_root_file.cc`. For example,

```
$ source env.sh
$ cd ${MAUS_ROOT_DIR}/bin/examples
$ python load_root_file.py
$ cd ${MAUS_ROOT_DIR}/bin/examples/load_root_file_cpp/
$ make clean
$ make
$ ./load_root_file
```

This example performs a simple analysis against the data file generated by `load_root_file.py`, which is identical to the analysis performed by `load_root_file.py`. The executable produces two histograms, `tof1_digits_0_load_root_file_cpp.png` and `tof1_digits_1_load_root_file_cpp.png`; they should be identical to the histograms produced by `load_root_file.py`.

1.5.3 Loading ROOT Files on the ROOT Command Line

One can load ROOT files from the command line using the ROOT interactive display. It is first necessary to load the MAUS class dictionary. Then The TBrowser ROOT GUI can be used to browse to the desired location and interrogate the data structure interactively. For example,

```
$ source env.sh
$ root

*****
*                                     *
*           W E L C O M E to R O O T           *
*                                     *
*   Version   5.30/03   20 October 2011   *
*                                     *
```



```
*
* You are welcome to visit our Web site *
*      http://root.cern.ch             *
*
*
*****
```

ROOT 5.30/03 (tags/v5-30-03@41540, Oct 24 2011, 11:51:36 on linuxx8664gcc)

CINT/ROOT C/C++ Interpreter version 5.18.00, July 2, 2010

Type ? for help. Commands must be C++ statements.

Enclose multiple statements between { }.

```
root [0] .L $MAUS_ROOT_DIR/build/libMausCpp.so
```

```
root [1] TBrowser b
```

Note: ROOT infrastructure can only be used to plot data nested within up to two dynamic arrays. Data nested in three or more dynamic arrays is beyond the capabilities of ROOT interactive plotting tools; explicit loops over the data are required in a PyROOT script or C++ code. In general, working through the ROOT command line or ROOT macros is notoriously unreliable and is not supported by the MAUS development team; it is useful as a basic check of data integrity and no more.

More information on the data is available in the data structure chapter 2.

Chapter 2

Using and Modifying the Data Structure

MAUS operates on data in discrete blocks, primarily spills, with one spill representing the particle burst generated by one dip of the MICE target. Additionally, MAUS can write data into a JobHeader, RunHeader, RunFooter and JobFooter data type. Histograms for plotting in online mode are encoded into an Image data type. The top level branch in the data tree inherits from MAUSEvent<T>, defined in `src/common_cpp/DataStructure/MAUSEvent.hh` (C++) with type identified by `GetEventType()` string; in JSON the top level branch always has a `maus_event_type` member which is a string value corresponding to the output of `MAUSEvent<T>::GetEventType()`. A summary of configuration cards affecting Input, Output and data structure is shown below.

2.1 Metadata

Job metadata is stored in JobHeader and JobFooter data structures. (Data) Run metadata is stored in RunHeader and RunFooter data structures. The JobHeader is created at the start and end of an execution of the code and stores data on datacards, bsr state and so forth. The RunHeader is created at the start of each run and stores per run metadata such as the calibrations and cabling used. One RunHeader and RunFooter is written for each process in the entire *transform* and *merge* execution structure; so in multithreading mode this would yield one RunHeader and RunFooter for each Celery subprocess (which runs the Input/Transform) and an additional RunHeader and RunFooter for the merge/output process. In single threaded mode a single RunHeader and RunFooter is generated. The RunFooter and JobFooter are created at the end of the run and store run and job summary information. For more details on writing to these metadata types and multithreading modes, please see the section on API.

The Metadata is stored in ROOT in trees separate to the main Spill data tree. In JSON, these data are stored as separate lines often at the start and end of the run, and distinguished by the `maus_event_type` branch in the root. The structure of a MAUS output file is shown below.

2.2 The Spill Datastructure

The major part of the MAUS data structure therefore is a tree of which each entry corresponds to the data associated with one spill. The spill is separated into three main sections: the MCEventArray contains an array of data each member of which represents the Monte Carlo of a single primary particle crossing the system; the ReconEventArray contains an array of data each member of which corresponds to a particle event (i.e. set of DAQ triggers); and the DAQData corresponds to the raw data readout. Additionally there are branches for reconstructed scalars, which are handled spill by spill and EMR data, which also read out on the spill rather than event by event.

The MCEvent is subdivided into sensitive detector hits and some pure Monte Carlo outputs. The primary that led to data being created is held in the Primary branch. Here the random seed, primary position momentum and so forth is stored. Sensitive detector hits have Hit data (energy deposited, position, momentum, etc) and a detector specific ChannelId that represents the channel of the detector that was hit - e.g. for TOF this indexes the slab, plane and station. Virtual hits are also stored - these

Table 2.1: I/O control variables.

Name	Meaning
<code>input_root_file_name</code>	Set the file name used for reading input files by InputCppRoot module
<code>output_root_file_name</code>	Set the file name used for writing output files by OutputCppRoot module
<code>end_of_run_output_root_directory</code>	Set target directory for end of run file placement. The user must ensure that this directory exists or MAUS will throw an exception.
<code>output_root_file_mode</code>	Controls how root files are handled across multiple run numbers. Set to <code>one_big_file</code> to put everything into one big file with file name given by <code>output_root_file_name</code> . Set to <code>one_file_per_run</code> to split the filename by the trailing <code>.</code> and insert the run number, for each run. For example, <code>output.root</code> would become <code>output_999.root</code> for run number 999. Set to <code>end_of_run_file_per_run</code> to place in a directory specified by <code>end_of_run_output_root_directory</code> . Data from each run will be placed in a subdirectory specified by the run number, and a file specified by the <code>output_root_file_name</code> within that directory. MAUS will create the run number directory if one does not exist but not the <code>end_of_run_output_root_directory</code> . So in the example above, if <code>end_of_run_output_root_directory</code> is <code>end_of_run</code> files will be placed like <code>./end_of_run/999/output.root</code>
<code>input_json_file_name</code>	Set the file name used for reading input files by InputPyJSON module
<code>input_json_file_type</code>	Set to <code>gzip</code> to read input from a gzipped file; set to <code>text</code> to read input from a plain text file
<code>output_json_file_name</code>	Set the file name used for writing output files by OutputPyJSON module
<code>output_json_file_type</code>	Set to <code>gzip</code> to write output as a gzipped file; set to <code>text</code> to write output as a plain text file
<code>header_and_footer_mode</code>	Set to <code>append</code> to write out job and run headers and footers; set to <code>dont_append</code> to suppress this output.

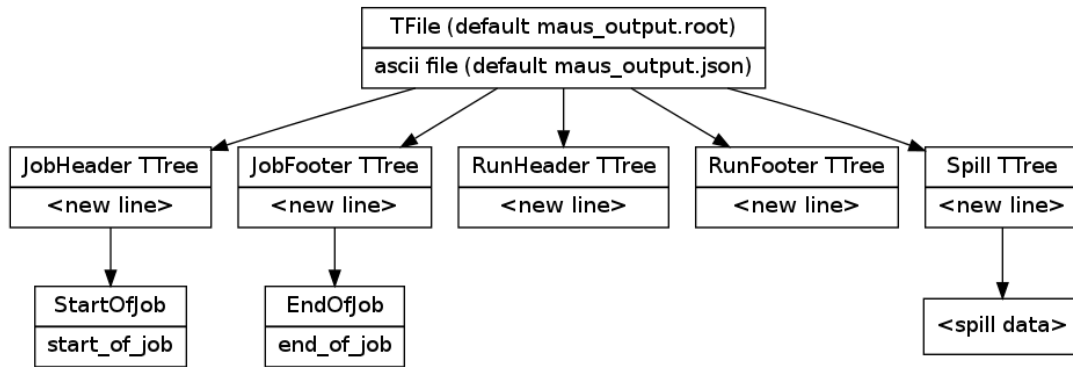

Figure 2.1: The MAUS file structure including metadata. The top label in each box describes the representation in C++/ROOT. The bottom label describes the representation in JSON.

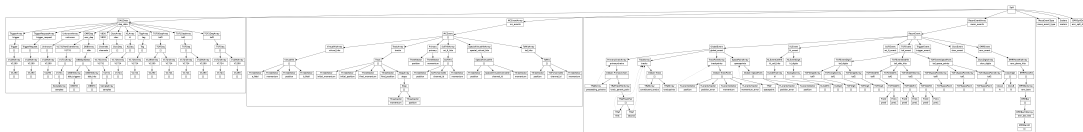

Figure 2.2: The MAUS output structure for a spill event. The top label in each box is the name of the C++ class and the bottom label is the json branch name. If a [] is shown, this indicates that child objects are array items.

are not sensitive detector hits, rather output position, momenta etc of particles that cross a particular plane in space, time or proper time is recorded. Note virtual hits do not inherit from the Hit class and have a slightly different data structure.

The ReconEvent and DAQEvents are subdivided by detector. ReconEvents contain reconstructed particle data for each detector and the trigger. There is an additional branch that contains global reconstruction output, that is the track fitting between detectors.

The data can be written in two formats. The main data format is a ROOT binary format. This requires the ROOT package to read and write, which is a standard analysis/plotting package in High Energy Physics and is installed by the MAUS build script. The secondary data format is JSON. This is an ascii data-tree format that in principle can be read by any text editor. Specific JSON parsers are also available - for example, the python *json* module is available and comes prepackaged with MAUS.

2.3 Image Datastructure

There is a final data type that MAUS handles, the Image type. The Image data structure is written by ReducePyMatplotHistogram and ReducePyROOTHistogram data types. Image data is only available in JSON format. The data structure is shown in Fig. 2.3.

Each document contains a `maus_event_type` that should always be `Image`, and a list of images; the image data is encoded as a base 64 image and other data associated with the image is stored alongside. The `tag` names the image, while `image_type` describes the data format (png, jpeg, etc). `OutputPyImage` stores data with `image_type.tag` as the file name. `description` contains a description of the file and `keywords` describes a list of key phrases that can be used when searching.

2.4 Accessing ROOT files

For details on how to access the ROOT files, please see the introduction section of this document.

2.5 Conversion to, and Working With, JSON

MAUS also provides output in the JSON data format. This is an ascii format with IO libraries available for C++, Python and other languages. Two utilities are provided to perform conversions,

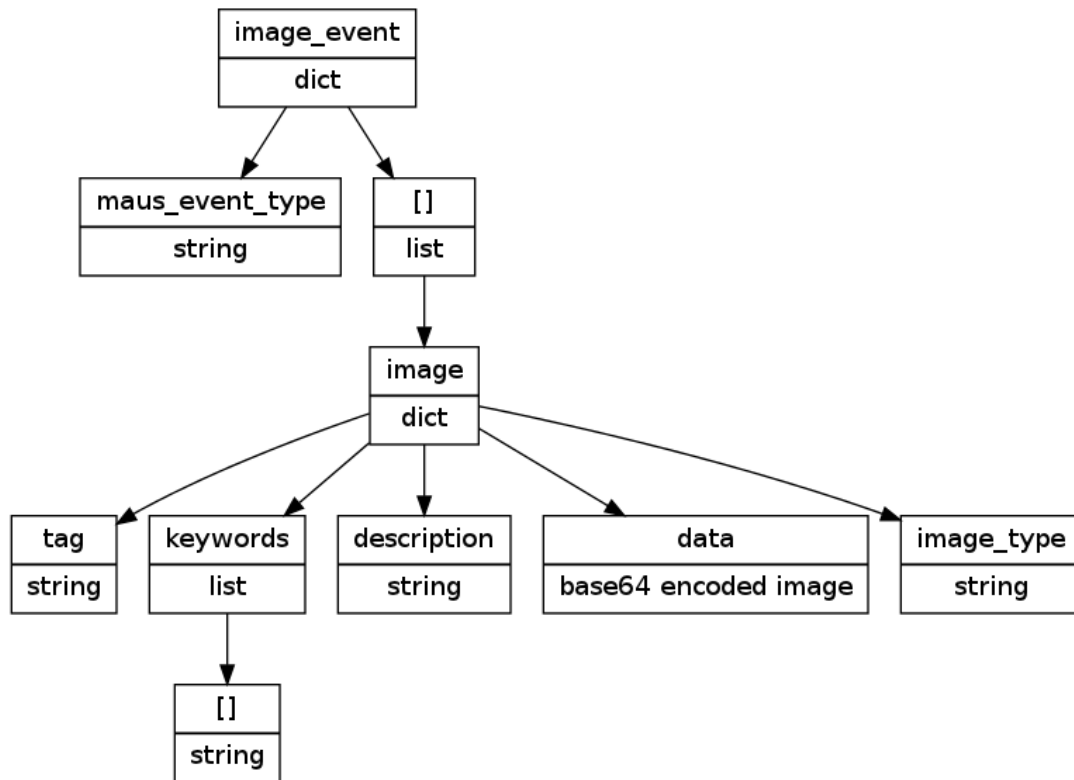

Figure 2.3: The MAUS output structure for an Image event. The top label in each box is the name of the JSON branch and the bottom label is the data type. If a [] is shown, this indicates that child objects are array items. Note there is no C++ implementation of Image events

bin/utilities/json_to_root.py and bin/utilities/root_to_json.py for conversion from and to JSON format respectively. JSON Input and Output modules are provided, InputPyJson and OutputPyJson.

An example json analysis is available in bin/examples/load_json_file.py/

2.6 Extending the Data Structure

The data structure can be extended in MAUS by adding extra classes to the existing data structure. The data classes are in src/common_cpp/DataStructure. In order to make these classes accessible to ROOT, the following steps must be taken:

- Add a new class in src/common_cpp/DataStructure.
- Ensure that default constructor, copy constructor, equality operator and destructor is present. The destructor must be virtual.
- Add #include "src/common_cpp/Uutils/VersionNumber.hh" and a call to the MAUS_VERSIONED_CLASS_DEF() macro at the end of the class definition before the closing braces. MAUS_VERSIONED_CLASS_DEF calls the ROOT ClassDef() macro which generates metaclasses based on information in the class. This is put into the (dynamically generated) MausDataStructure.h,cc files.
- Add the class to the list of classes in src/common_cpp/DataStructure/LinkDef.hh. This is required for the class to be linked properly to the main library, and a linker error will result if this step is not taken.
- Add any template definitions which you used, including STL classes (e.g. std::vector<MyClass> or whatever) to linkdef. Otherwise ROOT will generate a segmentation fault whenever the user tries to call functions of the templated class (but the code will link successfully in this case).

In order to make these classes accessible to JSON, it is necessary to add a new processor in src/common_cpp/JsonCppProcessors. There are a few default processors available.

- `src/common_cpp/JsonCppProcessors/ProcessorBase.hh` contains `IProcessor` pure interface class for all processors and `ProcessorBase` base class (which may contain some implementation)
- `src/common_cpp/JsonCppProcessors/PrimitivesProcessors.hh` contains processors for primitive types; `BoolProcessor`, `IntProcessor`, `UIntProcessor`, `StringProcessor`, `DoubleProcessor`
- `src/common_cpp/JsonCppProcessors/ArrayProcessors.hh` contains processors for array types. Two processors are available: `PointerArrayProcessor` which converts an STL vector of pointers to data; and `ValueArrayProcessor` which converts an STL vector of values to data.
- `src/common_cpp/JsonCppProcessors/ObjectProcessor.hh` contains a processor for object types. Most of the classes in the MAUS data structure are represented in JSON as objects (string value pairs) where each string names a branch and each value contains data, which may be another class.
- `src/common_cpp/JsonCppProcessors/ObjectMapProcessors.hh` contains a processor for converting from JSON objects to STL maps. This is useful for JSON objects that contain lots of branches all of the same type.

A script, `bin/user/json_branch_to_data_structure_and_cpp_processor.py` is available that analyses a JSON object or JSON tree of nested objects and converts to C++ classes. The script is provided "as-is" and it is expected that developers will check the output, adding comments and tests where appropriate.

2.6.1 Pointer Handling

MAUS can handle pointers for arrays and classes using ROOT native support (via the `TRef` and `TRefArray` classes) or the standard JSON reference syntax. JSON references are indexed by a path relative to the root value of a JSON document. JSON references are formatted like URIs, for example the JSON object `{"$ref": "#spill/recon_events/1"}` would index the second `recon_event` in the spill object (indexing from 0). MAUS can only handle paths relative to the top level of the JSON document for the same MAUS event. Absolute URIs, URIs relative to another position in the JSON document or URIs to another MAUS event are not supported.

In MAUS, it is necessary to make a distinction between data that is stored as a value in C++ and JSON (value-as-data), data that is stored as a pointer in C++ and a value in JSON (pointer-as-data) and data that is stored as a pointer in C++ and JSON to some other data in the same tree (pointer-as-reference). In the latter case, the C++ parent object does not own the memory; rather it is owned by some other object in the same tree and *borrowed* by the C++ object holding the pointer-as-reference. The `TRef` and `TRefArray` classes provide this functionality by default; never owning the memory but only storing a relevant pointer. All objects referenced by a `TRef` or `TRefArray` must inherit from `TObject`. ROOT handles all memory management while writing to and reading from ROOT files, and the order of reading is unimportant, as long as both reference and value have been read before the reference is used.

Pointers-as-data are converted between JSON arrays and C++ objects using the `ObjectProcessor<ParentType>::RegisterPointerBranch<ChildType>` method. This takes a `Processor` for the `ChildType` as an argument. For C++ arrays / vectors, the `Processor` argument is instead a `PointerArrayProcessor<ArrayContents>`. Pointers-as-reference (`TRef` and `TRefArray`) are converted using the `ObjectProcessor<ParentType>::RegisterTRef` and `ObjectProcessor<ParentType>::RegisterTRefArray` methods respectively.

Other equivalent data formats, for example YAML, use a unique identifier to reference a pointer-as-reference and store the pointer-as-data in a reserved part of the data tree. There are some consequences of storing pointers-as-reference using the path to a pointer-as-data as implemented in MAUS.

- The user must specify which data is the primary data source (pointer-as-data) and which data is a cross reference (pointer-as-reference).
- Pointers-as-reference are position dependent. If the associated pointer-as-data is moved the pointer-as-reference can no longer be resolved. For example, inserting an element into an array can cause misalignment of pointers-as-reference.
- Pointer data will always be available at the location of the pointer-as-data in the JSON tree, even when using a parser that is not pointer aware.

- A unique identifier type algorithm can be implemented as a relatively simple extension of the data format outlined here; but it is relatively hard to extend a unique identifier algorithm to reference existing parts of the data tree.

Pointer Resolution

Conversion from C++ pointers to JSON pointers is handled in a type-safe way. Values-as-data are stored in the data tree converted at run time from JSON to C++ and vice versa. Pointers-as-data are handled in the same way as Values-as-data. Pointers-as-references are stored in the C++ data tree as a TRef (or TRefArray element) in the normal way, and in JSON as an address to the position in the tree to a pointer-as-data. It is an error to store a pointer-as-reference without storing an associated pointer-as-data as the pointer-as-reference cannot be converted, unless the pointer-as-reference is set to NULL (in which case it may be an error depending on caller settings). It is an error to store multiple C++ pointers-as-data to the same memory address as the conversion from C++ to JSON and back again would yield logically different data and the resolution of associated pointers-as-reference is dependent on the resolution order of the data tree, which is ill-defined.

In order to implement the data conversion, the pointers have to be resolved in a two-stage process. In the first stage, it is necessary to collect all of the pointers-as-data and pointers-as-reference by traversing the data tree. This is performed during the standard data conversion, but pointers-as-reference are left pointing to NULL. A mapping from the pointer-as-data in the original data format to the pointer-as-data in the converted data format is stored, together with a list of pointers-as-reference in the original data format and the necessary mutators in the converted data format. In the second stage MAUS iterates over the pointers-as-reference, finds the appropriate pointer-as-data and writes the location of the pointer-as-data to the pointer-as-reference in the converted data format. The code is templated to maintain full type-safety during this process.

Chapter 3

Introduction to the MAUS API

This chapter introduces the MAUS API framework and looks in depth at the structure of the classes and interfaces that it comprises of. Several example *minimal* implementations are given before a note on scalability and extending the framework.

3.1 Motivation

The MAUS API framework provides MAUS developers with a well-defined environment for developing reconstruction code, while allowing independent development of the backend and code sharing of common elements like error handling and data mangling.

3.2 Everything starts with a ‘Module’

An *Module* is the basic building block of the MAUS API framework. Four types of module exist within MAUS.

- An Input module is used to create an instance of a MAUS Spill structure.
- An Output module is used to store an instance of a MAUS data structure.
- A Map module is used to modify a single Spill item. This enables the reconstruction to be parallelised across multiple Maps.
- A Reduce module is used to act on a collection of Spills.

Every module has a constructor, destructor, a birth and a death method. Input modules have an emitter function that yields a new data object. Output modules have a save function that takes a data object and stores it (either on disk, or for example broadcasting across a socket).

Map modules and Reduce modules have a process function that takes a data object and modifies it. The important difference is that Map modules have no internal state, meaning that they can be run in parallel. Reduce modules, on the other hand, do have internal state. This means that they can act on groups of Spills, for example collecting histogram data.

3.3 Inheritance

In order to correctly make a module, one should inherit from the correct type.

- Input modules should inherit from `InputBase`.
- Output modules should inherit from `OutputBase`.
- Map modules should inherit from `MapBase`.
- Reduce modules should inherit from `ReduceBase`.

Base types are defined in `src/common_cpp/API` for C++ modules and `src/common_py/API` for python modules.

3.4 Data Mangling

MAUS supports representation of the data structure in various different formats. MAUS support representation in ROOT, ascii string and json formats. It is recommended that reconstruction routines use the ROOT format. For legacy reasons, MAUS supports reconstruction of data stored in ascii or json formats.

In python, the representation (i.e. format) of the data can be changed by using the module `maus_cpp.converter`. If a module implements conversion to a specific data type, the `can_convert` flag should be set to `True`; otherwise MAUS will always hand data in string format.

In C++, mappers are templated to a MAUS data type. The API then handles any necessary conversion to that data type, and provides the appropriate python wrapper code for that module.

Currently only map modules support data mangling.

3.5 Module Initialisation and Destruction

MAUS has two execution concepts. A `Job` refers to a single execution of the code, while a `Run` refers to the processing of data for a MICE data run or Monte Carlo run.

In MAUS, Inputters, Mappers, Reducers and Outputters are initialised at the start of every `Job` and destructed at the end of every `Job`. `birth(...)` for Inputters and Outputters is called at the start of every `Job` and `death()` is called at the end of every `Job`. The `birth(...)` for Mappers and Reducers is called at the start of every `Run` and `death()` is called at the end of every `Run`.

The logic is that for each code execution we typically want to access data from a single data source and output data to a single data file. But mappers and reducers are reinitialised for each run to enable loading of new calibrations, etc. It is required that all transient information about the reconstruction pertaining to a run - particularly ID of the calibration and cabling used - is recorded in the `StartOfRun` data structure. Any summary information on code execution during the run may be stored in the `EndOfRun` data structure. All transient information pertaining to a job - for example code version or bzt branch - should be recorded in the `StartOfJob` data structure. Any summary information on code execution during the job may be stored in the `EndOfJob` data structure.

3.6 Global Objects - Objects for Many Modules

There are some objects that sit outside the scope of the modular framework described above. Typically these are objects that do not belong to any one module, but need to be accessed by many. Examples are the logging functionality (Squeak), ErrorHandler, Configuration datacards, field maps, geometry description and Geant4 interfaces. These are accessed through the static singleton class `Globals` defined in `src/common_cpp/Utils/Globals.hh`. Initialisation is handled in `src/common_cpp/Globals/GlobalsManager.hh`. One `Globals` instance is initialised per subprocess when running in multiprocessing mode.

For python users, some Global objects can be accessed by reference to the `maus_cpp.globals` module.

3.6.1 Global Object Initialisation

Global objects are initialised before any modules in `Go.py` and deleted after all modules are deleted. Global object initialisation and destruction is handled at the `Job` level by `src/common_cpp/Globals/GlobalManager.hh` and called in python via `maus_cpp.globals` as above.

Run-by-run initialisation is handled by the `RunActionManager`, defined in `src/common_cpp/Utils/RunActionManager.hh`. The `RunActionManager` holds a list of objects inheriting from `RunActionBase` each of which defines functions to call at the start and end of each run.

3.7 Internal Classes

The following classes and namespaces are used to provide an interface between reconstruction modules and the framework (backend).

3.7.1 Abstraction Layers

These are all defined in `src/common_cpp/API` and `src/common_py/API` folders

- `IModule` - interface class for all modules; defines `birth` and `death`
- `ModuleBase` - base class for modules, includes some error handling.
- `IInput` - interface class for all inputs; defines `emitter` and inherits from `IModule`
- `InputBase` - base class for all inputs, includes some error handling and inherits from `ModuleBase` and `IInput`
- `IMap` - interface class for all inputs; defines `process` and inherits from `IModule`
- `MapBase` - base class for all inputs, includes some error handling and inherits from `ModuleBase` and `IMap`
- `IReduce` - interface class for all reducers; defines `process` and inherits from `IModule`
- `ReduceBase` - base class for all reducers, includes some error handling and inherits from `ModuleBase` and `IReduce`
- `IOutput` - interface class for all outputs; defines `save` and inherits from `IModule`
- `OutputBase` - base class for all outputs, includes some error handling and inherits from `ModuleBase` and `IOutput`

3.7.2 C++ Python Wrapper

`src/common_cpp/API/PyWrapMapBase` is a templated class that wraps a generic map object and provides python interfaces to that map object.

Currently, Input, Reduce, Output wrappers are provided by SWIG.

3.7.3 Data Mangling

Data mangling is handled in a variety of layers.

- `src/common_cpp/Converter/ConverterBase` provides an abstraction for conversion from one type to another
- `src/common_cpp/Converter/DataConverters` provides implementations of the data conversions
- `src/common_cpp/Converter/ConverterFactory` provides a function like `TYPE2* convert<TYPE1, TYPE2>(TYPE1* data)` with implementations for each of the types. This then provides explicit conversion (i.e. where both input and output types are known).
- `src/common_cpp/Utils/PyObjectWrapper` provides functions for wrapping all of the data types into a `PyObject*`. It also provides a function that unwraps the `PyObject*`, figures out the data type and returns a data of the appropriate type.
- `src/common_cpp/API/PyWrapMapBase` calls `unwrap` based on the type stored in the `PyObject*`.

Chapter 4

Utilities

This chapter describes the various utilities present in MAUS, such as the built-in logger.

4.1 Logging

The MAUS logging system is built around the Squeak class. The code for the Squeak class is located in `src/common_cpp/Utils`. It is implemented as a singleton class, designed to wrap the standard output, log and error streams (`cout`, `clog`, `cerr`). In addition to this the ability to output to a standard log file is present.

The key interface point with the class for the user is the `mout` method, which takes an “error level” as an argument and returns an output stream which may be streamed to. The error levels themselves are defined in an enum and may take the values described in table 4.1.

Name	Value	Default stream
debug	0	cout
info	1	clog
warning	2	cerr
error	3	cerr
fatal	4	cerr
log	5	file

Table 4.1: The MAUS logging error levels.

Prior to use Squeak must be configured by calling the following methods:

```
Squeak::setStandardOutputs(verbose_level);  
Squeak::setOutputs(verbose_level, log_level);
```

where both `verbose_level` and `log_level` are integers. The first function configures whether `cout`, `clog` and `cerr` point to the screen, the log file or `/dev/null`. If the verbose level supplied is 0 everything goes to screen, 1 `clog` and `cerr` only go to screen, 2 and 3 only `cerr` goes to screen, >3 none go to screen.

The second function controls where different `mout` error levels go. If the verbosity level supplied is less than or equal to the enum value (defined in table 4.1) of the particular error level then that value goes to screen. The exception to this is `log` which may only go to file. If an error level does not go to screen then it goes to either `/dev/null` or the log file, depending on the log level.

The log level defines what data is sent to the log file. When set to 0 no log file is created, streams to `Squeak::log` are thrown away, together with all other error levels not going to screen. When set to 1 a log file is created which records only explicit calls to `Squeak::log`. When set to 2 a log file is again created which captures calls to `Squeak::log` and any other error level which does not make it to screen.

Both the verbose and log level may be set via datacards using the variables `verbose_level` and `log_level` (set to 1 and 0 respectively by default). The log file name defaults to “`maus.log`”. It may be changed using the method:

```
Squeak::setLogName("some_name.log")
```

This must be called prior to the log file being initialised with the `setOutputs` method. If logging has been used the file must be closed prior to programme termination with:

```
Squeak::closeLog();
```

When running as part of standard MAUS execution both Squeal initialisation and closing the log are taken care of by the `GlobalsManager` and the user need do nothing.

An example use of Squeal to send text to standard output:

```
Squeal::mout(Squeal::debug) << "A message" << std::endl;
```

A short example programme illustrating use of Squeal is present in `bin/user/examples/logging/`.

Chapter 5

Running the Monte Carlo

The simulation module provides particle generation routines, GEANT4 bindings to track particles through the geometry and routines to convert modelled energy loss in detectors into digitised signals from the MICE DAQ. The Digitisation models are documented under each detector. Here we describe the beam generation and GEANT4 interface.

5.1 Beam Generation

Beam generation is handled by the MapPyBeamMaker module. Beam generation is separated into two classes. The MapPyBeamGenerator has routines to assign particles to a number of individual beam classes, each of which samples particle data from a predefined parent distribution. Beam generation is handled by the `beam` datacard.

The MapPyBeamMaker can either take particles from an external file, overwrite existing particles in the spill, add a specified number of particles from each beam definition, or sample particles from a binomial distribution. The random seed is controlled at the top level and different algorithms can be selected influencing how this is used to generate random seeds on each particle.

Each beam definition has routines for sampling from a multivariate gaussian distribution or generating ensembles of identical particles (called "pencil" beams here). Additionally it is possible to produce time distributions that are either rectangular or triangular in time to give a simplistic representation of the MICE time distribution.

The beam definition controls are split into four parts. The `reference` branch defines the centroid of the distribution; the `transverse` branch defines the transverse coordinates, x, y, px, py ; the `longitudinal` branch defines the longitudinal coordinates - time and energy/momentum and the `coupling` branch defines correlations between longitudinal and transverse. Additionally a couple of parameters are available to control random seed generation and relative weighting between different beam definitions.

In transverse, beams are typically sampled from a multivariate gaussian. The Twiss beam ellipse is defined by

$$\mathbf{B}_\perp = m \begin{pmatrix} \epsilon_x \beta_x / p & -\epsilon_x \alpha_x & 0 & 0 \\ -\epsilon_x \alpha_x & \epsilon_x \gamma_x p & 0 & 0 \\ 0 & 0 & \epsilon_y \beta_y / p & -\epsilon_y \alpha_y \\ 0 & 0 & -\epsilon_y \alpha_y & \epsilon_y \gamma_y p \end{pmatrix} \quad (5.1)$$

The Penn beam ellipse is defined by,

$$\mathbf{B}_\perp = m \epsilon_\perp \begin{pmatrix} \beta_\perp / p & -\alpha_\perp & 0 & -\mathcal{L} + \beta_\perp B_0 / 2p \\ -\alpha_\perp & \gamma_\perp p & \mathcal{L} - \beta_\perp B_0 / 2p & 0 \\ 0 & \mathcal{L} - \beta_\perp B_0 / 2p & \beta_\perp / p & -\alpha_\perp \\ -\mathcal{L} + \beta_\perp B_0 / 2p & 0 & -\alpha_\perp & \gamma_\perp p \end{pmatrix} \quad (5.2)$$

where parameters can be controlled in datacards as described below. Note that using the datacards it is possible to define a beam ellipse that is poorly conditioned (determinant nearly zero). In this case MAUS will print an error message like `Warning: invalid value encountered in double_scalars` for each primary.

5.1.1 Beam Polarisation

It is also possible to pass a polarised beam through MAUS. A polarised beam can be generated using the `beam_polarisation` variable on an individual beam parameter. Currently only one polarisation model has been implemented, `gaussian_unit_vectors`. This throws a Gaussian in each of the x, y and z directions and uses this to generate a spin vector. The spin vector is then normalised to 1. Correlations are not implemented.

5.1.2 Amplitude Momentum Correlation

It is possible to introduce artificially a correlation between transverse amplitude (action) and momentum. This can be of use for high emittance beams, such as those in MICE, where the time of flight of high amplitude particles is significantly different to the time of flight of low amplitude particles. The optional `a-p_correlation` dict enables one to specify a correlation C (see table 5.8). In this case, the momentum_variable W_o is modified according to

$$W_o = W_i(1 + CA). \quad (5.3)$$

W_i is the momentum_variable as calculated by the longitudinal routines above, C is the correlation magnitude and amplitude A is calculated using

$$A = |\mathbf{V}|^{1/4} m^2 (u^T \mathbf{V}^{-1} \vec{u}) \quad (5.4)$$

where \vec{u} is the particle phase space vector, m is the particle mass and \mathbf{V} is the ideal beam matrix defined by the `transverse` dict.

5.2 Getting the Right Answer

In MICE, the code is required to get the right answer for a number of difference use cases. MICE needs accurate stepping through the complex field maps, correct energy loss and scattering in the emittance absorbers and diffuser and accurate energy deposition in the sensitive detectors and correct showering especially in the downstream detectors. The *Right Answer* in this case is the one that agrees with experiment.

5.2.1 Geometry

There are copious comments on setting up your own geometry in the relevant chapter. I only remark here that you should

- Visualise the geometry.
- Set `verbose_level` to 1 so that MAUS reports the field configuration in it's output file.
- Check the field maps using e.g. `bin/examples/make_field_map.py`.
- Set `check_volume_overlaps` to `True` to call Geant4 internal checks for geometry consistency.

Otherwise it is highly unlikely that you will get the correct geometry.

5.2.2 Tracking

The principle tool that can be used to ensure a correct answer from tracking through the field maps is the step size. This is controlled either from MiceModules by setting the `G4StepMax` parameter per volume; or from data cards by setting the `max_step_length` parameter. Setting this parameter to a small value increases the tracking time; setting it to a large value decreases the accuracy. Numerically, 100 mm is found to be a reasonable value for sufficiently accurate stepping through the fields [citation: C Rogers thesis]. No one has ever studied effect of miss distance on e.g. some of the MICE apertures.

It is also wise to avoid hard field edge boundaries in the cooling channel. MAUS uses by default 4th order Runge Kutta for numerical integration (RK4, `stepping_algorithm = "ClassicalRK4"`). For each tracking step, RK4 calls the MAUS field map routines 4 times. Geant4/RK4 only knows about the field value at these four points, and makes some smoothing approximation at intermediate points.

Table 5.1: Control parameters pertaining to all beam definitions.

Name	Meaning
<code>beam</code>	dict containing beam definition parameters.
<i>The following cards should all be defined within the <code>beam</code> dict.</i>	
<code>particle_generator</code>	Set to <code>binomial</code> to choose the number of particles by sampling from a binomial distribution. Set to <code>counter</code> to choose the number of particles in each beam definition explicitly. Set to <code>file</code> to generate particles by reading an input file. Set to <code>overwrite_existing</code> to generate particles by overwriting existing primaries.
<code>binomial_n</code>	When using a binomial <code>particle_generator</code> , this controls the number of trials to make. Otherwise ignored.
<code>binomial_p</code>	When using a binomial <code>particle_generator</code> , this controls the probability a trial yields a particle. Otherwise ignored.
<code>beam_file_format</code>	When using a file <code>particle_generator</code> , set the input file format - options are <ul style="list-style-type: none"> • <code>icool_for009</code> • <code>icool_for003</code>, • <code>g4beamline_bl_track_file</code> • <code>g4mice_special_hit</code> • <code>g4mice_virtual_hit</code> • <code>mars_1</code> • <code>maus_virtual_hit</code> • <code>maus_primary</code>
<code>beam_file</code>	When using a file <code>particle_generator</code> , set the input file name. Environment variables are automatically expanded by MAUS.
<code>file_particles_per_spill</code>	When using a file <code>particle_generator</code> , this controls the number of particles per spill that will be read from the file.
<code>random_seed</code>	Set the random seed, which is used to generate individual random seeds for each primary (see below).
<code>definitions</code>	A list of dicts, each item of which is a dict defining the distribution from which to sample individual particles.

Table 5.2: Individual beam distribution parameters.

Name	Meaning
<i>The following cards should be inside a dict in the beam definitions list.</i>	
random_seed_algorithm	Choose from the following options <ul style="list-style-type: none"> • beam_seed: use the random_seed for all particles • random: use a different randomly determined seed for each particle • incrementing: use the random_seed but increment by one each time a new particle is generated • incrementing_random: determine a seed at random before any particles are generated; increment this by one each time a new particle is generated
weight	When particle_generator is binomial or overwrite_existing , the probability that a particle will be sampled from this distribution is given by $weight/(sum\ of\ weights)$.
n_particles_per_spill	When particle_generator is counter , this sets the number of particles that will be generated in each spill.
reference	Dict containing the reference particle definition.
transverse	Dict defining the longitudinal phase space distribution.
longitudinal	Dict defining the longitudinal phase space distribution.
coupling	Dict defining any correlations between transverse and longitudinal.
beam_polarisation	Optional dict defining the polarisation of the beam. If this dict is not included, the beam is taken to be unpolarised.
a-p_correlation	Optional dict that defines a correlation between transverse amplitude and longitudinal momentum. If this dict is not included, no such correlation is introduced.

Table 5.3: Beam distribution reference definition.

Name	Meaning
<i>The following cards should be defined in each beam definition reference dict.</i>	
position	dict with elements x , y and z that define the reference position (mm).
momentum	dict with elements x , y and z that define the reference momentum direction. Normalised to 1 at runtime.
particle_id	PDG particle ID of the reference particle.
energy	Reference energy.
time	Reference time (ns).
random_seed	Set to 0 - this parameter is ignored.

Table 5.4: Beam definition transverse parameters.

Name	Meaning
<i>The following cards should be defined in each beam definition transverse dict.</i>	
transverse_mode	Options are <ul style="list-style-type: none"> • pencil: x, px, y, py taken from reference • uniform: Radius and p_t randomly selected from uniform distribution for testing and systematic studies. • penn: cylindrical beam symmetric in x and y • constant_solenoid: cylindrical beam symmetric in x and y, with beam radius calculated from on-axis B-field to give constant beam radius along a solenoid. • twiss: beam with decoupled x and y beam ellipses.
normalised_angular_momentum	if transverse_mode is penn or constant_solenoid, set \mathcal{L} .
emittance_4d	if transverse_mode is penn or constant_solenoid, set ϵ_{\perp} .
beta_4d	if transverse_mode is penn, set β_{\perp} .
alpha_4d	if transverse_mode is penn, set α_{\perp} .
bz	if transverse_mode is constant_solenoid, set the B-field used to calculate β_{\perp} and α_{\perp} .
beta_x	if transverse_mode is twiss, set β_x .
alpha_x	if transverse_mode is twiss, set α_x .
emittance_x	if transverse_mode is twiss, set ϵ_x .
beta_y	if transverse_mode is twiss, set β_y .
alpha_y	if transverse_mode is twiss, set α_y .
emittance_y	if transverse_mode is twiss, set ϵ_y .
range_radius	if transverse_mode is uniform, set the radial extent of the beam.
range_pt	if transverse_mode is uniform, set the range of transverse momenta.
fit_solenoid	if transverse_mode is uniform, specify the magnetic into which the beam is being simulation. It ignores range_radius and sets the x and y values such that the particles do no rotate outside their initial radius due to the larmor rotations.

Table 5.5: Beam definition longitudinal parameters.

Name	Meaning
<i>The following cards should be defined in each beam definition longitudinal dict.</i>	
momentum_variable	In all modes, set this variable to control which longitudinal variable will be used to control the input beam. Options are <code>energy</code> , <code>p</code> , <code>pz</code> .
longitudinal_mode	Options are <ul style="list-style-type: none"> • <code>pencil</code>: time, energy/p/pz taken from <code>reference</code> • <code>gaussian</code>: uncorrelated gaussians in time and energy/p/pz • <code>twiss</code>: multivariate gaussian in time and energy/p/pz • <code>uniform</code>: uniform in energy/p/pz and time taken from reference. • <code>uniform_time</code>: gaussian in energy/p/pz and uniform in time. • <code>sawtooth_time</code>: gaussian in energy/p/pz and sawtooth in time.
beta_l	In Twiss mode, set β_l
alpha_l	In Twiss mode, set α_l
emittance_l	In Twiss mode, set ϵ_l
sigma_t	In gaussian mode, set the RMS time.
sigma_p	In gaussian, uniform_time, sawtooth_time mode, set the RMS energy/p/pz.
sigma_energy	
sigma_pz	
cov(t,p)	In gaussian mode, set the covariance between p/energy/pz and time and energy. It is an error if this results in a matrix that is not positive definite (eigenvalues positive).
cov(t,energy)	
cov(t,pz)	
range_p	In uniform mode, set the window of momenta that can be sample from from, like: <code>[100.0, 300.0]</code>
t_start	In uniform_time and sawtooth_time mode, set the start time of the parent distribution
t_end	In uniform_time and sawtooth_time mode, set the end time of the parent distribution

Table 5.6: Beam definition coupling parameters.

Name	Meaning
<i>The following cards should be defined in each beam definition coupling dict.</i>	
coupling_mode	Set to <code>none</code> - not implemented yet.

Table 5.7: Beam definition polarisation.

Name	Meaning
<i>The following cards should be defined in each beam definition <code>beam_polarisation</code> dict.</i>	
<code>polarisation_mode</code>	If set to <code>flat</code> , the beam is taken as unpolarised. If set to <code>gaussian_unit_vectors</code> , spin vector is given by a gaussian distribution in x, y, z; the spin vector is then normalised to 1 before tracking.
<code>beam_mean_x</code>	If <code>beam_polarisation</code> is set to <code>gaussian_unit_vectors</code> , the mean x value of the gaussian.
<code>beam_sigma_x</code>	If <code>beam_polarisation</code> is set to <code>gaussian_unit_vectors</code> , the sigma x value of the gaussian.
<code>beam_mean_y</code>	If <code>beam_polarisation</code> is set to <code>gaussian_unit_vectors</code> , the mean y value of the gaussian.
<code>beam_sigma_y</code>	If <code>beam_polarisation</code> is set to <code>gaussian_unit_vectors</code> , the sigma y value of the gaussian.
<code>beam_mean_z</code>	If <code>beam_polarisation</code> is set to <code>gaussian_unit_vectors</code> , the mean z value of the gaussian.
<code>beam_sigma_z</code>	If <code>beam_polarisation</code> is set to <code>gaussian_unit_vectors</code> , the sigma z value of the gaussian.

Table 5.8: Beam definition amplitude-momentum correlation.

Name	Meaning
<i>The following cards should be defined in each beam definition <code>a-p_correlation</code> dict.</i>	
<code>magnitude</code>	The magnitude of the amplitude-momentum correlation.
<code>momentum_variable</code>	Optional parameter to specify the momentum variable W. Options are <code>energy</code> , <code>p</code> , <code>pz</code> . If not specified, defaults to <code>momentum_variable</code> from <code>longitudinal</code> dict.

If the geometry presents a field inhomogeneity i.e. a hard edged boundary, it will severely degrade the stability of the tracking. The way to fix this is to implement Geant4 volume boundaries on either side of the edge of any field maps. This forces Geant4 to stop tracking, step over the field boundary, and then start tracking again.

5.2.3 Energy Deposition and Showering

There are a couple of other considerations for handling energy deposition, decays and so forth. `physics_model` is the master control variable, which tells Geant4 which physics model to use. The Geant4 mindset is that Geant4 provides a library of physics processes, and that the defaults are not necessarily correct for all use cases. This is different to e.g. MARS or equivalent tools. Rogers has selected QGSP_BERT as a reasonable default, following recommendation from G4Beamline developers.

The MICE beam is quite highly polarised. Polarised decay is possible to do in MAUS (`polarised_decay` and `spin_tracking`), but it is poorly understood experimentally so it is not active by default. Be aware that probably electron background estimation is wrong in MICE/MAUS.

If the physics you wish to study includes showering effects, check that you are happy with the `kinetic_energy_threshold`, `production_threshold` and `fine_grained_production_threshold` parameters. The `kinetic_energy_threshold` sets the minimum energy of particles that will be tracked and the `production_threshold` parameters control the minimum range of particles that will be produced.

The `fine_grained_production_threshold` sets the geant4 production threshold per particle and per region. Regions are defined using the MiceModule `Region` string property, which can map several volumes to the same region. `fine_grained_production_threshold` should be a dictionary that maps the string name of a region to another dictionary. This dictionary should map the string name or pdg encoded integer id in string format to the production threshold. For example, the entry in the datacards file might look like

```
fine_grained_production_threshold = {
    "my_region":{
        "e+":0.1,
        "11":0.01,
        "22":-1
    }
}
```

which would set production thresholds for all MiceModules in `my_region` to 0.1 mm for positrons, 0.01 mm for electrons, and use the Geant4 defaults for gammas. All other particles would take their production threshold defaults from `production_threshold` datacard.

5.3 GEANT4 Bindings

The GEANT4 bindings are encoded in the Simulation module. GEANT4 groups particles by run, event and track. A GEANT4 run maps to a MICE spill; a GEANT4 event maps to a single inbound particle from the beamline; and a GEANT4 track corresponds to a single particle in the experiment.

A number of classes are provided for basic initialisation of GEANT4.

- `MAUSGeant4Manager`: is responsible for handling interface to GEANT4. `MAUSGeant4Manager` handles initialisation of the GEANT4 bindings as well as accessors for individual GEANT4 objects (see below). Interfaces are provided to run one or many particles through the geometry, returning the relevant event data. The `MAUSGeant4Manager` sets and clears the event action before each run.
- `MAUSPhysicsList`: contains routines to set up the GEANT4 physical processes. Datacards settings are provided to disable stochastic processes or all processes and set a few parameters. In the end, the physics list set up gets called by the `FieldPhaser`.
- `FieldPhaser`: the field phaser is a MAUS-specific tool for automatically phasing fields, for example RF cavities, such that they ramp coincidentally with incoming particles. The `FieldPhaser` contains routines to fire test ("reference") particles through the accelerator lattice and phase fields appropriately. The `FieldPhaser` phasing routines are called after GEANT4 is first initialised.

- **DetectorConstruction:** the `DetectorConstruction` routines provide an interface between the MAUS internal geometry representation encoded in `MiceModules` and `GEANT4`. `DetectorConstruction` is responsible for calling the relevant routines for setting up the general engineering geometry, calling detector-specific geometry set-up routines and calling the field map set-up routines.
- **VirtualPlanes:** the `VirtualPlanes` routines are designed to extract particle data from the `GEANT4` tracking independently of the `GEANT4` geometry. The `VirtualPlanes` routines watches for steps that step across some plane in physical space, or some time, or some proper time, and then interpolates from the step ends to the plane in question.
- **FillMaterials:** (legacy) the `FillMaterials` routines are used to initialise a number of specific
- **MAUSVisManager** the `MAUSVisManager` is responsible for handling interfaces with the `GEANT4` visualisation.

The `GEANT4 Action` objects provide interfaces for MAUS-specific function calls at certain points in the tracking.

- **MAUSRunAction:** sets up the running for a particular spill. In MAUS, it just reinitialises the visualisation.
- **MAUSEventAction:** sets up the running for a particular inbound particle. At the beginning of each event, the virtual planes, tracking, detectors and stepping are all cleared. After the event the event data is pulled into the event data from each element.
- **MAUSTrackingAction:** is called when a new track is created or destroyed. If `keep_tracks` datacard is set to `True`, on particle creation, `MAUSTrackingAction` writes the initial and final track position and momentum to the output data tree. If `keep_steps` is set to `True` `MAUSTrackingAction` gets step data from `MAUSSteppingAction` and writes this also.
- **MAUSSteppingAction:** is called at each step of the particle. If `keep_steps` datacard is set to `True`, output step data is recorded. `MAUSSteppingAction` kills particles if they exceed the `maximum_number_of_steps` datacard. `MAUSSteppingAction` calls the `VirtualPlanes` routines on each step.
- **MAUSStackingAction:** is called when a new track is created, prioritising particle tracking. Handles killing particles based on the `kinetic_energy_threshold`, `default_keep_or_kill` and `keep_or_kill_particles` datacards.
- **MAUSPrimaryGeneratorAction:** is called at the start of every event and sets the particle data for each event. In MAUS, this particle generation is handled externally and so the `MAUSPrimaryGeneratorAction` role is to look for the primary object on the Monte Carlo event and convert this into a `GEANT4` event object.

Table 5.9: Monte Carlo control parameters.

Name	Meaning
<i>General Monte Carlo controls.</i>	
<code>simulation_geometry_filename</code>	Filename for the simulation geometry - searches first in files tagged by environment variable <code>#{MICEFILES}</code> , then in the local directory.
<code>simulation_reference_particle</code>	Reference particle used for phasing fields. The format is as defined for a reference entry in a beam.
<code>keep_tracks</code>	Set to boolean true to store the initial and final position/momentum of each track generated by MAUS.
<code>keep_steps</code>	Set to boolean true to store every step generated by MAUS - warning this can lead to large output files.
<code>check_volume_overlaps</code>	Set to a boolean value. Check for overlaps in volumes. If an overlap is detected, Geant4 will report a warning and then quit.
<code>everything_special_virtual</code>	Set to a boolean value. If true, all volumes will be made special virtual and record e.g. energy deposited.

Table 5.10: Tracking control parameters.

<i>Tracking control parameters.</i>	
<code>max_step_length</code>	Default maximum step size during tracking. Override with <code>G4StepMax</code> in <code>MiceModule</code> .
<code>max_track_time</code>	Kill tracks with time above this time. Override with <code>G4TimeMax</code> in <code>MiceModule</code> .
<code>max_track_length</code>	Kill tracks with track length above this length. Override with <code>G4TrackMax</code> in <code>MiceModule</code> .
<code>maximum_number_of_steps</code>	Set to an integer value. Tracks taking more steps are assumed to be looping and are killed.
<code>kinetic_energy_threshold</code>	Kill tracks with initial kinetic energy below this threshold. Override with <code>G4KinMin</code> in <code>MiceModule</code> .
<code>field_tracker_absolute_error</code>	Set absolute error on MAUS internal stepping routines - used by e.g. <code>VirtualPlanes</code> to control accuracy of interpolation.
<code>field_tracker_relative_error</code>	Set relative error on MAUS internal stepping routines - used by e.g. <code>VirtualPlanes</code> to control accuracy of interpolation.
<code>stepping_algorithm</code>	String to control the numerical integration routine - choose from <code>ClassicalRK4</code> , <code>SimpleHeum</code> , <code>ImplicitEuler</code> , <code>SimpleRunge</code> , <code>ExplicitEuler</code> or <code>CashKarpRKF45</code> .
<code>spin_tracking</code>	Set to true to use G4 routines to precess the spin vector as particles go through EM fields.
<code>delta_one_step</code>	Accuracy with which Geant4 steps within a volume.
<code>epsilon_min</code>	Geant4 minimum stepping relative error over a single step. Takes precedence over <code>delta_one_step</code> .
<code>epsilon_max</code>	Geant4 maximum stepping relative error over a single step. Takes precedence over <code>delta_one_step</code> .
<code>delta_intersection</code>	Accuracy with which Geant4 enters volume boundaries.
<code>miss_distance</code>	Maximum distance between track and corners, used for estimating whether a track crosses a boundary.

Table 5.11: Physics list control parameters.

<i>Physics list controls.</i>	
<code>physics_model</code>	GEANT4 physics model used to set up the physics list.
<code>physics_processes</code>	Choose which physics processes normal particles observe during tracking. Options are <ul style="list-style-type: none"> • normal particles will obey normal physics processes, scattering and energy straggling will be active. • mean_energy_loss particles will lose a deterministic amount of energy during interaction with materials and will never decay. • none Particles will never lose energy or scatter during tracking and will never decay.
<code>reference_physics_processes</code>	Choose which physics processes the reference particle observes during tracking. Options are mean_energy_loss and none . The reference particle can never have stochastic processes enabled.
<code>particle_decay</code>	Set to boolean true to enable particle decay; set to boolean false to disable.
<code>polarised_decay</code>	Set to boolean true to make muons decay according to standard physics for a polarised muon; set to boolean false to make muons decay as if unpolarised. If polarised decay is true, then spin tracking is automatically enabled, regardless of the value of the <code>spin_tracking</code> datacard.
<code>charged_pion_half_life</code>	Set the half life for charged pions.
<code>muon_half_life</code>	Set the half life for muons.
<code>production_threshold</code>	Set the geant4 production threshold. Uses geant4 defaults if negative. Ignored if <code>physics_processes</code> are not normal .
<code>fine_grained_production_threshold</code>	Set the geant4 production threshold per particle and per region. See text.
<code>kinetic_energy_threshold</code>	Threshold for kinetic energy of new particles at production. Particles with kinetic energy below this value will not be tracked.
<code>default_keep_or_kill</code>	If set to true , keep particles with type not listed in <code>keep_or_kill_particles</code> . If set to false , kill particles with type not listed in <code>keep_or_kill_particles</code>
<code>keep_or_kill_particles</code>	Maps string particle type name to boolean flag. If set to true, always keep particles of this type. If set to false, always kill particles of this type. If not set, apply <code>default_keep_or_kill</code>

Table 5.12: Visualisation control parameters.

<i>Visualisation controls.</i>	
<code>geant4_visualisation</code>	Set to boolean true to activate GEANT4 visualisation.
<code>visualisation_viewer</code>	Control which viewer to use to visualise GEANT4 tracks. Currently only <code>vrmviewer</code> is compiled into GEANT4 by default. Users can recompile GEANT4 with additional viewers enabled at their own risk.
<code>visualisation_theta</code>	Set the theta angle of the camera.
<code>visualisation_phi</code>	Set the phi angle of the camera.
<code>visualisation_zoom</code>	Set the camera zoom.
<code>accumulate_tracks</code>	Set to 1 to accumulate all of the simulated tracks into one vrm file. 0 for multiple files.
<code>default_vis_colour</code>	Set the RGB values to alter the default colour of particles.
<code>pi_plus_vis_colour</code>	Set the RGB values to alter the colour of positive pions.
<code>pi_minus_vis_colour</code>	Set the RGB values to alter the colour of negative pions.
<code>mu_plus_vis_colour</code>	Set the RGB values to alter the colour of positive muons.
<code>mu_minus_vis_colour</code>	Set the RGB values to alter the colour of negative muons.
<code>e_plus_vis_colour</code>	Set the RGB values to alter the colour of positrons.
<code>e_minus_vis_colour</code>	Set the RGB values to alter the colour of electrons.
<code>gamma_vis_colour</code>	Set the RGB values to alter the colour of gammas.
<code>neutron_vis_colour</code>	Set the RGB values to alter the colour of neutrons.
<code>photon_vis_colour</code>	Set the RGB values to alter the colour of photons.

Chapter 6

Geometry

MAUS uses the on-line Configuration Database to store all of its geometries. These geometries have been transferred from CAD drawings which are based on the latest surveys and technical drawings available. The CAD drawings are translated to a geometry specific subset of XML, the Geometry Description Markup Language (GDML) prior to being recorded in the configuration database. Translation of the CAD drawings was accomplished through the use of a commercial software package known as Fast-RAD. This can be done using a combination of the open source software packages FreeCAD and CADMesh to translate the CAD drawings into a GEANT4 readable format; generation of an open source solution for MAUS is in progress.

The CAD drawings contain the beam-line elements and the positions of the detector survey points. These objects are described in the GDML files using Tessellated solids to define the shapes of the physical volumes. The detectors themselves are described using an independently generated set of GDML files using GEANT4 standard volumes. An additional XML file is appended to the geometry description that assigns magnetic fields and associates the detectors to their locations in the GDML files generated by Fast-RAD. This file is initially written by the geometry maintainers and formatted to contain run specific information during download.

The GDML format has a number of benefits. the files can be read via a number of already existing libraries in GEANT4 and ROOT for the purpose of independent verification and validation. For example the GEANT4 example “extended/persistance/gdml/G01” was used extensively for validating the GDML files produced by Fast-RAD. Because it is a subset of XML, the data contained in the GDML files are readily accessible through the application of the “libxml2” python extension. The GDML are in turn translated into the MAUS readable geometry files either by directly accessing the data using the python extension (which is the method applied to the detector objects) or through the use of EXtensible Stylesheet Language Transformations (XSLT) which applies a set of predefined transformations to the XML files.

The following section shall describe how to use the available executable to access and use these models.

6.1 Geometry Access Scripts

There are three executable files available to users which reside in the directory `/bin/utilities` found within your copy of MAUS. The three files of interest are `upload_geometry.py`, `download_geometry.py` and `get_geometry_ids.py`. These files do the following.

Upload Geometry

1. Set up the Configreader class and read the values provided by `ConfigurationDefaults.py` or by custom configure files.
2. Instantiate an Uploader class object using the upload directory and geometry note taken from the configuration file.
3. The list of files which is created by the Uploader class is used to compress the geometry files into one zip file.
4. This zip file is then used as the argument for the `upload_to_CDB` method which takes the contents of the zip and then uploads this, as a single string to the CDB.

Optional If cleanup is specified in the configuration file then the file list and the original GDML files are the deleted leaving only the zip file.

Download Geometry

1. Set up the Configreader() class and read the values provided by ConfigurationDefaults.py or by custom configuration files.
2. Instantiate a Downloader class object and downloads either the current, time specified or run number zipped geometry to a temporary cache location.
3. The zip file is then unzipped in this location.
4. The Formatter class is called which formats the GDML files. The formatting alters the schema location of these files and points them to the correct local locations of the Materials GDML file. This formatting leaves the original GDMLs in the temporary cache and places the new formatted files in the download directory specified by the configuration file.
5. GDMLtoMAUS is then called with the location of the new formatted files as its argument. This class converts the CAD GDMLs to the MICE Module text files using the XSLT stylesheets previously described and the Detector GDMLs to MICE modules using a python driven routine. Note that this step is used even when the geometry is designed for use with the GDMLParser.

Optional If specified in the configuration file the temporary cache location is removed along with the zip file and unzipped files.

- Get Geometry IDs**
1. Set up the Configreader() class and read the values provided by ConfigurationDefaults.py or by custom configuration files. This file takes start and stop time arguments to specify a period to search the CDB.
 2. A CDB class object is then instantiated with the server specified in the configuration file.
 3. The get ids method from the CDB class is called and the python dict which is downloaded is formatted and either printed to screen or to file as specified in the configuration file.

Two other python files are also present in the utilities directory; process_geometry.py which fits, formats, and processes the GDML files assuming the download is complete, and download_fit_geometry.py which downloads, formats, and processes the GDML files while applying the location fit— the GDML files generated for Step IV running will have the fit applied prior to upload. To use these files the user must use the arguments in the “ConfigurationDefaults.py” file. The arguments relating to these executables are as follows.

6.2 Using the Geometry Download Executables

The three executables described above will allow the user to accomplish three different tasks; adding a new geometry to the database, checking what geometries are available, and downloading the desired geometry. The majority of users will not need to upload a new geometry. At present this can only be done from the MLCR. The second two operations are of primary interest for the everyday user. A list of the CAD based geometries appears at <http://cdb.mice.rl.ac.uk/cdbviewer/>, and selecting the geometry tab. The user should be advised, however, that this list does not contain all of the information necessary to run the geometry download procedure. The best procedure is to use the get_geometry_ids.py executable described above. For example to get all available entries in the geometry database a user should run the command (from the maus root directory)

```
> python /bin/utilities/get_geometry_ids.py
   --get_ids_start_time ‘‘1999-01-01 00:00:00’’ --get_ids_stop_time ‘‘2035-01-01 00:00:00’’
```

By default, the output file is saved to \$MAUS_ROOT_DIR/tmp/geometry_ids.txt. The typical output looks like the following:

```
[...]
Geometry Number = 46
Geometry Note   = Step I geometry consistent with the October 2011 data run. All detector
                  descriptions consistent and up to date.
ValidFrom       = 2011-12-01 19:17:00
```

Table 6.1: Geometry control parameters.

<i>Geometry controls.</i>	
<code>cdb_upload_url</code>	Sets the upload url relating to the Configuration Database.
<code>cdb_download_url</code>	Sets the download url relating to the Configuration Database.
<code>cdb_cc_download_url</code>	Sets the download url relating to the Configuration Database for the super-conducting channels only.
<code>geometry_download_wsdl</code>	Name of the web service used for downloads.
<code>geometry_download_directory</code>	Set the directory where you wish the geometry to be downloaded to.
<code>geometry_download_by</code>	This can be set to either <i>current</i> , <i>id</i> or <i>run_number</i> . Current will download the current valid geometry stored on the CDB. ID will download the geometry for the ID specified N.B ID numbers can be found using the <code>get geometry ids</code> executable. Run_number will download the geometry along with control room information for specified run including the beam-line currents.
<code>geometry_download_run_number</code>	Set the number of the run to be downloaded.
<code>geometry_download_beamline_for_run</code>	Set the beamline information to match a run independent of the geometry download. To be used when geometry is downloaded by ID.
<code>geometry_download_coolingchannel_tag</code>	Download the cooling channel data matching a specific tag.
<code>geometry_download_id</code>	Set the number of the geometry ID to be downloaded.
<code>geometry_download_cleanup</code>	Set to True in order to cleanup the temporary files created during the download process. These are the zip file downloaded and the original GDML files from this zip file.
<code>g4_step_max</code>	Set the G4 step max number which will be set in the ParentGeometryFile. This relates to the size of steps carried out during the simulation.
<code>geometry_upload_wsdl</code>	Name of the web service used for uploads. For developers use only.
<code>geometry_upload_directory</code>	Set the the directory which stores the Fast-RAD produced GDML files which will be stored on the CDB. For Developers use only.
<code>geometry_upload_note</code>	Write the description of the geometry which is going to be uploaded. This should describe what is in the beam line specifically what is new to the model. It should also include any other information the developer wishes the user to know. For developers use only.
<code>geometry_upload_valid_from</code>	Set the date-time format of the date when this geometry about to be uploaded is valid from. For developers use only.
<code>geometry_upload_cleanup</code>	Set to True in order to cleanup the temporary files created during the upload process. These are the file containing the list of GDMLs to be uploaded and also the original GDML files. For developers use only.
<code>get_ids_start_time</code>	Set the start time of the period which you would like to get the ids from the configuration database. Must be in date-time format.
<code>get_ids_stop_time</code>	Set the stop time of the period which you would like to get the ids from the configuration database. Must be in date-time format.
<code>get_ids_create_file</code>	Set to True in order to create a file which lists the geometries available within the time period specified. If set to False the geometry information will be printed to screen.

Date Created = 2015-01-07 14:19:51.055000

Geometry Number = 47

Geometry Note = Step I geometry consistent with the October 2013 EMR comissioning run.
All detector descriptions consistent and up to date.

ValidFrom = 2013-10-06 19:17:00

Date Created = 2015-01-07 14:30:32.987000

Geometry Number = 49

Geometry Note = Step IV geometry with detectors including the TOFs, Ckov, EMR, Tracker,
and KL included as GDML files. Update to the EMR geometry.

ValidFrom = 2034-01-03 19:17:00

Date Created = 2015-03-23 17:24:23.079000

Geometry Number = 50

Geometry Note = Step IV geometry with detectors including the TOFs, Ckov, EMR, Tracker,
and KL included as GDML files. Written for GDMLParser. Diffuser
corrected to match design specification.

ValidFrom = 2034-05-13 19:17:00

Date Created = 2015-05-14 16:29:01.124000

Three different flavors of geometry are represented here. The first is the geometry of the Step I geometry as it existed in the hall during data collection in Autumn 2013 (id 47). This description includes the survey information taken prior to data collection although the positions of the detectors have not been adjusted to match that information in the upload; a fit must be done at download time. The second is a prospective Step IV geometry based on the CAD geometry (id 49). This geometry was intended to be used after the MICE module translation. In contrast the third type of geometry is meant to be used with the GDMLParser (id 50). This geometry should load in a much shorter time than the MICE module translation due to the optimized treatment of the tessellated solid objects. Both of these last two cases do not contain survey information and are therefore dated to be valid from a date far in the future (2034).

The CAD-based geometry can be downloaded via a number of different modes. The simplest way is to download the geometry by its id number. From the MAUS root directory the debug geometry as described above can be downloaded with the command

```
> python bin/utilities/download_geometry.py --geometry_download_id 50
```

By default the unformatted GDML files will be removed with this command. If the user wishes to download the full geometry without removing the unformatted GDML files because that user wants to run a systematic study requiring reprocessing the geometry then the following command should be used:

```
> python bin/utilities/download_geometry.py --geometry_download_id 50  
--geometry_download_cleanup False
```

A more complicated use is to test a prospective geometry with a predefined beamline setting as defined using a “tagged” beamline:

```
> python bin/utilities/download_geometry.py --geometry_download_id 50  
--geometry_download_beamline_tag '6-200+M0'
```

A common usage for the geometry download is to reproduce a given run. To simulate a representative run from the 2013 EMR run the following command should be used:

```
> python bin/utilities/download_fit_geometry.py --geometry_download_by run_number  
--geometry_download_run 5519
```

This function reads the beamline currents from the configuration database and adjusts the fields of the beamline magnets appropriately.

A final application is to download the latest uploaded geometry. This function can be completed using the following command:

```
> python bin/utilities/download_fit_geometry.py --geometry_download_by current
```

All of these commands described will by default place the geometry in the directory \$MAUS_ROOT_DIR/files/geometry/download. This directory may be changed using the --geometry_download_directory flag. To use the downloaded geometry in the simulation, the --simulation_geometry_filename flag must be set to the download directory.

6.3 A Little GDML

While the detectors are already defined and the beam line elements are defined from the CAD information, it is potentially useful for users and developers to understand these data structures. The overall structure of a GDML file is always the same; the lithium hydride disk absorber is described using the following lines

```
<?xml version="1.0" encoding="UTF-8" standalone="no" ?>
<gdml xmlns:xsi="http://www.w3.org/2001/XMLSchema-instance" xsi:
  noNamespaceSchemaLocation="http://service-spi.web.cern.ch/service-spi/app/
  releases/GDML/schema/gdml.xsd">
  <define/>
  <materials>
    <isotope name="Li6" Z="3" N="6" formula="6Li">
      <MEE value="6.015122" unit="eV"/>
      <D value="0.534" unit="g/cm3"/>
      <atom value="6.00" unit="g/mole"/>
    </isotope>
    <isotope name="Li7" Z="3" N="7" formula="7Li">
      <MEE value="7.016004" unit="eV"/>
      <D value="0.534" unit="g/cm3"/>
      <atom value="7.00" unit="g/mole"/>
    </isotope>
    <element name="Li">
      <fraction n="0.075" ref="Li6"/>
      <fraction n="0.925" ref="Li7"/>
    </element>
    <element name="H" N="1" Z="1" formula="H">
      <atom value="1.008" unit="g/mole"/>
    </element>
    <material name="LITHIUM_HYDRIDE">
      <D value="0.78" unit="g/cm3"/>
      <composite n="1" ref="Li"/>
      <composite n="1" ref="H"/>
    </material>
  </materials>
  <solids>
    <tube rmax="225.0" z="65" lunit="mm" deltaphi="360" aunit="degree" name="
      disk_solid"/>
  </solids>
  <structure>
    <volume name="Disk_LiH">
      <materialref ref="LITHIUM_HYDRIDE"/>
      <solidref ref="disk_solid"/>
      <auxiliary auxtype="BlueColour" auxvalue="0.5"/>
      <auxiliary auxtype="SensitiveDetector" auxvalue="SpecialVirtual"/>
    </volume>
  </structure>
  <setup name="Default" version="1.0">
    <world ref="Disk_LiH"/>
  </setup>
</gdml>
```

More fundamental definitions appear at the top while more derived objects appear at the bottom culminating in the “world” definition as the last object. Variables are defined in the “define” section, material definitions appear in the “materials” section, solid objects used in the definition of the structure appear in the “solids” section, and the volumes making up the simulated geometry appear in the

“structure” section. A little more detail and MICE specific examples are given below, but it is highly suggested that an interested user refer to the “GDML Users Guide”¹.

6.3.1 Define

This is where constants, matrices, and variables are defined. The obvious benefit is that any variables defined here may be referenced multiple times throughout the GDML document. Trivial examples include the definition of pi or the identity rotation. A slightly more interesting example is the use of a matrix in `EMR.gdml` to indicate whether a 90° rotation needs to be applied to a scintillator bar or a plane at a given location.

6.3.2 Materials

All materials are defined internally to the GDML file. Each detector has only the materials used in its construction defined in the source file, while a stock summary of all materials used are written to the files derived from the MICE engineering drawings. Materials are composed of elements or mixtures of elements defined by the mass fraction or the atom count.

6.3.3 Solids

The definition of solid objects parallels the definition of solids in Geant. Primitive solids such as spheres, tubes, cones, and boxes, may be explicitly defined. All of the detectors are defined entirely using primitive volumes. More complicated, tessellated solids may also be defined, with the vertices written to the “define” section of the code. The MICE engineering drawings are defined entirely using tessellated solids using the FastRAD package.

6.3.4 Structure

Definition of the geometry volume is contained in the structure section of the file. Volumes are defined based on references to predefined solids and materials. Daughter volumes to objects may be defined through the use of `physvol` and `paramvol`. Relative positions and rotations of daughter objects are defined as part of these definitions. Loops and ensembles may also be used to define multiple copies of objects displaced in position or rotations.

6.3.5 Additional Features and Sensitive Detectors

When defining a volume it is possible to define auxiliary properties. These properties do not affect the structural behaviour of the detector within the simulation but may be used to alter the properties of the simulation. An example is the sensitive detector definition. For every volume with a auxiliary property `SensitiveDetector` a matching sensitive detector object is constructed and linked to the source volume. The requirements of the MICE sensitive detector objects to use detector identity information explicitly written to the MICE module files have forced the GDML files to avoid the use of loops for the definition of repeated objects within the TOFs and the Trackers. No such requirement exists for the definition of sensitive detectors in the EMR because the sensitive detectors are defined using GEANT’s native touchable volume definitions.

6.4 Creation of New Geometries in MAUS

A python class, `CADModuleExtraction`, is available that automatically generates a set of geometry files suitable for upload to CDB. It is run during the course of the standard installation tests to provide a native version of the Step IV geometry but this class should not be run by the casual user. To use this class the user must provide a GDML file containing references to all of the GDML files generated from the CAD and the detector GDML files positioned in their approximate locations (which should be furnished by a subset of the CAD drawings) as well as the location of a MAUS information file, which need not be in the same directory as the source GDML file. A destination directory and file name must also be provided. The script then runs through the referenced GDML files and copies the objects contained therein to a new set of defined by location, instead of by material which is the arrangement required by

¹<http://gdml.web.cern.ch/GDML/doc/GDMLmanual.pdf>

the CAD model. This processing is required to make a single set of files that can be read into GEANT4 efficiently. The output of this script may be uploaded to CDB after applying corrections to the detector locations based on the fits to the survey information and passing the validation tests.

Chapter 7

How to Define a Geometry

Mice Modules are the objects that control the geometry and fields that are simulated in MAUS. They are used in conjunction with a datacard file, which provides global run control parameters. Mice Modules are created by reading in a series of text files when MAUS applications are run.

This geometry information is used primarily by the Simulation application for tracking of particles through magnetic fields. A few commands are specific to detector Reconstruction and accelerator beam Optics applications.

The Mice Modules are created in a tree structure. Each module is a parent of any number of child modules. Typically the parent module will describe a physical volume, and child modules will describe physical volumes that sit inside the parent module. Modules cannot be used to describe volumes that do not sit at least partially inside the volume of the parent module.

Each Mice Module file consists of a series of lines of text. Firstly the Module name is defined. This is followed by an opening curly bracket, then the description of the module and the placement of any child modules, and finally a closing curly bracket. Commands, curly brackets etc must be separated by an end of line character.

Comments are indicated using either two slashes or an exclamation mark. Characters placed after a comment on a line are ignored.

MAUS operates in a right handed coordinate system (x, y, z) . In the absence of any rotation, lengths are considered to be extent along the z -axis, widths to be extent along the x -axis and heights to be extent along the y -axis. Rotations $(\theta_x, \theta_y, \theta_z)$ are defined as a rotation about the z -axis through θ_z , followed by a rotation about the y -axis through θ_y , followed by a rotation about the x -axis through θ_x .

7.0.1 Configuration File

The Configuration file places the top level objects in MICE. The location of the file is controlled by the datacard `simulation_geometry_file_name`. MAUS looks for the configuration file in the first instance in the directory

```
`${MICEFILES}/Models/Configuration/<MiceModel>
```

where ``${MICEFILES}` is a user-defined environment variable. If MAUS fails to find the file it searches the local directory.

The world volume is defined in the Configuration file and any children of the world volume are referenced by the Configuration file. The Configuration file looks like

```
Configuration <Configuration Name>
{
    Dimensions <x> <y> <z> <Units>
    <Properties>
    <Child Modules>
}
```

`<Configuration Name>` is the name of the configuration. Typically the Configuration file name is given by `<Configuration Name>.dat`. The world volume is always a rectangular box centred on $(0, 0, 0)$ with x , y , and z extent set by the Dimensions. Properties and Child Modules are described below and added as in any Module.

Substitutions

It is possible to make keyword substitutions that substitutes all instances of <name> with <value> in all Modules. The syntax is

```
Substitution <name> <value>
```

<name> must start with a single \$ sign. Substitutions must be defined in the Configuration file. Note this is a direct text substitution in the MiceModules before the modules are parsed properly. So for example,

```
Substitution $Sub SomeText
PropertyString FieldType \ $Sub}
PropertyDouble \ $SubValue 10}
```

would be parsed as MAUS like

```
PropertyString FieldType SomeText}
PropertyDouble SomeTextValue 10}
```

Expressions

The use of equations in properties of type double and Hep3Vector is also allowed in place of a single value. So, for example,

```
PropertyDouble FieldStrength 0.5*2 T
```

would result in a FieldStrength property of 1 Tesla.

Expression Substitutions

Some additional variables can be defined in specific cases by MAUS itself for substitution into expressions, in which case they will start with @ symbol. For these variable substitutions, it is only possible to make the substitution into expressions. So for example,

```
PropertyDouble ScaleFactor 2*@RepeatNumber
```

Would substitute @RepeatNumber into the expression. @RepeatNumber is defined by MAUS when repeating modules are used (see RepeatModule2, below). Note the following code is not valid

```
PropertyString FileName File@RepeatNumber //NOT VALID
```

This is because Expression Substitutions can only be used in an expression (i.e. an equation).

7.0.2 Module Files

Children of the top level Mice Module are defined by Modules. MAUS will attempt to find a module in an external file. The location of the file is controlled by the parent Module. Initially MAUS looks in the directory

```
${MICEFILES}/Models/Modules/<Module>
```

If the Mice Module cannot be found, MAUS searches the local directory. If the module file still cannot be found, MAUS will issue a warning and proceed.

The Module description is similar in structure to the Configuration file:

```
Module <Module Name>
{
  PropertyString Volume <Volume Type>
  PropertyHep3Vector Dimensions <Dimension1> <Dimension2> <Dimension3> <Units>
  <Properties>

  <Child Modules>
}
```

<Module Name> is the name of the module. Typically the Module file name is given by <Module Name>.dat. The definition of Volume, Dimensions, Properties and Child Modules are described below.

Table 7.1: My caption

Volume	Dimension1	Dimension2	Dimension3
None	No dimensions required. Note cannot define daughter Modules for this volume type.		
Cylinder	Radius	Length in z	Not used (leave blank)
Box	Width in x	Height in y	Length along z
Tube	Inner Radius	Outer Radius	Length in z
Trapezoid	Half Width in x	Half Height in y	Half length in z
Wedge	See documentation below.		
Polycone	No dimensions required. Volume defined from external file.		
Quadrupole	No dimensions required. Dimensions defined from module properties.		
Multipole	No dimensions required. Dimensions defined from module properties.		
Boolean	No dimensions required. Dimensions defined from module properties.		
Sphere	See documentation below.		

7.0.3 Volume and Dimensions

The volume described by the MiceModule can be one of several types. Replace `<Volume Type>` with the appropriate volume below. Cylinder, Box and Tube define cylindrical and cuboidal volumes. Polycone defines an arbitrary volume of rotation and is described in detail below. Wedge describes a wedge with a triangular projection in the y-z plane and rectangular projections in x-z and x-y planes. Quadrupole defines an aperture with four cylindrical pole tips.

In general, the physical volumes that scrape the beam are defined independently of the field maps. This is the more versatile way to do things, but there are some pitfalls which such an implementation introduces. For example, in hard-edged fields like pillboxes, tracking errors can be introduced when MAUS steps into the field region. This can be avoided by adding windows (probably made of vacuum material) to force GEANT4 to stop tracking, make a small step over the field boundary, and then restart tracking inside the field. However, such details are left for the user to implement.

7.0.4 Properties

Many of the features of MAUS that can be enabled in a module are described using properties. For example, properties enable the user to define detectors and fields. Properties can be either of several types: PropertyDouble, PropertyString, PropertyBool, PropertyHep3Vector or PropertyInt. A property is declared via

```
<Property Type> <Property Name> <Value> <Units if appropriate>
```

Different properties that can be enabled for Mice Modules are described elsewhere in this document. Properties of type PropertyDouble and PropertyHep3Vector can have units. Units are defined in the CLHEP library. Units are case sensitive; MAUS will return an error message if it fails to parse units. Combinations of units such as T/m or N*m can be defined using '*' and '/' as appropriate. Properties cannot be defined more than once within the same module.

7.0.5 Child Modules

Child Modules are defined with a position, rotation and scale factor. This places, and rotates, the child volume and any fields present relative to the parent volume. Scale factor scales fields defined in the child module and any of its children. Scale factors are recursively multiplicative; that is the field generated by a child module will be scaled by the product of the scale factor defined in the parent module and all of its parents.

The child module definition looks like:

```
Module <Module File Name>
{
  PropertyHep3Vector Position <x position> <y position> <z position> <Units>
  PropertyHep3Vector Rotation <x rotation> <y rotation> <z rotation> <Units>
  PropertyDouble ScaleFactor <Value>
  <Define volume, dimensions and properties for this instance only>
}
```

MAUS searches for <Module File Name> first relative to $\${MICEFILES}/Models/Modules/$ and subsequently relative to the current working directory. The position and rotation default to 0,0,0 and the scale factor defaults to 1.

- Volume, Dimension and Properties of the child module can be defined at the level of the parent; in this case these values will be used only for this instance of the module.
- If no file can be found, MAUS will press on regardless, attempting to build a geometry using the information defined in the parent volume.

7.0.6 Module Hierarchy and GEANT4 Physical Volumes

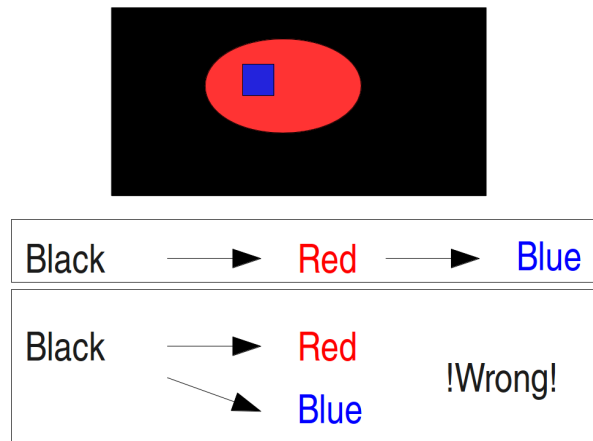

Figure 7.1: The diagram shows a schematic for a square placed inside a cylinder inside a rectangle. This nesting must be replicated in the MiceModules in order for the volumes to be correctly represented by MAUS.

MAUS enables users to place arbitrary physical volumes in a GEANT4 geometry. The formatting of MAUS is such that users are encouraged to use the GEANT4 tree structure for placing physical volumes. This is a double-edged sword, in that it provides users with a convenient interface for building geometries, but it is not a terribly safe interface.

Consider the cartoon of physical volumes shown above. Here there is a blue volume sitting inside a red volume sitting inside the black world volume. For the volumes to be represented properly, the module that represents the blue volume MUST be a child of the module that represents the red volume. The module that represents the red volume MUST, in turn, be a child of the module that represents the black volume, in this case the Configuration file.

What would happen if we placed the blue volume directly into the Black volume, i.e. the Configuration file? GEANT4 would silently ignore the blue volume, or the red volume, depending on the order in which they are added into the GEANT4 geometry. What would happen if we placed the blue volume overlapping the red and black volumes? The behaviour of GEANT4 is not clear in this case.

- Never allow a volume to overlap any part of another volume that is not its direct parent.

It is possible to check for overlaps by setting the datacard *CheckVolumeOverlaps* to 1.

7.0.7 A Sample Configuration File

Below is listed a sample configuration file, which is likely to be included in the file *ExampleConfiguration.dat*; the actual name is specified by the datacard MiceModel.

```
Configuration ExampleConfiguration
{
  Dimensions 1500.0 1000.0 5000.0 cm
  PropertyString Material AIR
```

```

Substitution $MyRedColour 0.75
Module BeamLine/SolMag.dat
{
    Position 140.0 0.0 -2175.0 cm
    Rotation 0.0 30.0 0.0 degree
    ScaleFactor 1.
}
Module BeamLine/BendMag.dat
{
    Position 0.0 0.0 -1935.0 cm
    Rotation 0.0 15.0 0.0 degree
    ScaleFactor 1.
}
Module NoFile_Box1
{
    Volume Box
    Dimension 1.0 1.0 1.0
    Position 0.0 0.0 200.0 cm
    Rotation 0.0 15.0 0.0 degree
    PropertyString Material Galactic
    PropertyDouble RedColour $MyRedColour
}
Module NoFile_Box2}
{
    Volume Box
    Dimension 0.5 0.5 0.5*3 m //z length = 0.5*3 = 1.5 m
    Rotation 0.0 15.0 0.0 degree //Rotation relative to parent
    PropertyString Material Galactic
    PropertyDouble RedColour $MyRedColour
}
}

```

7.0.8 A Sample Child Module File

Below is listed a sample module file, which is likely to be included in the file *SolMag.dat*; the actual location is specified by the module or configuration that calls FCoil. The module contains a number of properties that define the field.

```

Module SolMag
{
    Volume Tube
    Dimensions 263.0 347.0 210.0 mm
    PropertyString Material Al
    PropertyDouble BlueColour 0.75
    PropertyDouble GreenColour 0.75
    //field}
    PropertyString FieldType Solenoid
    PropertyString FileName focus.dat
    PropertyDouble CurrentDensity 1.
    PropertyDouble Length 210. mm
    PropertyDouble Thickness 84. mm
    PropertyDouble InnerRadius 263. mm
}

```

Chapter 8

Geometry and Tracking MiceModule Properties

In general, MAUS treats physical geometry distinct from fields. Fields can be placed overlapping physical objects, or entirely independently of them, as the user desires. Properties for various aspects of the physical and engineering model of the simulation are described below. This includes properties for sensitive detectors.

8.1 General Properties

There are a number of properties that are applicable to any MiceModule.

Property	Type	Description
Material	string	The material that the volume is made up from
Invisible	bool	Set to 1 to make the object invisible in visualisation, or 0 to make the object visible.
RedColour	double	Alter the colour of objects as they are visualised
GreenColour	double	
BlueColour	double	
G4StepMax	double	The maximum step length that Geant4 can make in the volume. Inherits values from the parent volumes.
G4TrackMax	double	The maximum track length and particle time of a track. Tracks outside this bound are killed. Inherits values from the parent volumes.
G4TimeMax	double	
G4KinMin	double	The minimum kinetic energy of a track. Tracks outside this bound are killed. Inherits values from the parent volumes.
SensitiveDetector	string	Set to the type of sensitive detector required. Possible sensitive detectors are <i>TOF</i> , <i>SciFi</i> , <i>CKOV</i> , <i>SpecialVirtual</i> , <i>Virtual</i> , <i>Envelope</i> or <i>EMCAL</i> .
Region	string	Allocate the volume to the named Geant4 Region. This is used for setting up production thresholds (see simulation chapter). Child modules are automatically assigned to the parent module's region. The Root module is automatically assigned to <code>DefaultRegionForTheWorld</code> .

8.2 Sensitive Detectors

A sensitive detector (one in which hits are recorded) can be defined by including the SensitiveDetector property. When a volume is set to be a sensitive detector MAUS will automatically record tracks entering, exiting and crossing the volume. Details such as the energy deposited by the track are sometimes also recorded in order to enable subsequent modelling of the detector response.

Some sensitive detectors use extra properties.

8.2.1 Scintillating Fibre Detector (SciFi)

8.2.2 Cerenkov Detector (CKOV)

8.2.3 Time Of Flight Counter (TOF)

8.2.4 Special Virtual Detectors

Special virtual detectors are used to monitor tracking through a particular physical volume. Normally particle tracks are written in the global coordinate system, although an alternate coordinate system can be defined. Additional properties can be used to parameterise special virtual detectors.

Property	Type	Description
ZSegmentation	int	Set the number of segments in the detector in Z, R or f. Defaults to 1.
PhiSegmentation	int	
RSegmentation	int	
SteppingThrough	bool	Set to true to record tracks stepping through, into, out of or across the volume. Defaults to true.
SteppingInto	bool	
SteppingOutOf	bool	
SteppingAcross	bool	
Station	int	Define an integer that is written to the output file to identify the station. Defaults to a unique integer identifier chosen by MAUS, which will be different each time the same Special Virtual is placed.
LocalRefRotation	Hep3 Vector	If set, record hits relative to a reference rotation in the coordinate system of the SpecialVirtual detector.
GlobalRefRotation	Hep3 Vector	If set, record hits relative to a reference rotation in the coordinate system of the Configuration.
LocalRefPosition	Hep3 Vector	If set, record hits relative to a reference position in the coordinate system of the SpecialVirtual detector.
GlobalRefPosition	Hep3 Vector	If set, record hits relative to a reference position in the coordinate system of the Configuration.

8.2.5 Virtual Detectors

Virtual detectors are used to extract all particle data at a particular plane, irrespective of geometry. Virtual detectors do not need to have a physical volume. The *plane* can be a plane in z, time, proper time, or a physical plane with some arbitrary rotation and translation.

Property	Type	Description
<i>IndependentVariable</i>	String	<ul style="list-style-type: none"> • If set to <i>t</i>, particle data will be written for particles at the time defined by the <i>PlaneTime</i> property. • If set to <i>tau</i>, particle data will be written for particles at the proper time defined by the <i>PlaneTime</i> property. • If set to <i>z</i>, particle data will be written for particles crossing the module's z-position. • If set to <i>u</i>, particle data will be written for particles crossing a plane extending in <i>x</i> and <i>y</i>.

Property	Type	Description
<i>PlaneTime</i>	Double	If <i>IndependentVariable</i> is <i>t</i> or <i>tau</i> , particle data will be written out at this time. Mandatory if <i>IndependentVariable</i> is <i>t</i> or <i>tau</i> .
RadialExtent	Double	If set, particles outside this radius in the plane of the detector will not be recorded by the Virtual detector.
GlobalCoordinates	Bool	If set to 0, particle data is written in the coordinate system of the module. Otherwise particle data is written in global coordinates.
MultiplePasses	String	Set how the VirtualPlane handles particles that pass through more than once. If set to Ignore, particles will be ignored on second and subsequent passes. If set to SameStation, particles will be registered with the same station number. If set to NewStation, particles will be registered with a NewStation number given by the <i>(total number of stations) + (this plane's station number)</i> , i.e. a new station number appropriate for a ring geometry.
AllowBackwards	Bool	Set to false to prevent backwards-going particles from being recorded. Default is true.

8.2.6 Envelope Detectors

Envelope detectors are a type of Virtual detector that take all of the properties listed under virtual detectors, above. In addition, in the optics application they can be used to interact with the beam envelope in a special way. The following properties can be defined for Envelope Detectors *in addition to* the properties specified above for virtual detectors.

The The EnvelopeOut properties are used to make output from the envelope for use in the Optics optimiser.

<i>EnvelopeOut1_Name</i>	String	Defines the variable name that can be used as an expression substitution at the end of each iteration, typically substituted into the Score parameters in the optimiser (see optimiser, below).
<i>EnvelopeOut1_Type</i>	String	Defines the type of variable that will be calculated for the substitution. Options are <ul style="list-style-type: none"> • Mean • Covariance • Standard_Deviation • Correlation • Bunch_Parameter
<i>EnvelopeOut1_Variable</i>	String	Defines the variable that will be calculated for the substitution. Options are for Bunch_Parameter <ul style="list-style-type: none"> • <i>emit_6d</i> : 6d emittance • <i>emit_4d</i>: 4d emittance (in x-y space) • <i>emit_t</i>: 2d emittance (in time space) • <i>emit_x</i>: 2d emittance (in x space) • <i>emit_y</i>: 2d emittance (in y space) • <i>beta_4d</i>: 4d transverse beta function • <i>beta_t</i>: 2d longitudinal beta function • <i>beta_x</i>: 2d beta function (in(x space) • <i>beta_y</i>: 2d beta function (in y space) • <i>alpha_4d</i>: 4d transverse alpha function • <i>alpha_t</i>: 2d longitudinal alpha function • <i>alpha_x</i>: 2d alpha function (in(x space) • <i>alpha_y</i>: 2d alpha function (in y space) • <i>gamma_4d</i>: 4d transverse gamma function • <i>gamma_t</i>: 2d longitudinal gamma function • <i>gamma_x</i>: 2d gamma function (in(x space) • <i>gamma_y</i>: 2d gamma function (in y space) • <i>disp_x</i>: x-dispersion • <i>disp_y</i>: y-dispersion • <i>ltwiddle</i>: normalised angular momentum • <i>lkin</i>: standard angular momentum <p>For Mean, Standard_Deviation, Covariance and Correlation, variables should be selected from the options</p> <ul style="list-style-type: none"> • <i>x</i>: x-position • <i>y</i>:y-position • <i>t</i>: time • <i>px</i>: x-momentum • <i>py</i>: y-momentum • <i>E</i>: energy <p>For Mean, a single variable should be selected and value corresponding to the reference trajectory will be returned. For Standard_Deviation, a single variable should be selected and the 1 sigma beam size will be returned. For Covariance and Correlation, two variables should be selected separated by a comma.</p>

8.3 Unconventional Volumes

It is possible to define a number of volumes that use properties rather than the Dimensions keyword to define the volume size.

Volume Trapezoid

Volume Trapezoid gives a trapezoid which is not necessarily isosceles. Its dimensions are given by:

Property	Type	Description
TrapezoidWidthX1	Double	Gives width1 in x
TrapezoidWidthX2	Double	Gives width2 in x
TrapezoidWidthY1	Double	Gives height1 in y
TrapezoidWidthY2	Double	Gives height2 in y
TrapezoidLengthZ	Double	Gives length along z

8.3.1 Trapezoid Volume

A Trapezoid Volume is like a Wedge Volume (look visualization below) with the possibility to have different values for x width and 2 (non-zero) values for y.

8.3.2 Volume Wedge

A wedge is a triangular prism as shown in the diagram. Here the blue line extends along the positive z-axis and the red line extends along the x-axis.

Property	Type	Description
Dimensions	Hep3 Vector	<ol style="list-style-type: none"> 1. Width of the prism in x 2. Open end height of the prism in y 3. Length of the prism in z

8.3.3 Volume Polycone

A polycone is a volume of rotation, defined by a number of points in r and z. The volume is found by a linear interpolation of the points.

Property	Type	Description
PolyconeType	string	Set to Fill to define a solid volume of rotation. Set to Cone to define a shell volume of rotation with an inner and outer surface.
FieldMapMode	string	The name of the file that contains the polycone data.

8.3.4 Volume Quadrupole

Quadrupoles are defined by an empty cylinder with four further cylinders that are approximations to pole tips.

Property	Type	Description
PhysicalLength	double	The length of the quadrupole container.
QuadRadius	double	The distance from the quad centre to the outside of the quad.
PoleTipRadius	double	The distance from the quad centre to the pole tip.
CoilRadius	double	
CoilHalfWidth	double	
BeamlineMaterial	string	The material from which the beamline volume is made.
QuadMaterial	string	The material from which the quadrupole volume is made.

8.3.5 Volume Multipole

Multipoles are defined by an empty box with an arbitrary number of cylinders that are approximations to pole tips. Poles are placed around the centre of the box with n-fold symmetry. Multipoles can be curved, in which case poles cannot be defined – only a curved rectangular aperture will be present.

Property	Type	Description
<i>ApertureCurvature</i>	double	Radius of curvature of the multipole aperture. For now curved apertures cannot have poles. Set to 0 for a straight aperture.
<i>ApertureLength</i>	double	Length of the multipole aperture.
NumberOfPoles	int	Number of poles.
PoleCentreRadius	double	The distance from the centre of the aperture to the centre of the cylindrical pole.
PoleTipRadius	double	The distance from the centre of the aperture to the tip of the cylindrical pole.
<i>ApertureInnerHeight</i>	double	The inner full height of the aperture.
<i>ApertureInnerWidth</i>	double	The inner full width of the aperture.
<i>ApertureOuterHeight</i>	double	The outer full height of the aperture.
<i>ApertureOuterWidth</i>	double	The outer full width of the aperture.

8.3.6 Volume Boolean

Boolean volumes enable several volumes to be combined to make very sophisticated shapes from a number of elements. Elements can be combined either by union, intersection or subtraction operations. A union creates a volume that is the sum of two elements; an intersection creates a volume that covers the region where two volumes intersect each other; and a subtraction creates a volume that contains all of one volume except the region that another volume sits in.

Boolean volumes combine volumes modelled by other MiceModules (submodules), controlled using the properties listed below. Only the volume shape is used; position, rotation and field models etc are ignored. Materials, colours and other relevant properties are all taken only from the Boolean Volume's properties.

Note that unlike in other parts of MAUS, submodules for use in Booleans (BaseModule, BooleanModule1, BooleanModule2 ...) must be defined in a separate file, either defined in \$MICEFILES/Models/Modules or in the working directory.

Also note that visualisation of boolean volumes is rather unreliable. Unfortunately this is a feature of GEANT4. An alternative technique is to use special virtual detectors to examine hits in boolean volumes.

Property	Type	Description
<i>BaseModule</i>	string	Name of the physical volume that the BooleanVolume is based on. This volume will be placed at (0,0,0) with no rotation, and all subsequent volumes will be added, subtracted or intersected with this one.
<i>BooleanModule1</i>	string	The first module to add. MAUS will search for the MiceModule with path \$MICEFILES/Models/Modules/<BooleanModule1>.
<i>BooleanModule1Type</i>	string	The type of boolean operation to apply, either "Union", "Intersection" or "Subtraction".
<i>BooleanModule1Pos</i>	Hep3 Vector	The position of the new volume with respect to the Base volume.
<i>BooleanModule1Rot</i>	Hep3 Vector	The rotation of the new volume with respect to the Base volume.
<i>BooleanModuleN</i>	string	Add extra modules as required. Replace "N" with the module number. N must be a continuous series incrementing by 1 for each new module. Note that the order in which modules are added is important – (A-B) U C is different to A-(B U C).

Property	Type	Description
<i>BooleanModuleNType</i>	string	
<i>BooleanModuleNPos</i>	Hep3 Vector	
<i>BooleanModuleNRot</i>	Hep3 Vector	

8.3.7 Volume Sphere

A sphere is a spherical shell, with options for opening angles to make segments.

Property	Type	Description
<i>Dimensions</i>	Hep3 Vector	The x value defines the inner radius. The y value defines the outer radius of the shell. The z value is not used.
Phi	Hep3 Vector	The x value defines the start opening angle in phi. The y value defines the end opening angle. The z value is not used. Phi values must be in the range 0 to 360 degrees. If undefined, defaults to the range 0-360 degrees.
Theta	Hep3 Vector	The x value defines the start opening angle in theta. The y value defines the end opening angle. The z value is not used. Theta values must be in the range 0 to 180 degrees. If undefined, defaults to the range 0-360 degrees.

8.4 Repeating Modules

It is possible to set up a repeating structure for e.g. a repeating magnet lattice. The RepeatModule property enables the user to specify that a particular module will be repeated a number of times, with all properties passed onto the child module, but with a new position, orientation and scale factor. Each successive repetition will be given a translation and a rotation relative to the coordinate system of the previous repetition, enabling the construction of circular and straight accelerator lattices. Additionally, successive repetitions can have fields scaled relative to previous repetitions, enabling for example alternating lattices.

Property	Type	Description
<i>RepeatModule</i>	bool	Set to 1 to enable repeats in this module.
<i>NumberOfRepeats</i>	int	Number of times the module will be repeated in addition to the initial placement.
<i>RepeatTranslation</i>	Hep3 Vector	Translation applied to successive repeats, applied in the coordinate system of the previous repetition.
<i>RepeatRotation</i>	Hep3 Vector	Rotation applied to successive repeats, applied in the coordinate system of the previous repetition.
<i>RepeatScaleFactor</i>	double	ScaleFactor applied to successive repeats, applied relative to previous repetition's scale factor.

The RepeatModule2 property also enables the user to specify that a particular module will be repeated a number of times. In this case, MAUS will set a substitution variable @RepeatNumber that holds an index between 0 and NumberOfRepeats. This can be used in an expression in to provide a versatile interface between user and accelerator lattice.

Property	Type	Description
<i>RepeatModule2</i>	bool	Set to 1 to enable repeats in this module.
<i>NumberOfRepeats</i>	int	Number of times the module will be repeated in addition to the initial placement.

8.5 Beam Definition and Beam Envelopes

The Optics application can be used to track a trajectory and associated beam envelope through the accelerator structure. Optics works by finding the Jacobian around some arbitrary trajectory using a

numerical differentiation. This is used to define a linear mapping about this trajectory, which can then be used to transport the beam envelope.

A beam envelope is defined by a reference trajectory and a beam ellipse. The reference trajectory takes its position and direction from the position and rotation of the module. If no rotation is defined the reference trajectory is taken along the z-axis. The magnitude of the momentum and the initial time of the reference trajectory is defined by properties. RF cavities are phased using the reference trajectory defined here.

The beam ellipse is represented by a matrix, which can either be set using

- Twiss-style parameters in (x, px) , (y, py) and (t, E) spaces.
- Twiss-style parameters in (t, E) space and Penn-style parameters in a cylindrically symmetric (x, px, y, py) space.
- A 6x6 beam ellipse matrix where the ellipse equation is given by $\mathbf{X.T()MX} = 1$.

The Penn ellipse matrix is given by

$$M = \begin{pmatrix} \epsilon_L mc \frac{\beta_L}{p} & -\epsilon_L mc \alpha_L & 0 & 0 & 0 & 0 \\ & \epsilon_L mc \gamma_L p & \frac{D_x}{E} V(E) & \frac{D'_x}{E} V(E) & \frac{D_y}{E} V(E) & \frac{D'_y}{E} V(E) \\ & & \epsilon_T mc \frac{\beta_T}{p} & -\epsilon_T mc \alpha_T & 0 & -\epsilon_T mc (\frac{q}{2} \beta_T \frac{B_z}{P} - L) \\ & & & \epsilon_T mc \gamma_T p & \epsilon_T mc (\frac{q}{2} \beta_T \frac{B_z}{P} - L) & 0 \\ & & & & \epsilon_T mc \frac{\beta_T}{p} & -\epsilon_T mc \alpha_T \\ & & & & & \epsilon_L mc \gamma_T p \end{pmatrix}$$

Here L is a normalised canonical angular momentum, q is the reference particle charge, B_z is the nominal on-axis magnetic field, p is the reference momentum, m is the reference mass, ϵ_T is the transverse emittance, β_T and α_T are the transverse Twiss-like functions, ϵ_L is the longitudinal emittance and β_L and α_L are the longitudinal Twiss-like functions. Additionally D_x , D_y , D'_x and D'_y are the dispersions and their derivatives with respect to z and $V(E)$ is the variance of energy (given by the (2,2) term in the matrix above).

The Twiss ellipse matrix is given by

$$M = \begin{pmatrix} \epsilon_L mc \frac{\beta_L}{p} & -\epsilon_L mc \alpha_L & 0 & 0 & 0 & 0 \\ & \epsilon_L mc \gamma_L p & \frac{D_x}{E} V(E) & \frac{D'_x}{E} V(E) & \frac{D_y}{E} V(E) & \frac{D'_y}{E} V(E) \\ & & \epsilon_x mc \frac{\beta_x}{p} & -\epsilon_x mc \alpha_x & 0 & 0 \\ & & & \epsilon_x mc \gamma_x p & 0 & 0 \\ & & & & \epsilon_y mc \frac{\beta_y}{p} & -\epsilon_y mc \alpha_y \\ & & & & & \epsilon_y mc \gamma_y p \end{pmatrix}$$

Here p is the reference momentum, m is the reference mass, e_i , b_i and a_i are the emittances and Twiss functions in the (t,E) , (x,p_x) and (y,p_y) planes respectively, D_x , D_y , D'_x , D'_y are the dispersions and their derivatives with respect to z and $V(E)$ is the variance of energy (given by the (2,2) term in the matrix above).

Property	Type	Description
<i>EnvelopeType</i>	string	Set to <i>TrackingDerivative</i> to evolve a beam envelope in the Optics application.
<i>BeamType</i>	string	Set to <i>Random</i> to generate a beam using the parameters below for the Simulation application. Set to <i>Pencil</i> to generate a pencil beam (with no random distribution). Set to <i>ICOOOL</i> , <i>Turtle</i> , <i>MAUS_PrimaryGenHit</i> or <i>G4BeamLine</i> to use a beam file.

Property	Type	Description
<i>Pid</i>	int	The particle ID of particles in the envelope or beam.
<i>Time</i>	double	Set the time of the envelope reference trajectory
<i>Longitudinal Variable</i>	string	Set the longitudinal variable used to define the reference trajectory momentum. Options are <i>Energy</i> , <i>KineticEnergy</i> , <i>Momentum</i> and <i>ZMomentum</i> .
Energy	double	Define the value of the longitudinal variable used to calculate the mean momentum and energy. The usual relationship $E^2 + p^2 c^2 = m^2 c^4$ applies. Kinetic energy E_k is related to energy E by $E_k + m = E$.
KineticEnergy	double	
Momentum	double	
ZMomentum	double	
<i>EllipseDefinition</i>	string	Define the beam ellipse that will be used in calculating the evolution of the Envelope, or used to generate a beam for Beam-Type <i>Random</i> . Options are <i>Twiss</i> , <i>Penn</i> and <i>Matrix</i> .
<i>The following properties are only used if EllipseDefinition is set to Twiss</i>		
<i>Emittance_X</i>	double	Emittance in each 2d subspace, (x,px), (y,py) and (t,E).
<i>Emittance_Y</i>	double	
<i>Emittance_L</i>	double	
<i>Beta_X</i>	double	Twiss b function in each 2d subspace, (x,px), (y,py) and (t,E).
<i>Beta_Y</i>	double	
<i>Beta_L</i>	double	
<i>Alpha_X</i>	double	Twiss a function in each 2d subspace, (x,px), (y,py) and (t,E).
<i>Alpha_Y</i>	double	
<i>Alpha_L</i>	double	
<i>The following properties are only used if EllipseDefinition is set to Matrix</i>		
<i>Covariance(t,t)</i>	double	Set the 6x6 matrix that will be used in the to define the beam ellipse. Covariances should be covariances of elements of the matrix (x,Px,y,Py,t,E). This must be a positive definite matrix, i.e. determinant > 0. Note that this means that at least the 6 terms on the diagonal must be defined. Other terms default to 0.
<i>Covariance(t,E)</i>	double	
<i>Covariance(t,x)</i>	double	
...	double	
<i>Covariance(Py,Py)</i>	double	
<i>The following properties are only used if EllipseDefinition is set to Penn</i>		
<i>Emittance_T</i>	double	Transverse emittance for the 4d (x,px,y,py) subspace.
<i>Emittance_L</i>	double	Longitudinal emittance for the 2d (t,E) subspace.
<i>Beta_T</i>	double	Transverse beta for the 4d (x,px,y,py) subspace.
<i>Beta_L</i>	double	Longitudinal beta for the 2d (t,E) subspace.
<i>Alpha_T</i>	double	Transverse alpha for the 4d (x,px,y,py) subspace.
<i>Alpha_L</i>	double	Longitudinal alpha for the 2d (t,E) subspace.
<i>Normalised AngularMomentu</i>	double	Normalised angular momentum for the transverse phase space.
Bz	double	Nominal magnetic field on the reference particle.
<i>The following properties are used if EllipseDefinition is set to Penn or Twiss</i>		
<i>Dispersion_X</i>	double	Dispersion in x (x-energy correlation).
<i>Dispersion_Y</i>	double	Dispersion in y (y-energy correlation).
<i>DispersionPrime_X</i>	double	D' in x (Px-energy correlation).
<i>DispersionPrime_Y</i>	double	D' in y (Py-energy correlation).
<i>The following properties are only relevant for generating a beam envelope</i>		
RootOutput	string	Output file name for writing output beam envelope in ROOT binary format.
LongTextOutput	string	Output file name for writing output beam envelope in string format.
ShortTextOutput	string	Output file name for writing output beam envelope in string format. This abbreviated output omits some of the fields that are present in LongTextOutput files.

Property	Type	Description
BeamOutput	string	If a BeamType is defined, this property controls the file name to which beam data is written.
Delta_t	double	Offset in time used for calculating numerical derivatives. Default is 0.1 ns.
Delta_E	double	Offset in energy used for calculating numerical derivatives. Default is 1 MeV.
Delta_x	double	Offset in x position used for calculating numerical derivatives. Default is 1 mm.
Delta_Px	double	Offset in x momentum used for calculating numerical derivatives. Default is 1 MeV/c.
Delta_y	double	Offset in y position used for calculating numerical derivatives. Default is 1 mm.
Delta_Py	double	Offset in y momentum used for calculating numerical derivatives. Default is 1 MeV/c.
Max_Delta_t	double	Maximum offsets when polyfit algorithm is used. In some cases the offset can keep increasing without limit unless these maximum offsets are defined. Default is no limit.
Max_Delta_E	double	
Max_Delta_x	double	
Max_Delta_Px	double	
Max_Delta_y	double	
Max_Delta_Py	double	
<i>The following properties are only relevant for generating a particle beam</i>		
UseAsReference	Bool	If set to true and the datacard <i>FirstParticleIsReference</i> is set to 0, the first event in the Module will be used as the reference particle that sets cavity phases. This particle will then have the mean trajectory (i.e. no gaussian distribution).
<i>BeamFile</i>	string	If the BeamType is <i>ICool</i> , <i>Turtle</i> , <i>MAUS_PrimaryGenHit</i> or <i>G4BeamLine</i> , this property defines the name of the file containing tracks for MAUS.
NumberOfEvents	int	Set the maximum number of events to take from this module. If other modules are defined, MAUS will iterate over the modules until it the datacard <i>numEvs</i> is reached or all modules have been run to <i>NumberOfEvents</i> . Default is for MAUS to keep tracking from the first module it finds until <i>numEvs</i> is reached.

8.6 Optimiser

It is possible to define an optimiser for use in the Optics application. The optimiser enables the user to vary parameters in the MiceModule file and try to find some optimum setting. For each value of the parameters, MAUS Optics will calculate a score; the optimiser attempts to find a minimum value for this score.

Property	Type	Description
<i>Optimiser</i>	string	Controls the function used for optimising. For now Minuit is the only available option.
<i>Algorithm</i>	string	For <i>Minuit</i> optimiser, controls the <i>Minuit</i> algorithm used. In general Simplex is a good option to use here. An alternative is Migrad. See Minuit documentation (for example at http://root.cern.ch/root/html/TMinuit.html) for further information. Minuit attempts to minimise the score function defined by the Score properties.

Property	Type	Description
<i>NumberOfTries</i>	int	Maximum number of iterations MAUS will make in order to find the optimum value.
<i>StartError</i>	double	Guess at the initial error in the score.
<i>EndError</i>	double	Required final error in the score for the optimisation to converge successfully.
RebuildSimulation	bool	Set to False to tell MAUS not to rebuild the simulation on each iteration. This should be used to speed up the optimiser when a parameter is used that does not change the field maps. Default is true.
<i>Parameter1_Start</i>	double	Seed value for the parameter, that is used in the first iteration.
<i>Parameter1_Name</i>	string	Name of the parameter. This name is used as an expression substitution variable elsewhere in the code and should start with @. See Expression Substitutions above for details on usage of expression substitutions.
Parameter1_Delta	double	Estimated initial error on the parameter. Default is 1.
Parameter1_Fixed	bool	Set to true to fix the parameter (so that it is excluded from the optimisation). Default is false.
Parameter1_Min	double	If required, set to the minimum value that the parameter can hold.
Parameter1_Max	double	If required, set to the maximum value that the parameter can hold.
Parameter2_Start	...	Define an arbitrary number of parameters. Parameters must be numbered consecutively, and each parameter must have at least the start value and name defined. The optimiser will attempt to optimise against a score that is calculated by summing the Score1, Score2,... parameters on each iteration.
...	...	
Parameter2_Max	...	
<i>Score1</i>	double	
Score2	...	
...	...	

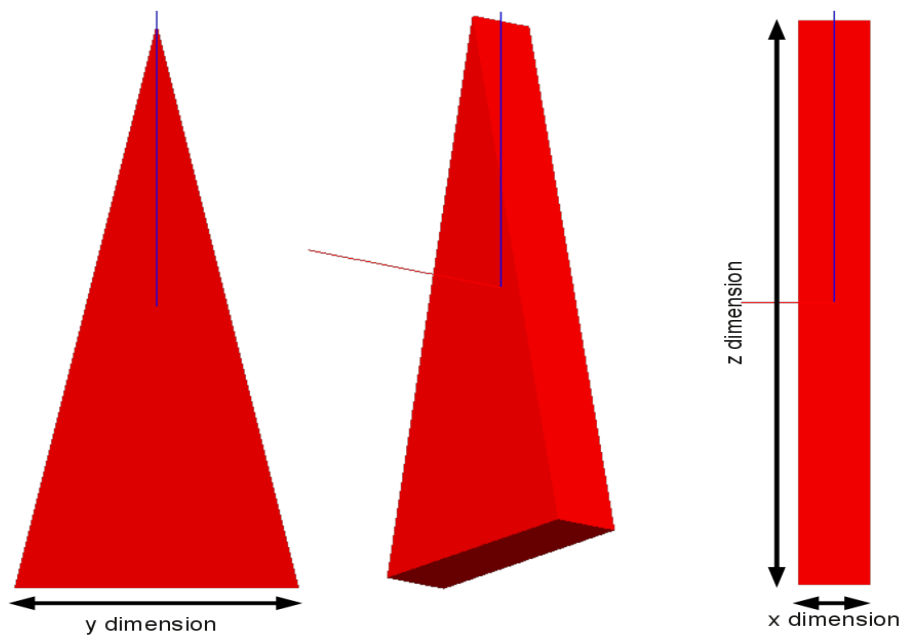

Figure 8.1: Schematic of the geometry of a Wedge volume.

Chapter 9

Field Properties

Invoke a field using `PropertyString FieldType <fieldtype>`. The field will be placed, normally centred on the `MiceModule` Position and with the appropriate Rotation. Further options for each field type are specified below, and relevant datacards are also given. If a fieldtype is specified some other properties must also be specified, while others may be optional, usually taking their value from defaults specified in the datacards. Only one fieldtype can be specified per module. However, fields from multiple modules are superimposed, each transformed according to the `MiceModule` specification. This enables many different field configurations to be simulated using MAUS.

To use BeamTools fields, datacard `FieldMode Full` must be set. This is the default.

Property	Type	Description
<i>FieldType</i>	string	Set the field type of the <code>MiceModule</code> .

9.0.1 FieldType CylindricalField

Sets a constant magnetic field in a cylindrical region symmetric about the z-axis of the module.

Property	Type	Description
<i>ConstantField</i>	Hep3 Vector	The magnetic field that will be placed in the region.
<i>Length</i>	double	The physical extent of the region.
<i>FieldRadius</i>	double	

9.0.2 FieldType RectangularField

Sets a constant magnetic field in a rectangular region.

Property	Type	Description
<i>ConstantField</i>	Hep3 Vector	The magnetic field that will be placed in the region.
<i>Length</i>	double	The physical extent of the region.
<i>Width</i>	double	
<i>Height</i>	double	

9.0.3 FieldType Solenoid

MAUS simulates solenoids using a series of current sheets. The field for each solenoid is written to a field map on a rectangular grid and can then be reused. The field from each current sheet is calculated using the formula for current sheets detailed in MUCOOL Note 281, *Modeling solenoids using coil, sheet and block conductors*.

Property	Type	Description
<i>FileName</i>	string	Read or write solenoid data to the filename. If different modules have the same filename, MAUS assumes they are the same.
FieldMapMode	string	If set to Read, MAUS will attempt to read existing data from the FileName. If set to Write, MAUS will generate new data and write it to the FileName. If set to Analytic, MAUS will calculate fields directly without interpolating. If set to WriteDynamic acts as in Write except the grid extent and grid spacing at each point is chosen dynamically to some tolerance defined in the FieldTolerance property. Takes default from datacard SolDataFiles (Write).
<i>Length</i>	double	Coil physical parameters. Only used in Write/Analytic mode where they are mandatory.
<i>Thickness</i>	double	
<i>InnerRadius</i>	double	
CurrentDensity	double	The current density of the solenoid, in A/mm^2 .
Current	double	The current in the solenoid coil; the CurrentDensity is calculated from current I , number of turns n , length l and thickness t using $J = nI/(lt)$. If CurrentDensity is also defined, it overrides any Current setting.
NumberOfTurns	int	The total number of turns in the coil (see Current for more information).
ZExtentFactor	double	Field map extends to length + ZExtentFactor*innerRadius in Write mode. Takes default from datacard SolzMapExtendFactor (10.). Map size is chosen dynamically in WriteDynamic mode.
RExtentFactor	double	Field map extends to radius RExtentFactor*innerRadius in Write mode. Takes default from datacard SolrMapExtendFactor (2.018...). Avoid allowing grid nodes to fall on sheets.
NumberOfZCoords	int	Number of coordinates in z in field map grid in Write mode. Takes default from datacard NumberNodesZGrid (500).
NumberOfRCoords	int	Number of coordinates in r in field map grid in Write mode. Takes default from datacard NumberNodesRGrid (100).
NumberOfSheets	int	Number of sheets used to calculate the field. Takes default from datacard DefaultNumberOfSheets (10).
<i>FieldTolerance</i>	double	Mandatory when FieldMapMode is WriteDynamic. If field map mode is write dynamic, this datacard controls the tolerance on errors in the field with which the field grid and the grid extent will be chosen.
Interpolation Algorithm	string	Choose the interpolation algorithm. Options are BiLinear for a linear interpolation in r and z , or LinearCubic for a linear interpolation in r and a cubic spline in z . Default is LinearCubic.
IsAmalgamated	bool	Set to 1 to add the coil to CoilAmalgamation parent field (see below).

9.0.4 FieldType FieldAmalgamation

During tracking, MAUS stores a list of fields and for each one MAUS checks to see if tracking is performed through a particular field map's bounding box. This can be slow if a large number of fields are present. One way to speed this up is to store contributions from many coils in a single CoilAmalgamation. A CoilAmalgamation searches through child modules for solenoids with PropertyBool IsAmalgamated set to true. If it finds such a coil, it will add the field generated by the solenoid to its own field map and disable the coil.

Property	Type	Description
<i>Length</i>	double	The Length of the field map generated by the CoilAmalgamation.
<i>RMax</i>	double	The maximum radius of the field map generated by the CoilAmalgamation.
Interpolation Algorithm	string	Choose the interpolation algorithm. Options are BiLinear for a linear interpolation in r and z , or LinearCubic for a linear interpolation in r and a cubic spline in z . Default is LinearCubic.

Property	Type	Description
<i>ZStep</i>	double	Step size of the field map generated by the CoilAmalgamation.
<i>RStep</i>	double	

9.0.5 FieldType DerivativesSolenoid

This is an alternative field model for solenoids that uses a power law expansion of the on-axis magnetic field and its derivatives, and an exponential fall-off for the fringe field. The fringe field is defined in the same way as other end fields, but note that HardEdged end field type is not available for solenoids and will result in an error.

Property	Type	Description
<i>PeakField</i>	double	Nominal peak field of the solenoid.
<i>ZMax</i>	double	Maximum z-half length of the solenoid bounding box in the local coordinate system of the magnet.
<i>RMax</i>	double	Maximum radius of the solenoid bounding box in the local coordinate system of the magnet.
<i>MaxEndPole</i>	int	Maximum derivative used in calculating the end field of the solenoid.

9.0.6 Phasing Models

MAUS has a number of models for phasing RF cavities.

When CavityMode is Unphased, MAUS attempts to phase the cavity itself. When using CavityMode Unphased MAUS needs to know when particles enter, cross the middle, and leave cavities. To phase a cavity, MAUS builds a virtual detector in the centre of the cavity that is used for phasing and then fires a reference particle through the system. Stochastic processes are always disabled during this process, while mean energy loss can be disabled using the datacard ReferenceEnergyLossModel. If a reference particle crosses a plane through the centre of a cavity, it sets the phase of the cavity to the time at which the particle crosses.

The field of the cavity during phasing is controlled by the property FieldDuringPhasing. There are four modes:

- *None*: Cavity fields are disabled during phasing
- *Electrostatic*: An electrostatic field with no positional dependence given by $PeakField * \sin(ReferenceParticlePhase)$ is enabled during phasing.
- *TimeVarying*: A standard time varying field is applied during phasing, initially with arbitrary phase relative to the reference particle. MAUS uses a Newton-Raphson method to find the appropriate reference phase iteratively, with tolerance set by the datacard PhaseTolerance.
- *EnergyGainOptimised*: A standard time varying field is applied during phasing, initially with arbitrary phase and peak field relative to the reference particle. MAUS uses a 2D Newton-Raphson method to find the appropriate reference phase and peak field iteratively, so that the reference particle crosses the cavity centre with phase given by property ReferenceParticlePhase and gains energy over the whole cavity given by property EnergyGain with tolerances set by the datacards PhaseTolerance and RFDeltaEnergyTolerance.

9.0.7 Tracking Stability Around RF Cavities

Usually RF cavities have little or no fringe field, and this can lead to some instability in the tracking algorithms. When MAUS makes a step into an RF cavity volume, the tracking algorithms tend to smooth out a field in a non-physical way. This can be prevented by either (i) making the step size rather small in the RF cavity or (ii) forcing MAUS to stop tracking by adding a physical volume at the entrance of the RF cavity (a window, typically made of vacuum). Doing this should improve stability of tracking.

9.0.8 FieldType PillBox

Sets a PillBox field in a particular region. MAUS represents pillboxes using a sinusoidally varying TM010 pill box field, with non-zero field vector elements given by

$$B_\phi = J_1(k_r r) \cos(\omega t)$$

$$E_z = J_0(k_r r) \cos(\omega t)$$

Here J_n are Bessel functions and k_r is a constant. See, for example, SY Lee VI.1. All other fields are 0.

Property	Type	Description
<i>Length</i>	double	Length of the region in which the field is present.
<i>CavityMode</i>	string	Phasing mode of the cavity - options are Phased, Unphased and Electrostatic.
<i>FieldDuringPhasing</i>	string	Controls the field during cavity phasing – options are None, Electrostatic, TimeVarying and EnergyGainOptimised.
<i>EnergyGain</i>	double	WhenFieldDuringPhasing is set to EnergyGainOptimised, controls the peak electric field.
<i>Frequency</i>	double	The cavity frequency.
<i>PeakEField</i>	double	The peak field of the cavity. Not used when the FieldDuringPhasing is EnergyGainOptimised.
<i>TimeDelay</i>	double	In Phased mode the time delay (absolute time) of the cavity.
PhasingVolume	string	Set to SpecialVirtual to make the central volume a special virtual.
ReferenceParticle Energy	double	In Electrostatic mode, MAUS calculates the peak field and the field the reference particle sees using a combination of the reference particle energy, charge and phase. Take defaults from datacards NominalKineticEnergy and MuonCharge
ReferenceParticle Charge	double	
ReferenceParticle Phase	double	MAUS tries to phase the field so that the reference particle crosses the cavity at ReferenceParticlePhase (units are angular). 0° corresponds to no energy gain, 90° corresponds to operation on-crest. Default from datacard rfAccelerationPhase.

9.0.9 FieldType RFFieldMap

Sets a cavity with an RF field map in a particular region. RFFieldMap uses the same phasing algorithm as described above.

Property	Type	Description
<i>Length</i>	double	Length of the region in which the field is present.
<i>CavityMode</i>	string	Phasing mode of the cavity - options are Phased and Unphased. RFFieldMaps cannot operated in Electrostatic mode.
<i>FieldDuringPhasing</i>	string	Controls the field during cavity phasing – options are None, Electrostatic, TimeVarying and EnergyGainOptimised.
<i>EnergyGain</i>	double	WhenFieldDuringPhasing is set to EnergyGainOptimised, controls the peak electric field.
<i>Frequency</i>	double	The cavity frequency.
<i>PeakEField</i>	double	The peak field of the cavity. Not used when the FieldDuringPhasing is EnergyGainOptimised.
<i>TimeDelay</i>	double	In Phased mode the time delay (absolute time) of the cavity.
PhasingVolume	string	Set to SpecialVirtual to make the central volume a special virtual.
ReferenceParticle Energy	double	In Electrostatic mode, MAUS calculates the peak. field and the field the reference particle sees using a combination of the reference particle energy, charge and phase. Take defaults from datacards NominalKineticEnergy and MuonCharge
ReferenceParticle Charge	double	

Property	Type	Description
ReferenceParticlePhase	double	MAUS tries to phase the field so that the reference particle crosses the cavity at ReferenceParticlePhase (units are angular). 0° corresponds to no energy gain, 90° corresponds to operation on-crest. Default from datacard rfAccelerationPhase.
FileName	string	The file name of the field map file.
FileType	string	The file type of the field map. Only supported option is SuperFishSF7.

9.0.10 FieldType Multipole

Creates a multipole of arbitrary order. Fields are generated using either a hard edged model, with no fringe fields at all; or an Enge model similar to ZGoubi and COSY. In the former case fields are calculated using a simple polynomial expansion. In the latter case fields are calculated using the polynomial expansion with an additional exponential drop off. Fields can be superimposed onto a bent coordinate system to generate a sector multipole with arbitrary fixed radius of curvature.

Unlike most other field models in MAUS, the zero position corresponds to the center of the entrance of the multipole; and the multipole extends in the +z direction.

The method to define end fields is described in the section EndFieldTypes below

Property	Type	Description
Pole	int	The reference pole of the magnet. 1=dipole, 2=quadrupole, 3=sextupole etc.
FieldStrength	double	Scale the field strength in the good field region. For dipoles, this sets the dipole field; for quadrupoles this sets the field gradient. Note that for some end field settings there can be no good field region (e.g. if the end length is > ~ centre length).
Height	double	Height of the field region.
Width	double	Width or delta radius of the field region.
Length	double	Length of the field along the bent trajectory.
EndFieldType	string	Set to HardEdged to disable fringe fields. Set to Enge or Tanh to use those models, as described elsewhere. Default is HardEdged.
CurvatureModel	string	Choose the model for curvature. Straight forces no curvature. Constant gives a constant radius of curvature; StraightEnds gives a constant radius of curvature along the length of the multipole with straight end fields beyond this length. MomentumBased gives radius of curvature determined by a momentum and a total bending angle.
ReferenceCurvature	double	Radius of curvature of the magnet in Constant or StraightEnds mode. Set to 0 for a straight magnet. Default is 0.
ReferenceMomentum	double	Reference momentum used to calculate the radius of curvature of a dipole in MomentumBased mode. Default is 0.
BendingAngle	double	The angle used to calculate the radius of curvature of a dipole in MomentumBased mode. Note that this is mandatory in MomentumBased mode.

9.0.11 FieldType CombinedFunction

This creates superimposed dipole, quadrupole and sextupole fields with a common radius of curvature. The field is intended to mimic the first few terms in a multipole expansion of a field like

$$B(y = 0) = B_0 \left(\frac{r}{r_0} \right)^k$$

The field index is a user defined parameter, while the dipole field and radius of curvature can either be defined directly by the user or defined in terms of a reference momentum and total bending angle. Fields are calculated as in the multipole field type defined above.

Property	Type	Description
<i>Pole</i>	int	The reference pole of the magnet. 1=dipole, 2=quadrupole, 3=sextupole etc.
<i>BendingField</i>	double	The nominal dipole field B_0 . Note that this is mandatory in all cases except where CurvatureModel is MomentumBased, when the BendingAngle and ReferenceMomentum is used to calculate the dipole field instead.
<i>FieldIndex</i>	double	The field index k .
<i>Height</i>	double	Height of the field region.
<i>Width</i>	double	Width or delta radius of the field region.
<i>Length</i>	double	Length of the field along the bent trajectory.
EndFieldType	string	Set to HardEdged to disable fringe fields. Set to Enge or Tanh to use those models, as described elsewhere. Default is HardEdged.
CurvatureModel	string	Choose the model for curvature. Straight forces no curvature. Constant gives a constant radius of curvature; StraightEnds gives a constant radius of curvature along the length of the multipole with straight end fields beyond this length. MomentumBased gives radius of curvature determined by a momentum and a total bending angle.
ReferenceCurvature	double	Radius of curvature of the magnet in Constant or StraightEnds mode. Set to 0 for a straight magnet. Default is 0.
ReferenceMomentum	double	Reference momentum used to calculate the radius of curvature of a dipole in MomentumBased mode. Default is 0.
<i>BendingAngle</i>	double	The angle used to calculate the radius of curvature of a dipole in MomentumBased mode. Note that this is mandatory in MomentumBased mode.

9.0.12 EndFieldTypes

In the absence of current sources, the magnetic field can be calculated from a scalar potential using the standard relation

$$\vec{B} = \nabla V_n$$

The scalar magnetic potential of the n^{th} -order multipole field is given by

$$V_n = \sum_{q=0}^{q_m} \sum_{m=0}^n n!^2 \frac{G^{(2q)}(s)(r^2 + y^2)^q \sin(\frac{m\pi}{2})r^{n-m}y^m}{4^q q!(n+q)!m!(n-m)!}$$

where $G(s)$ is either the double Enge function,

$$G(s) = E[(x - x_0)/\lambda] + E[(-x - x_0)/\lambda] - 1$$

$$E(s) = \frac{B_0}{R_0^n} \frac{1}{1 + \exp(C_1 + C_2 s + C_3 s^2 + \dots)}$$

or $G(s)$ is the double tanh function,

$$G(s) = \tanh[(x + x_0)/\lambda]/2 + \tanh[(x - x_0)/\lambda]/2$$

and (r, y, s) is the position vector in the rotating coordinate system. Note that here s is the distance from the nominal end of the field map.

Property	Type	Description
EndFieldType	string	Set to HardEdged to disable fringe fields. Set to Enge or Tanh to use those models, as described elsewhere. Default is HardEdged.
<i>The following properties are used for EndFieldType Tanh</i>		
EndLength	double	Set the l parameter that defines the rapidity of the field fall off.
CentreLength	double	Set the x_0 parameter that defines the length of the flat field region.
MaxEndPole	int	Set the maximum pole that will be calculated – should be larger than the multipole pole.

Property	Type	Description
<i>The following properties are used for EndFieldType Enge</i>		
EndLength	double	Set the l parameter that defines the rapidity of the field fall off.
CentreLength	double	Set the x_0 parameter that defines the length of the flat field region.
MaxEndPole	int	Set the maximum pole that will be calculated – should be larger than the multipole pole.
Enge1	double	Set the parameters C_i as defined in the Enge function above.
Enge2	double	
...	double	
EngeN	double	

9.0.13 FieldType MagneticFieldMap

Reads or writes a magnetic field map in a particular region. Two sorts of field maps are supported; either a 2d field map, in which cylindrical symmetry is assumed, or a 3d field map.

For 2d field maps, MAUS reads or writes a file that contains information about the radial and longitudinal field components. This is intended for solenoidal field maps where only radial and longitudinal field components are present. Note that in write mode, MAUS assumes cylindrical symmetry of the fields. In this case, MAUS writes the x and z components of the magnetic field at points on a grid in x and z . Fields with an electric component are excluded from this summation.

For 3d field maps, MAUS reads a file that contains the position and field in cartesian coordinates and performs a linear interpolation. This requires quite large field map files; the file size can be slightly reduced by using certain symmetries, as described below. It is currently not possible to write 3d field maps.

Property	Type	Description
<i>FieldMapMode</i>	string	Set to Read to read a field map; and Write to write a field map.
<i>FileName</i>	string	The file name that is used for reading or writing.
FileType	string	The file format. Supported options in Read mode are MAUS <i>text</i> , MAUS <i>binary</i> , g4beamline, icool, g4bl3dGrid. Only MAUS <i>text</i> is supported in Write mode. Default is MAUS <i>text</i> .
Symmetry	string	Symmetry option for g4bl3dGrid file type. Options are None, Dipole or Quadrupole. None uses the field map as is, while Dipole and Quadrupole reflect the octant between the positive x , y and z axes to give an appropriate field for a dipole or quadrupole.
<i>ZStep</i>	double	Step size in z and r . Mandatory in Write mode but not used in Read mode (where step size comes from the map file).
<i>RStep</i>	double	
<i>ZMin</i>	double	Upper and lower bounds in z and r . Mandatory in Write mode but not used in Read mode (where boundaries come from the map file).
<i>ZMax</i>	double	
<i>RMin</i>	double	
<i>RMax</i>	double	

Some file formats are described below. I am working towards making the file format more generic and hence possibly easier to use, but backwards compatibility will hopefully be maintained.

MAUS*text* Field Map Format

The native field map format used by MAUS in text mode is described below.

```
# GridType = Uniform N = number_rows
# Z1 = z_start Z2 = z_end dZ = z_step
# R1 = r_start R2 = r_end dR = r_step
Bz_Values Br_Values
...
<Repeat as necessary>
```

In this mode, field maps are represented by field values on a regular 2d grid that is assumed to have solenoidal symmetry, i.e. cylindrical symmetry with no tangential component.

Name	Type	Description
number_rows	double	Number of rows in the field map file.
z_start	double	Position of the grid start along the z axis.
z_end	double	Position of the grid end along the z axis.
z_step	double	Step size in z .
r_start	double	Position of the grid start along the r axis.
r_end	double	Position of the grid end along the r axis.
r_step	double	Step size in r .
Bz_Values	double	Bz field value.
Br_Values	double	Br field value.

g4bl3dGrid Field Map Format

The file format for 3d field maps is a slightly massaged version of a file format used by another code, g4beamline. In this mode, field maps are represented by field values on a regular cartesian 3d grid.

```

number_x_points number_y_points number_z_points global_scale
  1 X [x_scale]
  2 Y [y_scale]
  3 Z [z_scale]
  4 BX [bx_scale]
  5 BY [by_scale]
  6 BZ [bz_scale]
  0
  X_Values  Y_Values  Z_Values  Bx_values  By_values  Bz_values
  ...      ...      ...      ...      ...      ...
<Repeat as necessary>

```

where text in bold indicates a value described in the following table

Name	Type	Description
number_x_points	double	Number of points along x axis.
number_y_points	double	Number of points along y axis.
number_z_points	double	Number of points along z axis.
global_scale	double	Global scale factor applied to all x, y, z and Bx, By, Bz values.
x_scale	double	Scale factor applied to all x values.
y_scale	double	Scale factor applied to all y values.
z_scale	double	Scale factor applied to all z values.
bx_scale	double	Scale factor applied to all Bx values.
by_scale	double	Scale factor applied to all By values.
bz_scale	double	Scale factor applied to all Bz values.
X_Values	double	List (column) of each x value.
Y_Values	double	List (column) of each y value.
Z_Values	double	List (column) of each z value.
Bx_Values	double	List (column) of each Bx value.
By_Values	double	List (column) of each By value.
Bz_Values	double	List (column) of each Bz value.

Chapter 10

TOF Detector

This chapter describes the time-of-flight (TOF) simulation and reconstruction software. The simulation is designed to produce digits similar to “real data” and the reconstruction is agnostic about whether the digits are from simulation or data acquisition.

10.1 Simulation

- **Geometry**

For the most upstream TOF – TOF0 – to be simulated, it is essential that the z where the beam starts be upstream of the detector.

In the standard Step VI geometry as described in `Stage6.dat`, this is at -14200 mm and for the Step IV geometry described in `Stage4.dat` it is at 2773 mm

The internal geometry of the TOF detector and the positioning of the slabs are defined in the `MiceModules` representation . The numbering convention is the same as that for the DAQ and is described in MICE-Notes 251 and 286. It is worth keeping in mind the plane numbering convention since the current naming scheme is suboptimal:

- `station` refers to the TOF station – TOF0, TOF1, TOF2
- `plane` refers to the horizontal/vertical planes within a station
- `plane 0` means horizontal slabs – slabs are oriented horizontally. They measure y
- `plane 1` means vertical slabs – slabs are oriented vertically. They measure x

The z locations of TOF0 and TOF1 are specified in the `Beamline.dat` file and the z of TOF2 is specified in the main geometry description file, for e.g. `Stage6.dat`

- **Hits**

GEANT hits are generated for all tracks which pass through a TOF slab. “True” TOF hits are described by the `MAUS::Hit` class and contain the GEANT4 information prior to digitization. The members of the class are listed below.

10.1.1 Digitization

Each GEANT hit in the TOF is associated with a slab based on the geometry described in the TOF `MiceModules`. If a hit’s position does not correspond to a physical slab (for instance if the hit is outside the fiducial volume) the hit is not digitized. The energy deposited in the slab and the hit time are then digitized as described below.

- **Charge digitization** The energy deposited by a hit in a slab is first converted to units of photoelectrons. The photoelectron yield from a hit is attenuated by the distance from the hit to the PMT, then smeared by the photoelectron resolution. The yields from all hits in a given slab are then added and the summed photoelectron yield is converted to ADC (In principle, this should be done not on an event-by-event basis but rather on a trigger-basis. In the absence of a real trigger, all hits in a slab are now merged)

Table 10.1: True TOF hit class members.
The GEANT TOF hits are encoded with the following information.

Name	Meaning
channel_id	Class <code>TOFChannelId*</code> contains <code>station,plane,slab</code>
energy_deposited	double – energy deposited by track in the slab
position	<code>ThreeVector</code> – x, y, z of hit at the slab
momentum	<code>ThreeVector</code> – p_x, p_y, p_z of particle at slab
time	double – hit time
charge	double – PDG charge of particle that produced this hit
track_id	<code>G4Track</code> – ID of the GEANT track that produced this hit
particle_id	<code>ThreeVector</code> – PDG code of the particle that produced this hit

Table 10.2: Data cards for TOF digitization.

Name	Meaning	Default
<code>TOFconversionFactor</code>	conversion	0.005 MeV
<code>TOFpmtTimeResolution</code>	resolution for smearing the PMT time	0.1 ns
<code>TOFattenuationLength</code>	light attenuation in slabs	1400 mm
<code>TOFadcConversionFactor</code>	conversion from charge to ADC	0.125
<code>TOFtdcConversionFactor</code>	conversion from time to TDC	0.025
<code>TOFpmtQuantumEfficiency</code>	PMT collection efficiency	0.25
<code>TOFscintLightSpeed</code>	propagation speed in slab	170 mm/ns

- **Time digitization** The hit time is propagated to the PMTs at either end of the slab. The speed of light in the scintillator, based on earlier calibration, is controlled by the `TOFscintLightSpeed` data card. The time is then smeared by the PMT time resolution and converted to TDC.

After converting the energy deposit to ADC and the time to TDC, the TDC values are “uncalibrated” so that at the reconstruction stage they can be corrected just as is done with real data.

The data cards that control the digitization are listed in Table 9.2.

NOTE: Do not modify the default values.

10.2 Reconstruction

The reconstruction software treats both data and Monte Carlo the same way. In the case of real data, the input to the reconstruction chain is TOF Digits (`MapCppTOFDigit`) and in the case of Monte Carlo it is the digitized information from `MapCppTOFMCDigitizer`.

- **Digits** (`MapCppTOFDigit,MapCppTOFMCDigitizer`) Digits are formed from the V1724 ADCs and V1290 TDCs.
- **Slab Hits** (`MapCppTOFSlabHits`) The `SlabHits` routine takes individual PMT digits and associates them to reconstruct the hit in the slab. All PMT digits are considered. If there are multiple hits associated with a PMT, the hit which is earliest in time is taken to be the real hit. Then, if both PMTs on a slab have hits, the `SlabHit` is formed. The TDC values are converted to time (`ToftdcConversionFactor`) and the hit time and charge associated with the slab hit are taken to be the average of the two PMT times and charges respectively. In addition, the charge product of the PMT charges is also formed.
- **Space Points** (`MapCppTOFSpacePoints`) A space point pixel in the TOF is a combination of x and y slab hits. All combinations of x and y slab hits in a given station are considered. If the station is a trigger station, an attempt is made to find the “trigger pixel” – i.e. the x, y combination that triggered this event. This is done by applying calibration corrections to the slab hits, and then asking if the average time in this pixel is consistent with the trigger within some tolerance. In other

Table 10.3: TOFSpacePoint class members.

Name	Meaning
pixel_key	string encoded with the TOF station,plane,slab
slabY	int encoded with the TOF station,plane,slab
slabX	int encoded with the TOF station,plane,slab
time	double – calibrated space point time
charge	int – average of the charges of the constituent slabs
charge_product	int – average of charge products of the constituent slabs
dt	double – time difference between the x and y slabs = resolution

Table 10.4: Data cards for TOF reconstruction.

Name	Meaning	Default
TOF_trigger_station	conversion	0.005 MeV
TOF_findTriggerPixelCut	resolution for smearing the PMT time	0.1 ns
TOF_makeSpacePiontCut	PMT collection efficiency	0.25
Enable_t0_correction	light attenuation in slabs	1400 mm
Enable_triggerDelay_correction	conversion from charge to ADC	0.125
Enable_timeWalk_correction	conversion from time to TDC	0.025

words, if t_x and t_y are the times corresponding to the x and y slab hits, is $\frac{t_{x,calib}+t_{y,calib}}{2} < t_{triggercut}$? If no x, y combination produces a trigger pixel, the space point reconstruction stops and no space points are formed. This is because to apply the calibration corrections to the slab hit times, it is essential know the trigger pixel.

Once a trigger pixel is found, all x, y slab hit combinations are again treated as space point candidates. The calibration corrections are applied to these hit times. If $|t_x - t_y|$ is consistent with the resolution of the detector, the combination is said to be a space point. The space point thus formed contains the following information

```
This is used by the reconstruction of the TOF detectors
#TOF_cabling_file = "/files/cabling/TOFChannelMap.txt"
#TOF_TW_calibration_file = "/files/calibration/tofcalibTW_dec2011.txt"
#TOF_T0_calibration_file = "/files/calibration/tofcalibT0_trTOF1_dec2011.txt"
#TOF_T0_calibration_file = "/files/calibration/tofcalibT0_trTOF0.txt"
#TOF_Trigger_calibration_file = "/files/calibration/tofcalibTrigger_trTOF1_dec2011.txt"
#TOF_Trigger_calibration_file = "/files/calibration/tofcalibTrigger_trTOF0.txt"
# the date for which we want the cabling and calibration
# date can be 'current' or a date in YYYY-MM-DD hh:mm:ss format
#TOF_calib_date_from = 'current'
TOF_calib_date_from = '2010-08-10 00:00:00'
TOF_cabling_date_from = 'current'
Enable_timeWalk_correction = True
Enable_triggerDelay_correction = True
Enable_t0_correction = True
```

10.3 Database

- Constants in the CDB
- Datacards
- Routines to access

Table 10.5: Data cards for accessing calibrations from CDB.

Name	Meaning	Default
T0F_calib_date_from	conversion	'2010-08-10 00:00:00'
T0F_cabling_date_from	conversion	current

Chapter 11

The Trackers

11.1 Introduction

11.1.1 Overview

This chapter describes the software used to simulate and reconstruct the MICE scintillating fibre trackers. Section 11.2, 11.3 and 11.4 are reference sections providing descriptions of the official definitions, reference surfaces and coordinate systems, and reconstruction algorithms respectively. The later sections provide descriptions of the code as implemented in MAUS. A quick start guide regular users appears in below in section 11.1.2.

11.1.2 Quick start guide

Example scripts and datacards for the tracker reconstruction can be found in the `bin/user/scifi` directory. A typical top level python file to run a simulation with tracker reconstruction is shown below.

```
import io # generic python library for I/O
import gzip # For compressed output # pylint: disable=W0611
import MAUS

def run():
    # This input generates empty spills,
    # to be filled by the beam maker later
    my_input = MAUS.InputPySpillGenerator()

    # The mappers for to set up the simulation
    my_map = MAUS.MapPyGroup()
    my_map.append(MAUS.MapPyBeamMaker()) # beam construction
    my_map.append(MAUS.MapCppSimulation()) # geant4 sim

    # The mappers for tracker MC digitisation and recon
    my_map.append(MAUS.MapCppTrackerMCDigitization())
    my_map.append(MAUS.MapCppTrackerRecon())

    # Specify config parameters via a datacard
    datacards = io.StringIO(u"")

    # The Pattern Recognition reducer to display tracks
    reducer = MAUS.ReduceCppPatternRecognition()

    # Output to ROOT file
    my_output = MAUS.OutputCppRoot()

    # The Go() drives all the components you pass in
    MAUS.Go(my_input, my_map, reducer, my_output, datacards)

if __name__ == '__main__':
    run()
```

Some important datacard parameters to consider when using the tracker software are:

- `SciFiPRHelicalOn` - set to True or False for helical pattern recognition
- `SciFiPRStraightOn` - set to True or False for straight pattern recognition
- `SciFiKalmanOn` - set to True or False for running the final track fit

11.2 Definitions

11.2.1 Labelling of upstream and downstream trackers

The official labels for the two trackers are:

$$\begin{aligned} \text{Upstream tracker} &\rightarrow \text{Tracker\#1} \\ \text{Downstream tracker} &\rightarrow \text{Tracker\#2} \end{aligned}$$

The internals of the code however will frequently refer to the upstream tracker as 0, and the downstream tracker as 1. In this document, we will use the official convention.

11.2.2 Station numbering

The tracker reference document defines the station “labelling” of the stations in relation to the focus-coil module that is immediately downstream of tracker 1 or, equivalently, immediately upstream of tracker 2. The station closest to the focus-coil module in question is labelled “1”. The label then increases such that station 5 is the station closest to the optical patch panel. The scheme is summarised in table 11.1 and figure 11.1.

Table 11.1: Station numbering scheme. The “label” of the stations that make up a MICE tracker runs from 1 to 5. The location of the station in relation to the patch panel and the absorber is reported in the column labelled “Location”.

Location	Label
Closest to absorber (furthest from patch panel)	1
	2
	3
	4
Furthest from absorber (closest to patch panel)	5

11.2.3 Doublet layer

Each station consists of three “doublet layers” of $350\ \mu\text{m}$ scintillating fibres glued onto a carbon-fibre station body. The doublet layers are labelled u (sometimes referred to also as x), w and v . The layers are arranged such that the fibres in one layer run at an angle of 120° to the fibres in each of the other layers as shown in figure 11.2a. The arrangement of the fibres within a doublet layer is shown in figure 11.2b. The configuration of the seven fibres ganged for readout via a single clear-fibre light-guide is also indicated.

Doublet-layer numbering

The order in which the doublet layers were glued onto the station body is shown in figure 11.3. The u layer was glued to the station body first. The doublet layer was glued such that the “fibre side” of the doublet layer was glued to the station body; i.e. the mylar sheet faces away from the station body. The w layer was then glued onto the outer surface of the u layer. The fibre side of the w layer was glued to the mylar sheet of the u layer such that the mylar sheet of the w layer also faces away from the station body. Finally, the v layer was glued onto the assembly. The gluing arrangement was the same as for the u and w layers, i.e. the mylar sheet of the v layer also faces away from the station body.

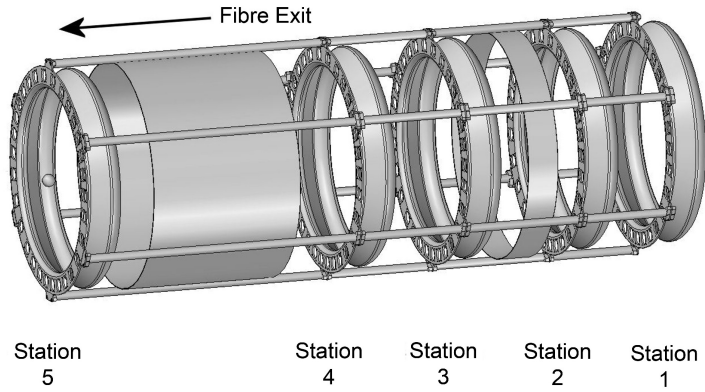

Figure 11.1: Schematic diagram of the MICE tracker. The five stations are shown supported by the carbon-fibre space frame, with fibres omitted for clarity. The station numbering scheme is indicated together with the direction in which the clear-fibre light-guides leave the tracking volume.

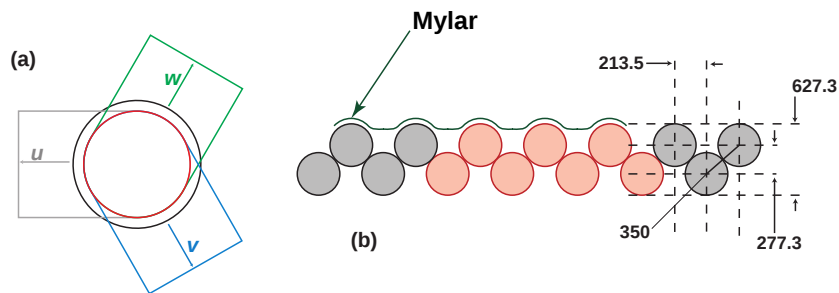

Figure 11.2: (a) Arrangement of the doublet layers in the scintillating-fibre stations. The outer circle shows the solenoid bore while the inner circle shows the limit of the active area of the tracker. The grey, blue, and green regions indicate the direction that the individual $350 \mu\text{m}$ fibres run (moving outward from the centre) in the u , v , and w planes respectively. (b) Detail of the arrangement of the scintillating fibres in a doublet layer. The fibre spacing and the fibre pitch are indicated on the right-hand end of the figure in μm . The pattern of seven fibres ganged for readout in a single clear-fibre light-guide is shown in red. The sheet of Mylar glued to the doublet layer is indicated.

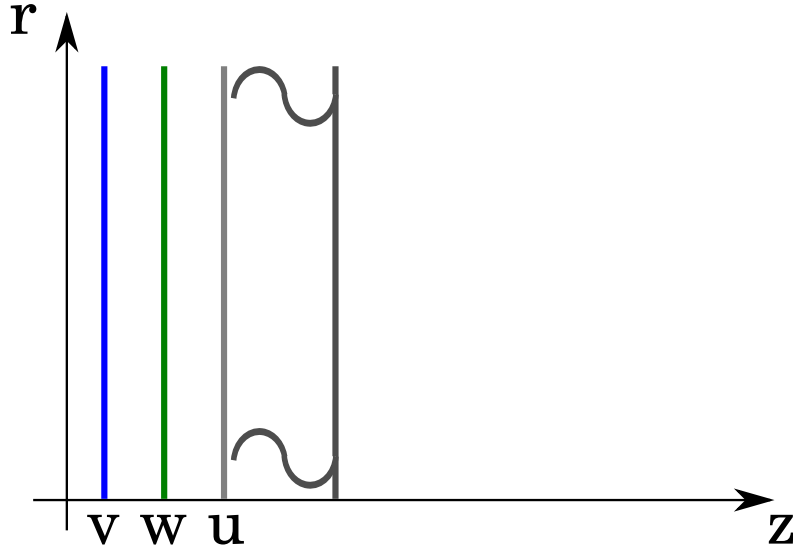

Figure 11.3: The order in which the doublet layers were glued onto the station body. The station body is indicated by the solid black lines. The u layer (shown as the grey line) was glued to the station body first. The w (indicated by the green line) was then glued onto the outer surface of the u layer. The outer doublet layer, the v layer (shown as the blue line) was then glued onto the assembly. The station reference surface and the direction of increasing z are shown as the thin black lines.

11.2.4 Fibre-channel numbering

The numbering of the groups of seven fibres ganged for readout is shown in figure 11.4. With the mylar surface facing up, and with the tails leading out to the station connectors taken to be at the bottom of the figure, the fibre-channel increases from left to right. The coordinate measured by the doublet layer (u , v or w) is taken to increase in the same direction as the channel number. The origin of the measured coordinate is taken to be at the position of the central fibre.

11.3 Reference surfaces and coordinate systems

11.3.1 Doublet layer

The doublet-layer reference surface is defined to be the flat plane that is tangential to the outer surface of the mylar plane as shown in Figure 11.5a. The measured coordinate, $\alpha \in u, v, w$, is defined to lie in this plane and the α axis is perpendicular to the direction in which the fibres run. The doublet-layer z_d axis is defined to be perpendicular to the doublet-layer reference surface increasing in the direction indicated in the figure. The direction in which the measured coordinate, α increases is indicated in figure 11.5b. The orthogonal coordinate in the doublet-layer reference surface that with α and z_d completes a right handed coordinate system is referred to as β . The β axis is also indicated in figure 11.5b.

11.3.2 Station

The station reference surface is defined to coincide with the reference surface of the v doublet layer (see figure 11.6). The station coordinate system is defined such that the y_s axis is coincident with v axis, the z_s axis is coincident with the z_d axis of the v layer and the x_s axis completes a right-handed coordinate system.

11.3.3 Tracker

The tracker reference surface is defined to coincide with the reference surface of station 1. The tracker coordinate system is defined such that the z_t axis coincides with the nominal axis of cylindrical symmetry of the tracker as shown in figure 11.7. The tracker z_t coordinate increases from station 1 to station 5.

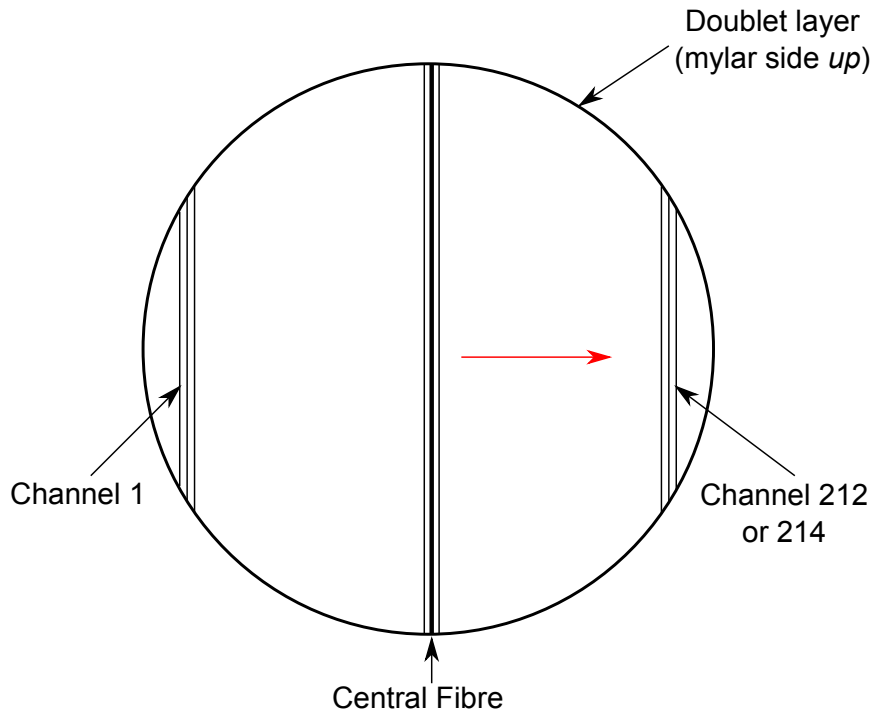

Fibre run to the station optical connectors taken to be towards the bottom of the figure

Figure 11.4: The order in which fibre channels (groups of seven fibres) are numbered. The sensitive surface of the doublet layer is indicated by the solid circle. The direction in which the fibres run is indicated by the vertical lines. The station optical connectors are taken to be at the bottom of the figure as indicated. With the mylar sheet taken to be facing up, fibre-channel number 1 is to the left of the central fibre. The fibre-channel number increases from left to right. The “zero” of the coordinate (u , v or w increases) measured by the doublet layer is taken to be the position of the central fibre. The direction in which the coordinate measured by the double layer increases is indicated by the red arrow.

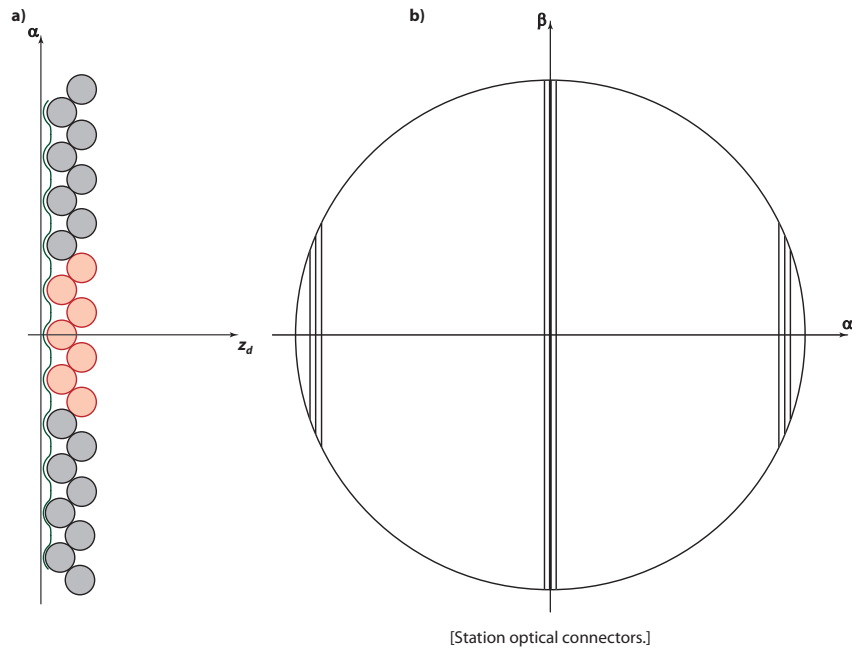

Figure 11.5: Reference surfaces and coordinate-system definitions for the double layer and station. a) The fibres in the doublet layer are shown as the shaded circles, the central channel being shaded pink. The mylar layer is indicated by the solid black corrugated line. The doublet-layer reference surface is indicated by the vertical straight line, the arrow labelled α indicates the direction in which the coordinate measured by the doublet layer (u , v or w) increases. The direction of the z_d axis is indicated. b) View of doublet layer looking down on the mylar layer with the optical connectors at the bottom of the figure. The coordinate measured by the doublet layer (u , v or w) is indicated by the axis labelled α . The orthogonal axis, i.e. the direction in which the fibres run, is labelled β . The origin of the (α, β) coordinate system is taken to be at the centre of the circular active area.

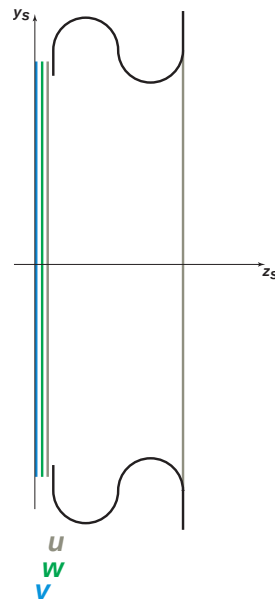

Figure 11.6: The carbon-fibre station body is indicated by the heavy solid black lines. The three doublet layers are indicated by the solid grey (u), green (w) and blue (v) lines. The station reference surface is shown by the solid vertical line coincident with the reference surface of the doublet layer labelled v . The direction y_s axis, defined to be coincident with the v axis and the z_s axes are shown as the solid, black arrows. The x_s axis completes a right-handed coordinate system and therefore points into the page.

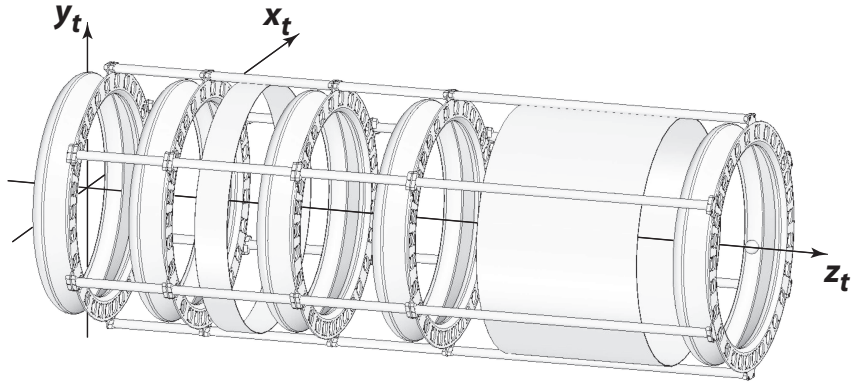

Figure 11.7: The outline of the components that make up the MICE tracker are shown in the line drawing. The tracker reference surface coincides with the reference surface of station 1. The tracker coordinate system is indicated by the solid lines. The y_t axis is defined to be coincident with the y_s axis in the station coordinate system. The z_t axis runs along the nominal axis of the tracker. The x_t axis completes a right-handed coordinate system.

The tracker y_t axis is defined to coincide with the y_s axis of station 1 and the tracker x_t axis completes a right-handed coordinate system.

11.3.4 Coordinate transformations

Doublet-layer to station

The transformation from doublet-layer to station coordinates is achieved using the rotation \underline{R}_{SD} defined by:

$$\mathbf{r}_s = \begin{pmatrix} x_s \\ y_s \end{pmatrix} = \underline{R}_{SD} \mathbf{m} = \begin{pmatrix} \cos \theta_D & -\sin \theta_D \\ \sin \theta_D & \cos \theta_D \end{pmatrix} \begin{pmatrix} \alpha \\ \beta \end{pmatrix}; \quad (11.1)$$

where θ_D is the angle which the fibres that make up the doublet-layer make to the x_s axis in the station coordinate system.

11.4 Reconstruction Algorithms

11.4.1 Hits and clusters

A track passing through a particular doublet layer produces scintillation light in one or at most two fibre channels. For each channel “hit”, the tracker data acquisition system records the channel number, n , and the pulse height. After calibration, the pulse height is recorded in terms of the number of photoelectrons (n_{pe}) generated in the Visible Light Photon Counter (VLPC) illuminated by the hit channel. Occasionally, showers of particles or noise can cause three or more neighbouring channels to be hit. The term “clusters” is used to refer to an isolated hit or a doublet cluster.

The position of a hit in the doublet-layer coordinate system may be determined from the channel number. For isolated hits, the measured coordinate $\alpha \in u, v, w$ is given by:

$$\alpha = c_p(n - n_0); \quad (11.2)$$

where n_0 is the channel number of the central fibre and c_p is the channel pitch given by:

$$c_p = 3.5f_p \quad (11.3)$$

where f_d is the fibre diameter ($f_d = 350 \mu\text{m}$) and f_p is the fibre pitch ($f_p = 427 \mu\text{m}$ see figure 11.2). For clusters in which two channels are hit (“doublet clusters”, see figure 11.8), the measured coordinate

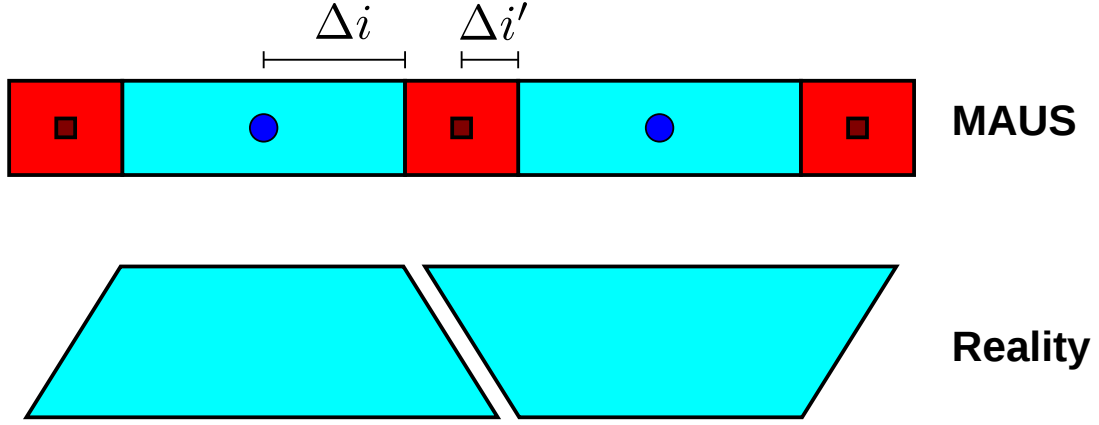

Figure 11.8: Channel overlap as simulated in MAUS; fine-tuning reduces the error associated to doublet clusters.

is given by:

$$\alpha = c_p \left[\frac{(n_1 + n_2)}{2} - n_0 \right]; \quad (11.4)$$

where n_1 and n_2 are the channel numbers of the two hit fibres.

$$\alpha = c_p \left[\frac{\sum_i n_{pei} n_i}{\sum_i n_{pei}} \right]; \quad (11.5)$$

where the subscript i indicates the i^{th} channel. The pulse-height for doublet clusters is determined by summing the pulse height of the hits that make up the cluster.

The “measurement vector”, \mathbf{m} is defined as:

$$\mathbf{m} = \begin{pmatrix} \alpha \\ \beta \end{pmatrix}; \quad (11.6)$$

where α is given above and, in the absence of additional information, $\beta = 0$. The corresponding covariance matrix is given by:

$$\underline{\underline{V_m}} = \begin{pmatrix} \sigma_\alpha^2 & 0 \\ 0 & \sigma_\beta^2 \end{pmatrix}; \quad (11.7)$$

where σ_α^2 and σ_β^2 are the variance of α and β respectively. The variance on α for a single-hit cluster is given by:

$$\sigma_m^2 = \frac{c_p^2}{12}. \quad (11.8)$$

For a doublet-cluster, the variance is given by:

$$\sigma_m^2 = \frac{\Delta_\alpha^2}{12}; \quad (11.9)$$

where $\Delta_\alpha = ?$ is the length of the overlap region between neighbouring fibre channels (see figure 11.8).

The variance of the perpendicular coordinate, β , depends on the effective length, l_{eff} of the fibre (see figure ?? and Appendix ??) and is given by:

$$\sigma_\beta^2 = \frac{l_{\text{eff}}^2}{12}; \quad (11.10)$$

where:

$$l_{\text{eff}} = ?? . \quad (11.11)$$

11.4.2 Space-point reconstruction

This section describes the space-point reconstruction, the algebra by which the cluster positions are translated in to tracker coordinates and, to some extent, the algorithm.

Selection of clusters that form the space-point

For each particle event, the clusters found within each doublet layer are ordered by fibre-channel number. Taking each station in turn, an attempt is made to generate a space point using all possible combinations of clusters. The three clusters, one each from views u , v and w , that make up a space point satisfy:

$$n^u + n^v + n^w = n_0^u + n_0^v + n_0^w; \quad (11.12)$$

where n^u , n^v and n^w are the fibre numbers of the clusters in the u , v and w views respectively and n_0^u , n_0^v and n_0^w are the respective central-fibre numbers (see Appendix 17.1).

A triplet space point is selected if:

$$|(n^u + n^v + n^w) - (n_0^u + n_0^v + n_0^w)| < K. \quad (11.13)$$

Once all triplet space-points have been found, doublet space-points are created from pairs of clusters from different views.

Crossing-position calculation

Doublet space-points The position of the doublet space-point in station coordinates, \mathbf{r}_s , is given by:

$$\mathbf{r}_s = \begin{pmatrix} x_s \\ y_s \end{pmatrix} \quad (11.14)$$

$$= \underline{\underline{R}}_{SD1} \mathbf{m}_1 \quad (11.15)$$

$$= \underline{\underline{R}}_{SD2} \mathbf{m}_2; \quad (11.16)$$

where the measurement vector corresponding to the i^{th} cluster:

$$\mathbf{m}_i = \begin{pmatrix} \alpha_i \\ \beta_i \end{pmatrix}; \quad (11.17)$$

and the rotation matrix $\underline{\underline{R}}_{SDi}$ are defined in section 11.4.1. The simultaneous equations 11.15 and 11.16 contain two unknowns, β_1 and β_2 . Equations 11.15 and 11.16 may be rewritten:

$$\mathbf{m}_1 = \underline{\underline{R}}_{SD1}^{-1} \underline{\underline{R}}_{SD2} \mathbf{m}_2. \quad (11.18)$$

Defining:

$$\underline{\underline{S}} = \underline{\underline{R}}_{SD1}^{-1} \underline{\underline{R}}_{SD2} \quad (11.19)$$

$$= \begin{pmatrix} s_{11} & s_{12} \\ s_{21} & s_{22} \end{pmatrix}; \quad (11.20)$$

Equations 11.15 and 11.16 may be solved to yield:

$$\beta_2 = \frac{\alpha_1 - s_{11}\alpha_2}{s_{12}} \quad (11.21)$$

$$\beta_1 = s_{21}\alpha_2 + s_{22}\beta_2. \quad (11.22)$$

The position of the space-point may now be obtained from equation 11.15 or 11.16.

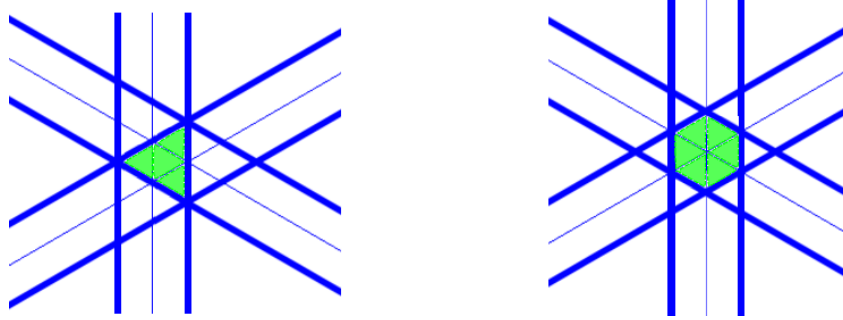

Figure 11.9: Right panel: Fibre arrangement in station 5 of tracker 1. Left panel: Fibre arrangement in the rest of the stations. The shaded region shows the intersection of the three channels is triangle for every station other than station 5, where it will be an hexagon.

Triplet space-points As shown in figure 11.9, the fibres layout is of one of two types. In one case (right panel of figure 11.9), the centre of the channels, one in each of the three views, cross intersect at a single point. In this case, the position of the crossing can be calculated as described in section 11.4.2. When the area of overlap of the three channels forms a triangle (figure 11.9 left panel), the centre of area of overlap is given by:

$$\bar{x} = \frac{2}{3}c_p; \text{ and} \quad (11.23)$$

$$\bar{y} = 0. \quad (11.24)$$

11.4.3 Pattern recognition

Straight-line pattern recognition

In the absence of a magnetic field, the tracks passing through the tracker may be described using a straight line in three dimensions. Taking the z coordinate as the independent parameter, the track parameters may be taken to be:

$$\mathbf{v}^{\text{sl}} = \begin{pmatrix} x_0 \\ y_0 \\ t_x \\ t_y \end{pmatrix}; \quad (11.25)$$

where, x_0 and y_0 are the position at which the track crosses the tracker reference surface, $t_x = \frac{dx}{dz}$ and $t_y = \frac{dy}{dz}$. The track model may then be written:

$$x = x_0 + zt_x; \text{ and} \quad (11.26)$$

$$y = y_0 + zt_y. \quad (11.27)$$

Pattern recognition then proceeds as follows. A space-point is chosen in each of two stations, i and j where i and j label two different stations and $j > i$. Ideally, $i = 1$ and $j = 5$. However, a search of all combinations of pairs for which $j - i > 1$ is made, taking the pairs in the order of decreasing separation in z ; i.e. in order of decreasing $\Delta z_{ji} = z_j - z_i$. Initial values for the track parameters,

$$\mathbf{v}_{\text{Init}}^{\text{sl}} = \begin{pmatrix} x_0^{\text{Init}} \\ y_0^{\text{Init}} \\ t_x^{\text{Init}} \\ t_y^{\text{Init}} \end{pmatrix}, \quad (11.28)$$

are then calculated as follows:

$$t_x^{\text{Init}} = \frac{x_j - x_i}{z_j - z_i}, \quad (11.29)$$

$$x_0^{\text{Init}} = x_i - z_i t_x^{\text{Init}}; \quad (11.30)$$

$$t_y^{\text{Init}} = \frac{y_j - y_i}{z_j - z_i}; \text{ and} \quad (11.31)$$

$$y_0^{\text{Init}} = y_i - z_i t_y^{\text{Init}}; \quad (11.32)$$

where (x_i, y_i, z_i) are the coordinates of space-point i , etc. A search is then made for space-points in each of the stations, k , between station i and station j . The distance between the x and y coordinates of the space-points in the stations k ; $j < k < i$ and the line defined by the initial track parameters is then calculated at the reference surface of station k as follows:

$$\delta x_k = x_k - (x_0^{\text{Init}} + z_k t_x^{\text{Init}}) \text{ and} \quad (11.33)$$

$$\delta y_k = y_k - (y_0^{\text{Init}} + z_k t_y^{\text{Init}}). \quad (11.34)$$

Points are accepted as part of a “trial” track if:

$$|\delta x_k| < \Delta_x \text{ and} \quad (11.35)$$

$$|\delta y_k| < \Delta_y. \quad (11.36)$$

If at least one space-point satisfies this selection, a “trial track” is formed consisting of the space-points selected in stations i, k, \dots and j . For each “trial track”, a straight-line fit is performed to calculate the fit χ^2 :

$$\chi^2 = \chi_x^2 + \chi_y^2. \quad (11.37)$$

If the fit χ^2 satisfies:

$$\frac{\chi^2}{N-2} < \chi_{\text{cut}}^2, \quad (11.38)$$

then the trial track is accepted.

Helix pattern recognition

Helix parameters In the presence of a magnetic field, the tracks passing through the tracker may be described using a helix. In tracker coordinates, the tracks form circles in the (x, y) plane. Defining s to be the length of the arc swept out by the track in the (x, y) plane, a track may be described using a straight line in the (s, z) plane. Taking the z coordinate as the independent parameter, the track parameters may be taken to be:

$$\mathbf{v}^{\text{hlx}} = \begin{pmatrix} x_0 \\ y_0 \\ \psi_0 \\ t_s \\ \rho \end{pmatrix}; \quad (11.39)$$

where, x_0 and y_0 are the position at which the track crosses the tracker reference surface, ψ_0 is the azimuthal angle of the line tangent to the track in the (x, y) plane, $t_s = \frac{ds}{dz}$ and ρ is the radius of curvature. The angle ψ_0 is chosen such that:

$$\hat{\psi}_0 = \hat{\mathbf{k}} \times \hat{\mathbf{r}}; \quad (11.40)$$

where $\hat{\mathbf{r}}$ is the unit vector in the direction (x_0, y_0) and $\hat{\mathbf{k}}$ is the unit vector parallel to the z axis. $\hat{\psi}_0$ is the unit vector tangent to the track and in the direction is defined by ψ_0 . With this definition, the projection on the (x, y) plane of a positive track propagating in the positive z direction sweeps anticlockwise.

Track model for pattern recognition To build up the track model, consider a track-based coordinate system which has its origin at the point (x_0, y_0) and in which the x' axis is parallel to the line joining (x_0, y_0) to the centre of the circle described by the track, the y' axis is parallel to $\hat{\psi}_0$ and the z' axis is parallel to $\hat{\mathbf{k}}$ (see figure 11.10).

A point, i , on the track at (x_i, y_i) (tracker coordinates) at which the track direction is ψ_i may be used to write down the track model as:

$$x'_i = \rho[\cos \phi'_i - 1] \text{ and} \quad (11.41)$$

$$y'_i = \rho \sin \phi'_i; \quad (11.42)$$

where:

$$\tan \frac{\phi'_i}{2} = \frac{\sqrt{(x_i - x_0)^2 + (y_i - y_0)^2}}{2\rho}. \quad (11.43)$$

The z coordinate is taken as a parameter since the construction of the trackers ensures that each reference surface (tracker, station or doublet layer) is at a well defined z . The distance travelled in the (x, y) plane to reach the i^{th} point, s_i , is related to the z coordinate of the i^{th} point by:

$$s_i = t_s z_i; \quad (11.44)$$

since the track is referred to the tracker reference surface. The transformation from the primed to tracker coordinates is achieved with a rotation, $\underline{\underline{R}}'$, through an angle $-\beta$ and a translation, $\underline{\underline{T}}'$ from (x_0, y_0) to $(0, 0)$:

$$\begin{pmatrix} x \\ y \end{pmatrix} = \underline{\underline{T}}' + \underline{\underline{R}}' \begin{pmatrix} x' \\ y' \end{pmatrix}. \quad (11.45)$$

These transformations are given by:

$$\underline{\underline{R}}' = \begin{pmatrix} \cos \beta & -\sin \beta \\ \sin \beta & \cos \beta \end{pmatrix}; \text{ and} \quad (11.46)$$

$$\underline{\underline{T}}' = \begin{pmatrix} -x_0 \\ -y_0 \end{pmatrix}; \quad (11.47)$$

$$(11.48)$$

where:

$$\beta = \psi_0 - \frac{\pi}{2}. \quad (11.49)$$

Collecting space-points in the (x, y) plane Helix pattern recognition follows the same conceptual steps as the straight-line pattern recognition described in section 11.4.3 A space-point is chosen in each of three stations, i , j and k where $k > j > i$. Ideally, $i = 1$, $j = 3$ and $k = 5$. However, a search of all combinations of three space-points for which $k - j > 0$ and $j - i > 0$ is made, taking the combinations in the order of decreasing separation in z ; i.e. in order of decreasing $\Delta z_{kj} = z_k - z_j$ and $\Delta z_{ji} = z_j - z_i$.

A circle in the (x, y) plane may be written (see Appendix 17.3):

$$\alpha(x^2 + y^2) + \beta x + \gamma y + \kappa = 0; \quad (11.50)$$

where:

$$X_0 = \frac{-\beta}{2\alpha}; \quad (11.51)$$

$$Y_0 = \frac{-\gamma}{2\alpha}; \quad (11.52)$$

$$\rho = \sqrt{\frac{\beta^2 + \gamma^2}{4\alpha^2} - \frac{\kappa}{\alpha}}; \quad (11.53)$$

and (X_0, Y_0) are the coordinates of the centre of the circle. Initial values for α , β , γ and κ are obtained as described in Appendix 17.3. The distance between the x and y coordinates of the space-points in the stations l ; $l \neq i, j, k$ and the circle defined by equation 11.50 is given by:

$$\delta = \sqrt{(x_l - X_0)^2 + (y_l - Y_0)^2} - \rho. \quad (11.54)$$

In terms of the parameters α , β , γ and κ , δ may be written:

$$\delta = \sqrt{(x_l^2 + y_l^2) + \frac{\beta^2 + \gamma^2}{4\alpha^2} + \frac{\beta x_l + \gamma y_l}{\alpha}} - \sqrt{\frac{\beta^2 + \gamma^2}{4\alpha^2} - \frac{\kappa}{\alpha}}. \quad (11.55)$$

Points are accepted as part of a “trial” track if:

$$|\delta| < \Delta_C. \quad (11.56)$$

If at least one space-point satisfies this selection, a “trial track” is formed consisting of the space-points selected in stations i, j, k, \dots and l .

For each “trial track”, a circle fit is performed to calculate the fit χ_C^2 . If χ_C^2 satisfies:

$$\frac{\chi^2}{N-3} < \chi_{\text{cut}}^2, \quad (11.57)$$

then the trial track is accepted.

Collecting space-points in the (s, z) plane The set of space points which make up the trial track provide a set of (s, z) coordinates which should lie on a straight line. Equation 11.44 implies:

$$s_i = \rho(\phi'_i - \phi'_0) = t_s z_i. \quad (11.58)$$

The angles turned through as the track propagates from station i to station j ($\Delta\Phi_{ji}$), from station j to station k ($\Delta\Phi_{kj}$) and from station i to station k are then given by:

$$\Delta\Phi_{ji} = \phi'_j - \phi'_i; \quad (11.59)$$

$$\Delta\Phi_{kj} = \phi'_k - \phi'_j; \text{ and} \quad (11.60)$$

$$\Delta\Phi_{ki} = \phi'_k - \phi'_i. \quad (11.61)$$

The definition of the tracker coordinate system ensures that:

$$\frac{\Delta\Phi_{ji} + 2n\pi}{\Delta z_{ji}} = \frac{\Delta\Phi_{kj} + 2m\pi}{\Delta z_{kj}} = \frac{\Delta\Phi_{ki} + 2(n+m)\pi}{\Delta z_{ki}}. \quad (11.62)$$

Defining:

$$\eta_{ji} = \frac{\Delta\Phi_{ji}}{\Delta z_{ji}}; \quad (11.63)$$

$$\eta_{kj} = \frac{\Delta\Phi_{kj}}{\Delta z_{kj}}; \text{ and} \quad (11.64)$$

$$\eta_{ki} = \frac{\Delta\Phi_{ki}}{\Delta z_{ki}}; \quad (11.65)$$

Equations 11.62 may be inverted to yield:

$$m = \frac{\Delta z_{kj}}{2\pi} [\eta_{ji} - \eta_{kj}] + \frac{\Delta z_{kj}}{\Delta z_{ji}} n. \quad (11.66)$$

The correct values for n and m may now be obtained by calculating:

$$\Lambda = \eta_{ji} - \eta_{kj}; \text{ and} \quad (11.67)$$

$$\Gamma = \frac{2\pi}{\Delta z_{ji}} \left[m - \frac{\Delta z_{ki}}{\Delta z_{ji}} n \right]. \quad (11.68)$$

The most likely values of n and m for the cases of interest are $n = 0$ and $m = 0$. Therefore, searching for values of n and m for which:

$$|\Lambda - \Gamma| < \Delta_{sz}; \quad (11.69)$$

will yield the change in ϕ' that corresponds to a step in z .

The final step in gathering the points in (s, z) is to perform a straight line fit to the set of points corrected for multiple turns between stations. If the track fit χ_{sz}^2 satisfies:

$$\chi_{sz}^2 < \chi_{szC}^2; \quad (11.70)$$

then an attempt is made to fit a helix to the set of space points that make up the track.

Helix fit At present, pattern recognition does not employ a full 3D helix fit, due to the complexity of performing a non-linear least squares fit. The following is for reference only.

The construction of the tracker allows the helical locus of the points on the track to be parameterised as a function of z . The step from station i to station j , a change in the z position of the track of $\Delta z_{ji} = z_j - z_i$, results in a change in ϕ' , and therefore s , where:

$$\Delta\Phi_{ji} = \frac{t_s \Delta z_{ji}}{\rho}; \text{ and} \quad (11.71)$$

$$\Delta s_{ji} = \rho \Delta\Phi_{ji} = \rho(\psi_j - \psi_i). \quad (11.72)$$

The coordinates of the track at the i^{th} station may now be written:

$$\mathbf{v}_i^{\text{hlx}} = \mathbf{v}^{\text{hlx}} + \Delta\mathbf{v}_i^{\text{hlx}}; \quad (11.73)$$

where:

$$\Delta\mathbf{v}_i^{\text{hlx}} = \begin{pmatrix} \Delta x_{i0} \\ \Delta y_{i0} \\ \Delta\Psi_{i0} \\ 0 \\ 0 \end{pmatrix}. \quad (11.74)$$

$\Delta\Psi_{i0} = \psi_i - \psi_0$ and Δx_{i0} and Δy_{i0} are obtained by evaluating:

$$\Delta x_{i0} = x_i - x_0; \text{ and} \quad (11.75)$$

$$\Delta y_{i0} = y_i - y_0 \quad (11.76)$$

where:

$$\mathbf{h}_i^{\text{hlx}} = \begin{pmatrix} x_i \\ y_i \end{pmatrix} = \underline{\underline{T}}' + \underline{\underline{R}}' \begin{pmatrix} x'_i \\ y'_i \end{pmatrix}; \quad (11.77)$$

and:

$$\phi'_i = \phi_0 + \Delta\Psi_{i0}. \quad (11.78)$$

The helix fit described in Appendix 17.4 proceeds by minimizing:

$$\chi_{\text{hlx}}^2 = \sum_i^N \left\{ [\mathbf{m}_i^{\text{sp}} - \mathbf{h}_i^{\text{hlx}}]^T [\underline{\underline{V}}_{ii}^{\text{sp}}]^{-1} [\mathbf{m}_i^{\text{sp}} - \mathbf{h}_i^{\text{hlx}}] \right\}. \quad (11.79)$$

If the helix fit χ_{hlx}^2 satisfies:

$$\frac{\chi_{\text{hlx}}^2}{2N - 5} < \chi_{\text{hlxC}}^2; \quad (11.80)$$

then the trial track is accepted.

11.4.4 Track fit

11.5 Data structure

The tracker data structure, a subset of the general MAUS data structure, is shown in figure 11.11. The basic unit of the MAUS data structure is the spill, representing the data produced by a single actuation of the MICE target. All MAUS modules (mappers, reducers, etc.) act on one spill at a time. The spill is then split into two sides, Monte Carlo data and reconstructed data. A key rule is that MC data must never be stored on the reconstruction side. Each side has its own event class, representing data corresponding to a single MICE particle trigger event. The relationship between the spill and the MC and recon event objects is one-to-many.

Within an MC event the only data object pertaining to the tracker is the SciFiHit, implemented as template class of the generic Hit class. This class stores the MC data used by the reconstruction to form SciFiDigits (via the map MapCppTrackerMCDigitisation). The relationship between MC events and SciFiHits is one-to-many.

On the real data side each recon event holds a single SciFiEvent (a one-to-one relationship). The SciFiEvent then holds a collection (implemented as C++ standard vectors of pointers) for each data type used in the reconstruction process: SciFiDigits, SciFiClusters, SciFiSpacePoints, SciFiStraightPRTracks, SciFiHelicalPRTracks, SciFiStraightKalmanTracks, and SciFiTracks. Additionally SciFiTrackPoints are held by each SciFiTrack instance.

11.6 Code Design

11.6.1 General Code Structure

The main body of the tracker code is implemented as three distinct MAUS map modules and, at present, one reducer module. There also exist various helpful top-level user tools, and the tracker geometry, calibration and configuration files. A diagram showing the tracker software data flow with the corresponding modules is shown in figure 11.12, with the following sections expanding on each area.

MapCppTrackerDigits

This map is used to digitise real data. It calls on additional functionality from the RealDataDigitisation class, which is stored in `src/common_cpp/Recon/SciFi`.

MapCppTrackerMCDigitisation

This map is used to digitise Monte Carlo data.

MapCppTrackerRecon

This map performs the main reconstruction work, moving from digits to cluster to spacepoints to pattern recognition tracks, and finally full Kalman tracks. Most work is farmed out to backend C++ classes. The following are the top level classes for each stage of the reconstruction, and are stored in `src/common_cpp/Recon/SciFi`:

- SciFiClusterRecon - cluster reconstruction from digits
- SciFiSpacepointRecon - spacepoint reconstruction from cluster
- PatternRecognition - association of spacepoints to tracks, and crude initial track fit

The backend classes for the final track fit are stored under `src/common_cpp/Recon/Kalman` and `src/common_cpp/Recon/Bayes`, the top level class being KalmanTrackFit. Other classes used include:

- KalmanFilter
- KalmanHelicalPropagator
- KalmanStraightPropagator
- KalmanState
- KalmanSeed

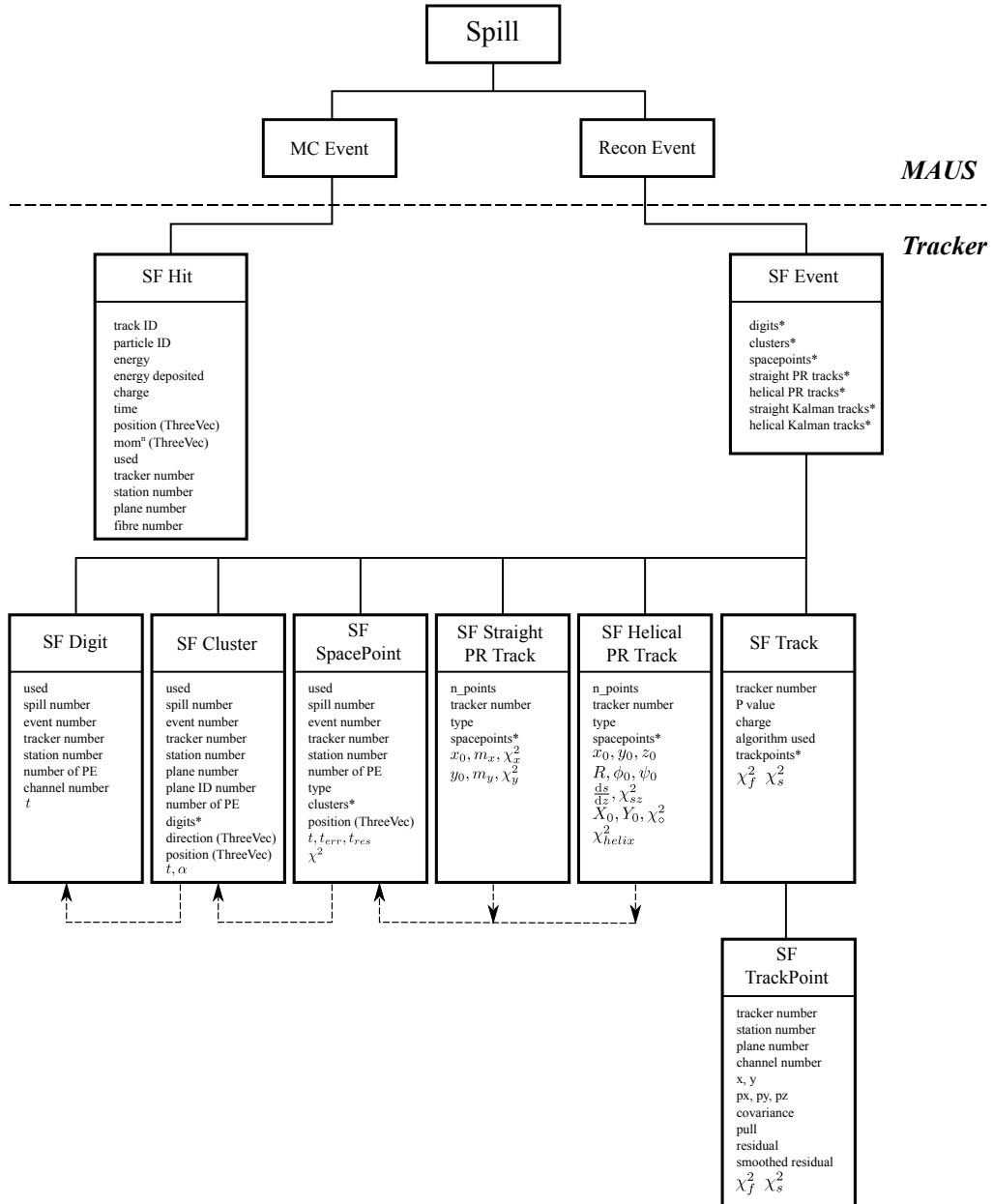

Figure 11.11: The tracker data structure and its position within the general MAUS data structure. An asterisk indicates a vector of pointers. The dotted lines indicate cross links realised as vectors of pointers.

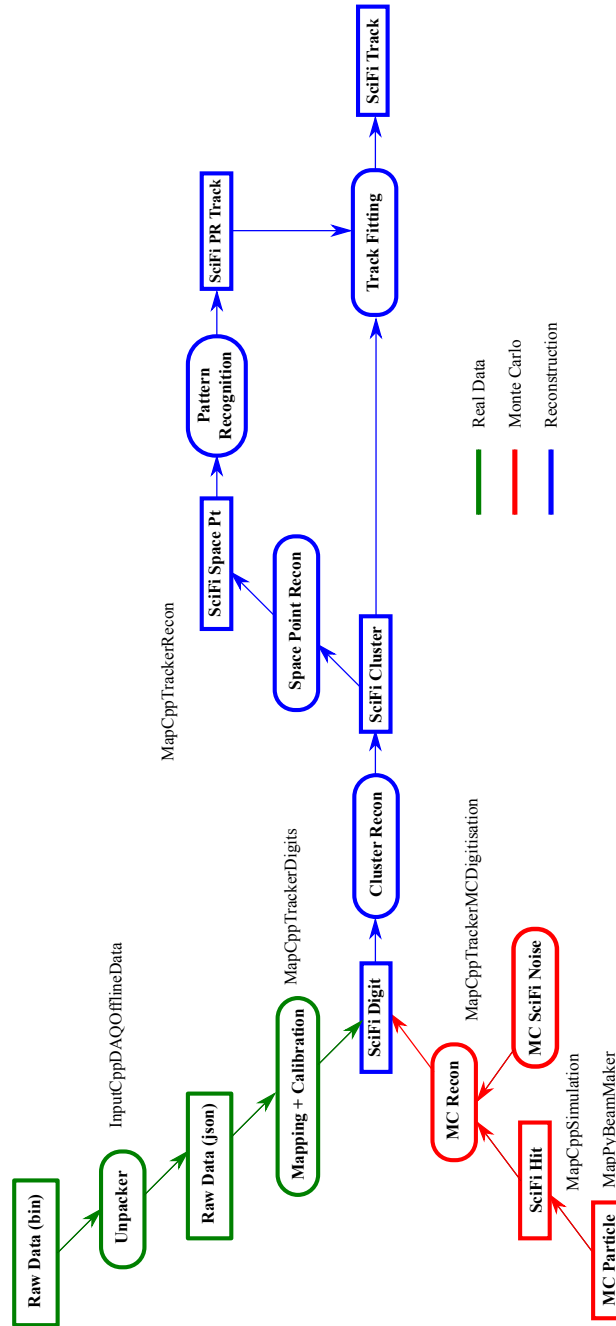

Figure 11.12: Schematic of the tracker software data showing MC and Real data input, and subsequent reconstruction. MAUS modules corresponding to given process are indicated (MapCppTrackerRecon encompasses all of the reconstruction, shown in blue). Once digits have been formed, reconstruction is agnostic as to whether the MC or Real path was followed.

ReduceCppPatternRecognition

This reducer displays spacepoints and pattern recognition tracks by tracker, in the $x-y$, $x-z$ and $y-z$ projections, an example being shown in figure 11.13. It also creates an InfoBox, which displays various information for the spill and run, such as the number of clusters, spacepoints, etc. The plots are made using ROOT TGraphs, and the InfoBox with a TPaveText.

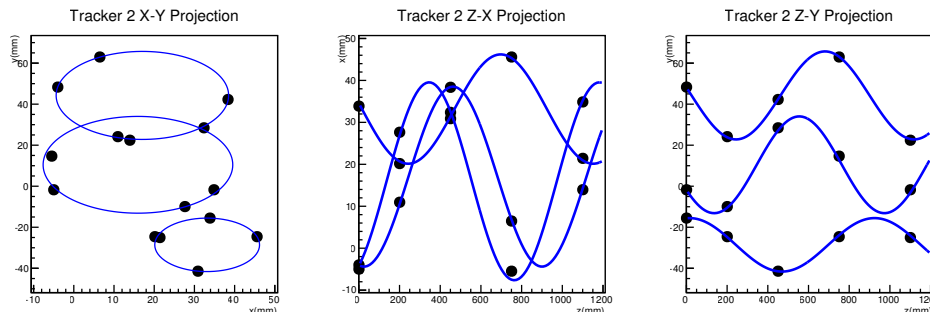

Figure 11.13: Output from the pattern recognition reducer showing the real space projections of a three event spill in tracker 2.

Reducer Backend

The backend classes for the reducers are held in `src/common_cpp/Plotting/SciFi`. They consist of a reduced tracker data container class, `TrackerData`, a series of plotting class based on ROOT, and a manager class `TrackerDataManager`, used to populate the `TrackerData` and call the various plotters. The plotters themselves inherit from a base class, `TrackerDataPlotterBase`. Each daughter class overloads the bracket operator, taking in arguments of two `TrackerData` objects, one per tracker, and a ROOT `TCanvas`, to plot on. The current types available are:

- **Info Box**: displays various information on the spill and run in text
- **Spacepoints**: displays spacepoint positions in $x-y$, $x-z$, and $y-z$
- **Tracks**: displays pattern recognition tracks in $x-y$, $x-z$, and $y-z$
- **XYZ**: calls `Tracks` and `Spacepoints` to display them both together
- **SZ**: displays pattern recognition tracks in $s-z$ (s being the distance swept out by a particle in the $x-y$ plane)

11.6.2 Tracker configuration variables

Variable	Default	Description
SciFiMUXNum	7	
SciFiFiberDecayConst	2.7	
SciFiFiberConvFactor	3047.1	
SciFiFiberTrappingEff	0.056	
SciFiFiberMirrorEff	0.6	
SciFiFiberTransmissionEff	0.8	
SciFiMUXTransmissionEff	1.0	
SciFivlpcQE	0.8	
SciFivlpcEnergyRes	4.0	VLPC energy resolution (MeV)
SciFivlpcTimeRes	0.2	VLPC time resolution (ns)
SciFiadcFactor	6.0	
SciFitdcBits	16	
SciFitdcFactor	1.0	
SciFinPlanes	3	
SciFinStations	5	
SciFinTrackers	2	
SciFiNPECut	2.0	
SciFiClustExcept	100	
SciFi_sigma_tracker0_station5	0.4298	Tracker 1 station 5 resolution (mm)
SciFi_sigma_triplet	0.3844	Spacepoint triplet resolution (mm)
SciFi_sigma_z	0.081	(mm)
SciFi_sigma_duplet	0.6197	(mm)
SciFiPRHelicalOn	True	Helical pattern recognition flag
SciFiPRStraightOn	True	Straight pattern recognition flag
SciFiRadiusResCut	150.0	Helix radius cut (mm)
SciFiNTurnsCut	0.75	Cut checking turns between stations is correct
SciFiMaxPt	180.0	Transverse momn. upper limit cut used in pat rec
SciFiMinPz	180.0	Longitudinal momn. lower limit cut used in pat rec
SciFiPerChanFlag	0	
SciFiNoiseFlag	1.5	
SciFiCrossTalkSigma	50.0	
SciFiCrossTalkAmplitude	1.5	
SciFiDarkCountProababilty	0.017	Probability of dark count due to thermal electrons
SciFiChannelCalibList		Channel calibration data location
SciFiParams_Z	5.61291	
SciFiParams_Plane_Width	0.6523	
SciFiParams_Radiation_Legth	424.0	
SciFiParams_Density	1.06	
SciFiParams_Mean_Excitation_Energy	68.7	
SciFiParams_A	104.15	
SciFiParams_Pitch	1.4945	
SciFiParams_Station_Radius	160.	
SciFiParams_RMS	370.	
SciFiSeedCovariance	1000	Error estimate for seed values of the Kalman fit
SciFiKalman_use_MCS	True	Flag to add multiple scattering to the Kalman fit
SciFiKalman_use_Eloss	True	Flag to add energy loss to the Kalman fit
SciFiUpdateMisalignments	False	Do a misalignment search and update
SciFiKalmanVerbose	False	Dump information per fitted track

11.7 The Monte Carlo

The tracker Monte Carlo can be run using the script at the beginning of the tracker section. In addition to the basic Monte Carlo noise from dark count in the VLPCs can be simulated by including the mapper `MapCppTrackerMCNoise`, which should be run before `MapCppTrackerMCDigitization`. Reconstruction after digitization is agnostic to source by design decision.

11.7.1 Station Geometry

The tracker geometry is built in Geant4 on a fibre-by-fibre basis. The size of the active tracker plane and the fibre diameter is defined in the mice modules. The fibre offset and translation are determined in code, the length of the fibres are then determined by its position within the plane. Fibre placement is then iterated over from one end of the plane to the other filling in all gaps within the area.

Each of the three scintillating fibre planes is built up this way. In addition to these the Monte Carlo also includes a thin layer of mylar sandwiched between these planes. The relative position of the three tracking planes and the three mylar layers within the station are defined in the mice modules.

11.7.2 MC VLPC Dark Count

When the mapper `MapCppTrackerMCNoise` is included in the MC each channel is tested for the presence of an integer number of PE randomly appearing in the data. The chance of this per channel noise is defined by the parameter `SciFiDarkCountProbabilty` within the data cards, while the number of PE generated is given by a Poisson distribution. If a noise hit is produced it is recorded to be passed to digitization later.

11.7.3 Building Digits

When a particle crosses a scintillating fibre in the MC it may deposit some amount of energy in passing determined by Geant4. The digitization process takes this deposited energy and transforms it into a number of PE as follows:

$$NPE = Energy \times SciFiFiberConvFactor \times SciFiFiberTrappingEff \times \\ (1.0 + SciFiFiberMirrorEff) \times SciFiFiberTransmissionEff \times \\ SciFiMUXTransmissionEff * SciFivlpcQE; \quad (11.81)$$

Where the value of each of these variable other than the deposited energy is given in the data cards.

Hits in the same tracker, station, and plane are collected together to form a single digit. The grouping of digits are merged with any noise effects and a Gaussian smearing is applied to the total NPE to finish the digitization process.

Chapter 12

Global Track Matching

12.1 Purpose

The purpose of Track Matching is to assembly hits and tracks in the various detectors into global tracks, (upstream, downstream, and through-going) by determining which hits belong together and creating new tracks containing them. PID (see next section) can then be performed on the resulting tracks.

12.2 Process

Track Matching is performed in several steps. First, tracks for the upstream and downstream sections of the beamline are assembled by matching hits and tracks from the various other detectors to tracks produced by the trackers (if no tracker track exists, no matching is performed). Then, upstream and downstream tracks from the event are matched together.

As particle masses and charges are required for propagation (see section 12.2.1), multiple tracks are created for the various PID hypotheses. If the tracker can produce a charge hypothesis due to the direction of the helical track, three tracks are created (in case of pion, muon, or electron of the corresponding charge), otherwise six.

Note that in the default setting, the upstream and downstream tracks are only created by explicit matching if one of the detectors has more than one hit (or track), otherwise all it is simply assumed that the hits come from the same particle and tracks are assembled accordingly.

12.2.1 4th Order Runge-Kutta Propagation

Matching to the various detectors (see below) is generally done using a 4th order Runge-Kutta propagation routine (implemented as a wrapper for the GSL RK4 Integration). A trackpoint from the outermost tracker station (most upstream for the upstream beamline, most downstream for the downstream beamline) provides the input which is then propagated backwards / forwards to the other detectors. A maximum allowed disagreement between x and y position of propagated vs. reconstructed hits (detector resolution plus an additional allowance for multiple scattering) is typically used as matching criterion (see below).

Energy loss is included in the propagation and implemented as follows:

After every step, the midpoint between previous and current position is calculated and the material at that point obtained from the geometry. This, together with PID, energy, and distance between previous and current positions is used to calculate energy loss (or energy gain for backwards-propagation) via the Bethe-Bloch formula. Furthermore, at every step, the distance to the nearest material boundary is determined, and if lower than the step size, the step size is reduced significantly, both to minimize inaccuracies arising from an underestimated straight-line step distance in materials with high stopping power (Material layers in the beamline are all relatively thin, so in such materials the nearest boundary will always be close) and to ensure that the material during a step is uniform.

12.2.2 TOF1, TOF2, KL

For TOF1, TOF2, and the KL, the matching tolerance is a fixed value that can be configured for each detector in the datacards (see section 12.4).

12.2.3 TOF0

The beamline optics between TOF1 and TOF0 make propagation-based matching to TOF0 unfeasible (typical position and momentum errors in the tracker are vastly magnified once propagation has reached TOF0), so a slightly different method is used: First, propagation is performed to the upstream end of TOF1. Then, based on the momentum components at this point, the travel distance from TOF0 is estimated and used to calculate an approximate energy loss over that distance. By applying half of this as an energy-gain to the particle on the upstream edge of TOF1, we obtain an approximate (as we do not account for fringe-field effects from Q7-9) average energy for the travel between the TOFs. From this, we can obtain an expected Δt between TOF0 and TOF1, which is then compared to the reconstructed Δt . The maximum allowed discrepancy between the two can be configured in the datacards.

Note that TOF0 matching can only be performed if TOF1 matching was successful.

12.2.4 Cherenkov Detectors

As the Cherenkov detectors don't have the time resolution to resolve multiple particles within a trigger window, Cherenkov hits are added to the track without any checks.

12.2.5 EMR

Matching to the EMR (specifically to the most upstream trackpoint of an EMR track) works similar to matching to TOF1, TOF2, and KL, but rather than using a fixed distance as a matching tolerance, the tolerance is scaled by the position error reported by the EMR. A scaling coefficient can be configured in the datacards.

12.2.6 Upstream-Downstream Matching

For Upstream-Downstream matching, a cut is imposed on the maximum and minimum average β_z (where $\beta = \frac{v}{c}$, not the beta function) between TOF1 and TOF2. The maximum and minimum can be configured in the datacards.

12.3 Usage

To use Track Matching in a MAUS module chain, simply include the mappers `MapCppGlobalReconImport` (which imports all locally reconstructed data into a global event) and `MapCppGlobalTrackMatching` in your mapper chain just after all local reconstruction mappers (or as the first mappers if you are working with data that is already unpacked).

12.4 Configuration

track_matching_pid_hypothesis If the PID hypotheses used for track matching should be limited to a single PID, change to either one (never several) of "kEPlus", "kEMinus", "kMuPlus", "kMuMinus", "kPiPlus", "kPiMinus". Otherwise, leave at "all".

track_matching_tolerances Global Track Matching tolerances for the various subdetectors

TOF0t Tolerance in ns for matching to TOF0.

TOF1x, TOF1y, TOF2x, TOF2y, KLy Tolerance in mm. For the KL, only the y coordinate is used, as the KL does not resolve the x-position.

EMRx, EMRy Multiplier for the standard tolerance for the EMR which is the reconstructed error $\times \sqrt{12}$

TOF12maxSpeed, TOF12minSpeed Maximum and minimum average speed of the particle between TOF1 and TOF2 as a fraction of c in order to match an upstream and a downstream track.

track_matching_energy_loss Whether to use energy calculations for Global Track Matching. If for a given run there are no fields between TOF1 and EMR, this can be set to `False` for a slight speed-up, though the TOF0 tolerance would have to be increased. Safer to leave on.

track_matching_no_single_event_check Whether propagation matching (for individual detectors, this does not affect the Upstream-Downstream Matching (see section 12.2.6)) should not be performed if each detector has no more than one hit (significantly increases execution speed).

track_matching_charge_thresholds If `track_matching_no_single_event` is activated, this will cause propagation matching to still occur if one of the hits has a charge deposit below the threshold (i.e. is likely noise). **NOT CURRENTLY IMPLEMENTED**

track_matching_through_matching Whether upstream and downstream tracks should be assembled into through tracks (contingent upon meeting a time-of-flight cut, see above).

global_merge_kl_cell_hits Whether if multiple adjacent hits in the KL exist, these should be merged upon import into the global datastructure.

Chapter 13

Global PID

13.1 Introduction

The global PID framework is designed to use sets of PID variables to 1) use MC data to create PDFs of these variables for a range of particle hypotheses, and 2) to use the PDFs as part of a log-likelihood method to determine the PID of reconstructed global tracks from data. The framework is designed such that new PID variables can be added as they are developed. Section 1 of this document will explain how to use the PID to produce PDFs, and how to perform PID on spill data contained within a Json document. Section 2 will detail how these two actions are performed within the code, and in Section 3 the PID variables, their structure, how new ones can be added to the framework, and details of those already in place, will be discussed. This document will be updated as the PID framework and variables continue to be developed.

13.1.1 Using the PID scripts

13.1.2 Producing PDFs

Whilst the PID framework will eventually come with PDFs provided (for the standard MICE beam settings) in `PIDhists.root`, it is possible for a user to produce PDFs for hypotheses not included within this file. Due to current MC availability, users currently need to produce their own PDFs. The following describes how this should be done.

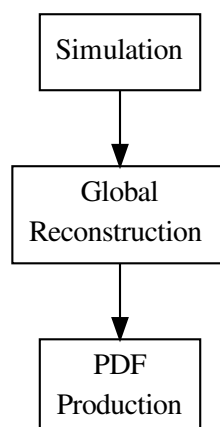

Figure 13.1: Steps involved in producing a PDF from MC data

- Simulation: Production of MC data for a given beam setting. Ideally G4Beamline input would be used, however input from spill generation in MAUS can be used but in the simulation datacards `n_particles_per_spill` should be set to 1, as global track matching cannot process multiple particles per spill until there exists an MC trigger.
- Global Track Reconstruction: The MC data should then be passed through the global track reconstruction, performed by `MapCppGlobalReconImport` and `MapCppGlobalTrackMatching`, which import the detector information into the global event and then construct the global tracks required for the calculation of PID variables. During the `TrackMatching` stage, it will have been possible for the user to choose to produce tracks for a single pid hypothesis or for several- for the purposes of PDF production a single hypothesis should be chosen, otherwise tracks will be duplicated. The choice of hypothesis doesn't matter as long as the `track_matching_tolerances` are set to large values (i.e. 10 x larger than those in `ConfigurationDefaults.py`). This is permissible as long as there is a single particle per spill in the simulation, as mentioned previously, because there will not be extra particles to be mis-matched to, and before the PDFs are populated the MC pid of the track is checked.
- PDF Production: To produce the PDFs from the reconstructed MC data, `pid_pdf_production.py` in `MAUS_ROOT_DIR/bin/Global` is then used. This script calls the reducer `ReduceCppGlobalPID`. With this script, a datacard, such as that shown given in listing 13.1, that includes the datacards required to be set by the reducer, is used by entering at the command line:

```
> MAUS_ROOT_DIR/bin/Global/pid_pdf_generator.py \
    --configuration_file pdf_example_datacard.py
```

This will create a directory within `MAUS_ROOT_DIR/files/PID` corresponding to the beam setting and identifier given by the datacard, which will then contain files for each PID variable, each of which will contain the PDF for each possible particle type. These can be combined into a single root file using the `hadd` command (see man pages for command usage).

```
import os
import datetime

# Use the current time and date as a unique
# identifier when creating files to contain PDFs.
# A unique_identifier is required by the reducer,
# and PDF production will fail without one.
now = datetime.datetime.now()
unique_identifier =
    now.strftime("%Y_%m_%dT%H_%M_%S_%f")

# A root file containing global tracks from MC
# data
input_json_file_name =
    "global_track_input.root"

# PID MICE configuration, 'step_4' for Step IV running,
# 'commissioning' for field free commissioning data
# (straight tracks). Default is step_4
pid_config = "step_4"

# Tag used by both MapCppGlobalPID and
# ReduceCppGlobalPID, determines which PDFs to
# perform PID against/which PDFs to produce (in this
# case, set based upon input MC beam). A typical tag
# here would be the emittance and momentum, e.g.
# 3-140, 6-200, etc. Alternatively, users may choose to
# enter the run number they are simulating for here.
```

```

# The tag used for the PDFs must match the tag you
# use when doing PID
pid_beam_setting = "6-200"

# Polarity of running mode, value can be "positive"
# or "negative".
pid_beamline_polarity = "positive"

```

Listing 13.1: An example datacard (pdf_example_datacard.py) for use with pid_pdf_generator.py

Performing PID with pre-existing hypotheses

To perform PID on data, the steps shown figure 13.2 should be followed.

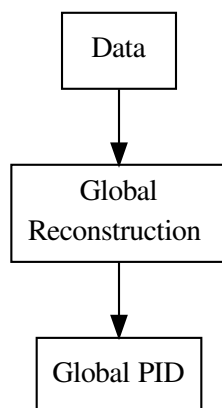

Figure 13.2: Steps involved in performing the PID for a data sample

- Data: This can be experimental or MC data.
- Global Reconstruction: In the same way as described above for PDF generation, the data should then be passed through the global reconstruction.
- Global PID: To perform the PID on the reconstructed data, GlobalPID.py in `MAUS_ROOT_DIR/bin/Global` is then used. This script calls the MapCppGlobalPID mapper. With this script, a datacard, such as that shown given in listing 13.2, that includes the input and output root filenames, is used, by entering the following at the command line:

```

> MAUS_ROOT_DIR/bin/Global/GlobalPID.py \
  --configuration_file example_pid_datacard.py

```

```

import os

# A root document containing global tracks
input_root_file_name =
    "global_recon_output.root"

# Output root file with track pid info included

```

```

output_root_file_name =
    "output_Global_PID.root"

# Path to PDFs file. Users should enter the path
# to their own PDFs file here
PID_PDFs_file = " "

# PID MICE configuration, 'step_4' for StepIV running,
# 'commissioning' for field free commissioning data
# (straight tracks). Default is step_4
pid_config = "step_4"

# PID running mode - selects which PID variables are
# used. 'online' corresponds to less beam (momentum)
# dependent variables, 'offline' uses all variables
# and requires that specific PDFs already exist for
# the beam.
pid_mode = "offline"

# Tag used by both MapCppGlobalPID and
# ReduceCppGlobalPID, determines which PDFs to
# perform PID against/which PDFs to produce (in this
# case, set based upon input MC beam). A typical tag
# here would be the emittance and momentum, e.g.
# 3-140, 6-200, etc. Alternatively, users may choose
# to enter the run number they are simulating for
# here. The tag used for the PDFs must match the tag
# you use when doing PID
pid_beam_setting = "6-200"

# Polarity of running mode, value can be "positive"
# or "negative".
pid_beamline_polarity = "positive"

# PID confidence level = set the margin (in percent)
# between the confidence levels of competing pid
# hypotheses before they are selected as the correct
# hypothesis
pid_confidence_level = 10

# PID track selection- select which tracks from
# TrackMatching to perform PID on. Can perform PID on
# all tracks by setting to "all", on through tracks
# only (constituent tracks will be PID'd, so this
# excludes orphans) with "through" or on all upstream
# and downstream tracks (ignoring whether tracks have
# been through-matched) with "constituents"
pid_track_selection = "all"

```

Listing 13.2: An example datacard (example_pid_datacard.py) for use with GlobalPID.py

As the framework currently stands, the output file would now contain the global tracks with the PID set (where it has been possible to do so) to whichever particle hypothesis had the highest confidence (if it passes the confidence level cut), and the mapper name of the track will have been set to MapCppGlobalPID-<pid_track_selection>, e.g. if the datacard setting was pid_track_selection = "Through", the mapper name would be MapCppGlobalPID-Through.

13.2 MapCppGlobalPID and ReduceCppGlobalPID

13.2.1 MapCppGlobalPID

The steps taken in MapCppGlobalPID for a single track are shown in figure 13.3. To express this more fully, the data, having passed through the global reconstruction, is then passed to the PID. For each track, the values of each PID variable are calculated. Each of these values is then compared to the corresponding PDFs for all particle hypotheses, the number of entries in the corresponding bin providing the probability from which the log-likelihood is calculated. For each particle hypothesis, the log-likelihoods of all of the PID variables are summed to give a log-likelihood for that hypothesis. The PID of the track is then obtained by comparing the log-likelihoods of the hypotheses.

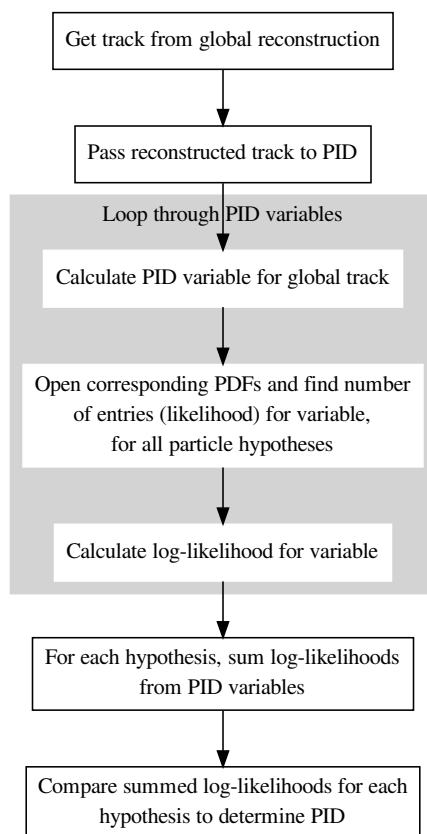

Figure 13.3: Flow chart detailing steps taken in MapCppGlobalPID

13.3 ReduceCppGlobalPID

The steps taken in ReduceCppGlobalPID are shown in figure 13.4. MC data for a given particle hypothesis, having passed through the global reconstruction, is then passed to the PID. For each track, the values of each PID variable are calculated. A histogram is filled with these values. If the behaviour has been turned on in the PID variable class, then a single event is spread over all bins in the histogram, to ensure that when the PDF is used by the PID, there will be no empty bins, thus avoiding cases where the log-likelihood takes the log of zero. The histogram is then normalised to create the PDF, which is then written and saved to file. If a MC track returns a variable value outside of the allowed range of the histogram (as defined within the variable class) then the value for that track is not included.

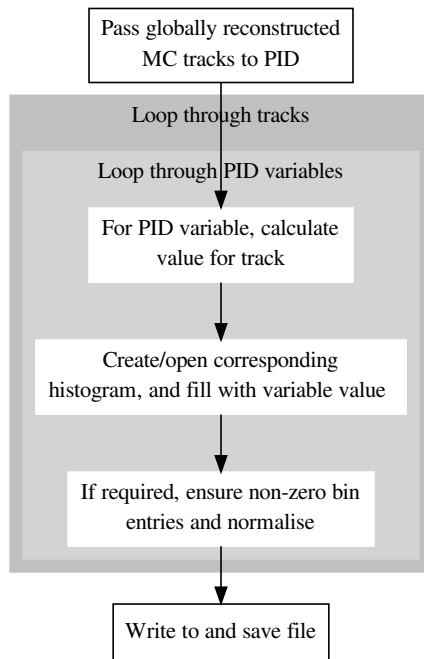

Figure 13.4: Flow chart detailing steps taken in ReduceCppGloPID

13.4 PID Variables

Information from the MICE detectors are incorporated into a set of PID variables that can be used to distinguish between particle hypotheses. The Global PID framework has been written such that any number of PID variables can be developed and added as necessary, all represented by their own class, derived from a base class.

13.4.1 PID Base Class

The base PID class (PIDBase.hh and .cc) contains the functions to:

- Create the PDFs (and the files that contain them)
- Use the PDFs with globally reconstructed tracks
- Populate the PDFs with variable values (after checking that value is valid)
- Perform the log-likelihood for an incoming globally reconstructed track (after checking that value of variable for track falls within range of PDF).
- Calculate the value of the PID variable (this is a virtual function to be defined in the derived classes)

There are separate base classes for single value variables (PIDBase1D) and dual value variables (PIDBase2D).

13.4.2 PID Variable Classes

Each PID variable will be implemented in a derived class of the appropriate base PID class. Because of how the framework is designed, new variables can be added as they are developed. There are currently two sets of variables, those to be used when there is no field in the spectrometer solenoids (commissioning variables, CompIDVars) and those to be used during Step IV running (PIDVars).

ComPIDVars

PID class	Variable name	Definition
ComPIDVarA	diffTOF2TOF1	Uses the time of flight between TOF1 and TOF2. Beam dependent.
ComPIDVarB	KLChargeProdvsDiffTOF1TOF2	Uses the KL ADC charge product, and the time of flight between TOF1 and TOF2.
ComPIDVarC	CommissioningKLADCChargeProduct	Uses the KL ADC charge product . Beam dependent.
ComPIDVarD	CommissioningEMRrange	Uses the range of the particle as measured in the EMR. Beam dependent.
ComPIDVarE	CommissioningEMRrangevsDiffTOF1TOF2	Uses the range of the particle as measured in the EMR, and the time of flight between TOF1 and TOF2.
ComPIDVarF	CommissioningEMRPlaneDensity	Uses the plane hit density in the EMR. Beam dependent.
ComPIDVarG	CommissioningEMRPlaneDensityvsDiffTOF1TOF2	Uses the plane hit density in the EMR, and the time of flight between TOF1 and TOF2.
ComPIDVarH	CkovAvsDiffTOF1TOF2	Uses the number of photoelectrons in Cherenkov A, and the time of flight between TOF1 and TOF2.
ComPIDVarI	CkovBvsDiffTOF1TOF2	Uses the number of photoelectrons in Cherenkov B, and the time of flight between TOF1 and TOF2.

PIDVars

PID class	Variable name	Definition
PIDVarA	diffTOF1TOF0	Uses the upstream time of flight, between TOF0 and TOF1. This variable is beam dependent and so is best used during offline data analysis where PDFs can be produced for specific beam settings.
PIDVarB	diffTOF0TOF1vsTrackerMom	Uses upstream time of flight, and momentum as measured in the upstream Tracker.
PIDVarC	KLChargeProdvsDSTrackerMom	Uses the KL ADC charge product and the momentum measured in the downstream Tracker.
PIDVarD	KLADCChargeProduct	Uses the KL ADC charge product. This variable is beam dependent, and so is best used during offline data analysis.
PIDVarE	EMRRange	Uses the range of the particle as measured in the EMR. This variable is beam dependent, and so is best used during offline data analysis.
PIDVarF	EMRRangevsDSTrackerMom	Uses the range of the particle as measured in the EMR, and the momentum measured in the downstream Tracker.
PIDVarG	EMRPlaneDensity	Uses the plane hit density in the EMR. This variable is beam dependent, and so is best used during offline data analysis.
PIDVarH	EMRPlaneDensityvsDSTrackerMom	Uses the plane hit density in the EMR, and the momentum measured in the downstream Tracker.
PIDVarI	CkovAvsUSTrackerMom	Uses the number of photoelectrons in Cherenkov A, and the momentum measured in the upstream Tracker.
PIDVarJ	CkovBvsUSTrackerMom	Uses the number of photoelectrons in Cherenkov B, and the momentum measured in the upstream Tracker.

Adding PID Variables

In each derived variable class, the following should be included:

- The variable name should be set
- The function to calculate the PID variable should be defined.
- If a valid value of a variable is not returned by the function, for instance due to missing measurements, then the value should be set to -1 so that it falls outside of the range of any PDFs.
- The minimum, maximum, and number of bins for PDFs created using the variable should be set. The values of the minimum and maximum define the allowed range of values that the PID variable can take.
- In some cases it may be necessary to ensure that all bins in a PDF return non zero entries, and so by setting the variable `_nonZeroHistEntries` to true, a single event spread accross all bins will be added

Placing cuts on PIDVar value ranges

A further option for users when performing PID against the PDFs, is to cut on what range of values within the PDFs to perform PID within. This may allow for greater purity (potentially at the expense of efficiency) depending on the variable. For instance, one could choose to cut harshly on the time of flight in PIDVarA, to reduce the chances of mis-identifying pions as muons. These cuts can be selected through setting the appropriate `pid_` bounds datacards found in `ConfigurationDefaults.py`.

Chapter 14

Accessing Global Tracks

The global datastructure is set up so that the state of tracks at any point in the processing chain, import, track matching, pid, and track fitting, can easily be accessed in order to understand where a given track came from and what lead to its current state.

To achieve this, tracks are packaged together in `PrimaryChain` objects which retain copies of the tracks at every step along the way. There will generally be one primary chain for every tracker track that has been matched to at least one additional detector, plus possible through primary chains for tracks that have been matched through the absorber.

14.1 The PrimaryChain Object

A primary chain (`MAUS::DataStructure::Global::PrimaryChain`) has a number of member functions for accessing parameters describing the chain as well as the variety of tracks that are contained in it:

get_chain_type() A chain can hold either upstream tracks, downstream tracks, or through tracks. The chain type is an enumerator with the following values

kNoChainType Used for initialization only

kUS A chain containing upstream tracks. This value furthermore implies that a track in the chain has been matched into a through chain.

kDS A chain containing downstream tracks. This value furthermore implies that a track in the chain has been matched into a through chain.

kUSOrphan A chain containing upstream tracks none of which has been matched into a through track

kDSOrphan A chain containing downstream tracks none of which has been matched into a through track

kThrough A chain containing through tracks. It will also reference daughter upstream and downstream chains

get_chain_multiplicity This is only a meaningful property for through chains. It describes whether this and another through chain are mutually exclusive because they share daughter chains, for example if the same upstream track has been matched to multiple downstream tracks. The possible values of the enumerator are

kUnique This chain does not share daughter chains with any other through chains

kMultipleUS This chain shares an upstream chain with at least one other through chain

kMultipleDS This chain shares a downstream chain with at least one other through chain

kMultipleBoth This chain shares both its upstream and downstream chains with other through chains

Note that constellations are possible where e.g. there are 3 chains, one of type `kMultipleUS`, one of type `kMultipleDS`, and the last of type `kMultipleBoth`.

get_mapper_name() The name of the mapper that last modified this primary chain object.

GetUSDaughter() For a through chain returns the upstream daughter chain.

GetDSDaughter() For a through chain returns the downstream daughter chain.

GetMatchedTracks() Returns a vector of all matched tracks for this chain. There is not a single matched track since as described in section `refsec:tmprocess`, tracks for all feasible PID hypotheses have to be created.

GetPIDTrack() Returns the PID'd track (if one exists in the chain).

GetFittedTrack() Returns the fitted track (if one exists in the chain).

Note that the global track object also holds references to constituent tracks, so there are two different ways one could obtain upstream and downstream tracks from a through primary chain. For example to obtain PID'd tracks:

```
through_chain->GetPIDTrack()->GetConstituentTracks()
```

or

```
through_chain->GetUSDaughter()->GetPIDTrack()  
through_chain->GetDSDaughter()->GetPIDTrack()
```

14.1.1 Identifying Decay Candidates

Primary chains also allow identifying events that may contain a $\pi \rightarrow \mu$ or $\mu \rightarrow e$ decay. If an upstream and downstream track come out of Particle ID with different PIDs, no PID'd through track can be created, so an existing through chain will return NULL from `through_chain->GetPIDTrack()`. In this case, a decay candidate can be identified e.g. by testing that

```
through_chain->GetUSDaughter()->GetPIDTrack()->get_pid()  
== MAUS::DataStructure::Global::kPiPlus
```

and

```
through_chain->GetDSDaughter()->GetPIDTrack()->get_pid()  
== MAUS::DataStructure::Global::kMuPlus
```

Additional candidates could be identified from orphan chains, but caution is advised, as there is a good chance these might be from different particles rather than decays.

14.2 Tracks and Space Points from Local Reconstruction

While tracks and space points from the local reconstruction which have ended up in matched tracks can be accessed as constituent tracks of matched tracks and as space points linked to by the track points in matched tracks, there might be a need to access all tracks and spacepoints from local reconstruction, including those that were not successfully matched. Since they can't be associated with a primary chain, they can be accessed directly from the global event via

```
std::vector<MAUS::DataStructure::Global::Track*> GetLRTracks()  
std::vector<MAUS::DataStructure::Global::Track*>  
    GetLRTracks(MAUS::DataStructure::Global::DetectorPoint detector)
```

and

```
std::vector<MAUS::DataStructure::Global::SpacePoint*> GetLRSpacePoints()  
std::vector<MAUS::DataStructure::Global::SpacePoint*>  
    GetLRSpacePoints(MAUS::DataStructure::Global::DetectorPoint detector)
```

where the optional argument `detector` allows specifying from which detectors tracks or space points should be retrieved.

Chapter 15

The Envelope Tool

The MAUS envelope tool is intended as a tool to support lattice development and enable visualisation of the MICE accelerator for online use. The tool facilitates the visualisation of field elements, propagation of particles and beams ellipses through those elements.

The envelope tool is intended for use with mostly straight beamlines.

15.1 Example Usage

To call the envelope tool with some example data, source the MAUS environment and then do

```
$ python ${MAUS_ROOT_DIR}/bin/utilities/envelope_tool/envelope_tool.py \  
--configuration_file ${MAUS_ROOT_DIR}/bin/utilities/envelope_tool/share/pseudobeamline.py
```

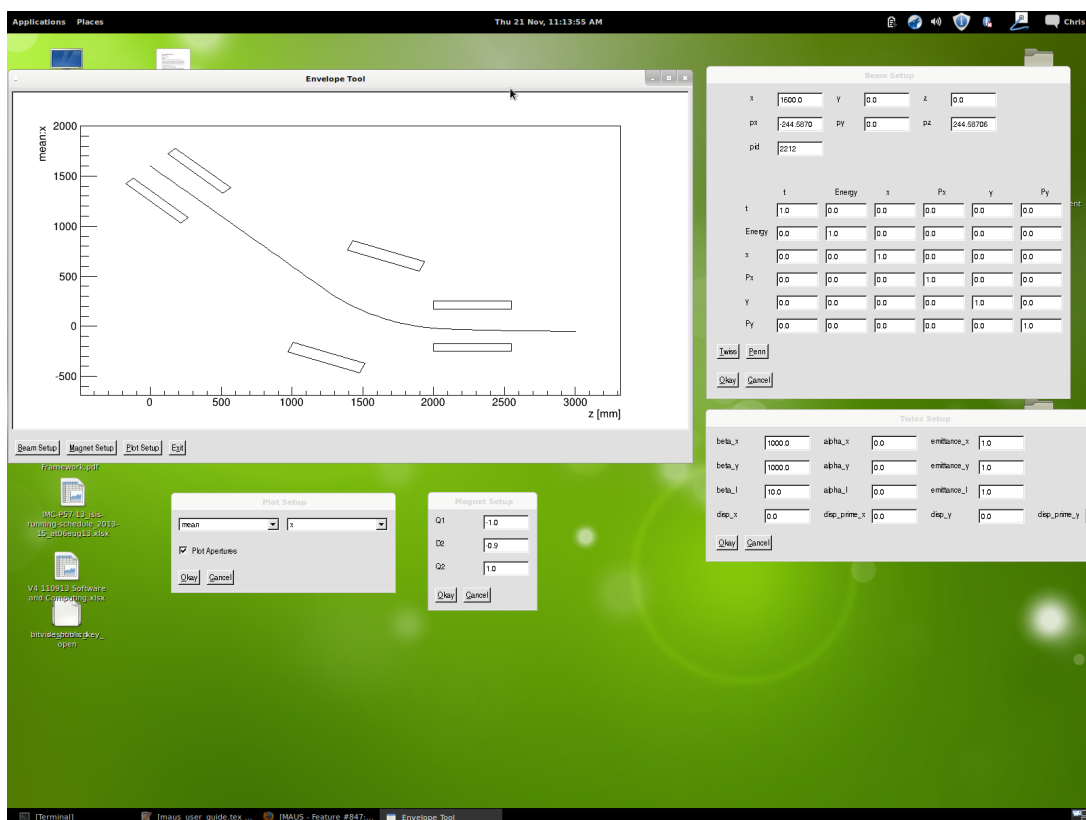

Figure 15.1: The Envelope Tool used to plot a reference trajectory through a few magnets.

15.2 Envelope Tool main window

The Main Window enables the user to view the selected lattice parameters, and provides buttons to update the beam, lattice and plot parameters.

- Beam Setup: setup a beam
- Magnet Setup: setup fields
- Plot Setup: setup the plot
- Exit: exit the GUI

15.3 Beam Setup

The Beam Setup window enables the user to set beam parameters. The top few cells set initial position, momentum and particle type of the beam centroid, also referred to as the ‘reference particle’ or ‘reference trajectory’. The bottom few cells set beam ellipse parameters.

Helper windows can be accessed to parameterise the beam ellipse using either a Penn parameterisation or a Twiss parameterisation.

- x, y, z: initial position of the beam particle
- px, py, pz: initial momentum of the beam particle
- pid: PDG ID of the beam particle. This is an integer; see Tab. ?? for some common particle ids.
- ellipse elements: set the elements of the beam ellipse. The matrix must be symmetric and positive definite or an error will be returned when Okay is pressed.
- Twiss: setup the beam using a Twiss parameterisation - beam asymmetric in x and y with no coupling
- Penn: setup the beam using a Penn parameterisation - beam cylindrically symmetric in x and y with angular momentum
- Okay: click okay to return to the main window, updating the beam ellipse
- Cancel: click cancel to return to the main window, losing changes

15.4 Magnet Setup

The user can manipulate magnet parameters in this window. When the window is opened, MiceModules which have the following required parameters are added to the window.

- FieldType (string)
- FieldName (string)
- Position (hep three vector)
- Rotation (hep three vector)
- ScaleFactor (double)
- NominalAperture (hep three vector)
- NominalOuter (hep three vector)

Other MiceModules will be ignored.

Each magnet is labelled with the magnet FieldName and a text entry is available to set the scale factor (proportional to field).

- <field entries>: Enter a float to set the scale factor.
- Okay: Update the fields in the lattice
- Cancel: Cancel changes

15.5 Plot Setup

The Plot Setup window enables the user to select the desired plot parameters.

- Plot Type: Select the type of variable to plot.
- Plot Variable: Select the variable to plot.
- Plot Apertures: tick to plot physical apertures. If the plot type is **mean** or **envelope** and plot variable is **x** or **y** the apertures will be plotted as a 2D projection of the physical apertures in the appropriate plane, with the beam reference trajectory or beam envelope superimposed. Note that the rotations applied here are rather simplistic, assuming a 2D geometry in x or y plane (but not both) Otherwise nominal apertures will be scaled to fit in the upper portion of the plotting window.
- Okay: Update the plot in the main window with the new selection.
- Cancel: Cancel changes

Chapter 16

G4beamline-MAUS Integration

This chapter describes how to run G4beamline as a third-party app with MAUS. G4beamline is used to model the MICE beam line from the target to a point upstream of the second quad triplet (upstream of Q4). It provides a realistic beam description which can be used to seed downstream simulations in MAUS. To generate MAUS primaries with G4beamline the script `simulate_mice_G4BL.py` is used instead of the usual `simulate_mice.py` script. The beam line settings can be controlled with the dictionary `g4bl` (table 16.1) in the MAUS datacard.

The default configuration variables simulate a 6π 200 MeV/c positive beam using a point 1 m downstream of D2 as the interface point. This can be used as input for the MAUS Step IV geometry provided by the Geometry group. To generate MAUS primaries for beams of different momenta or at difference interfaces (i.e. for different MAUS geometries) these variables must be changed accordingly.

The output of this mapper is a json document of MAUS primaries. This is passed directly to MapCppSimulation and so simulations of the entire MICE beam line from end-to-end can be run. However given the requisite time required to complete such a simulation this is not recommended. Large scale production jobs will be run on the Grid using this mapper to create beam libraries. These are publically available from http://www.ppe.gla.ac.uk/~jnugent/Grid_Files/. Download the relevant beam file which will contain a list of Grid addresses for files stored on a Grid storage element (SE). You will be required to either run a Grid job to access these files or pull them from the SE to your local area to work on them. For information on working with the Grid see <https://www.gridpp.ac.uk/php/support/otherScihelp.php#3>.

The output json document from this mapper is called `G4BLoutput.json` and is written in whichever directory `simulate_mice_G4BL.py` was run. To run MAUS using this file as input the script `simulate_beam.py` can be used. The path to `G4BLoutput.json` must be set in the MAUS datacard using the variable `input_json_file_name`.

Table 16.1: G4BL parameters

<i>MAUS will write the following variables to the G4BL configuration file</i>	
q_1, q_2, q_3, d_1, d_s, d_2	Field gradient of magnet
particles_per_spill	No. of particles to take out of buffer for each spill, if set to zero then all particles are taken from buffer for first spill
run_number	When retrieving magnet currents and proton absorber thickness from CDB set to the run number of interest
rotation_angle	Rotation of MAUS co-ordinate system clockwise around the y-axis with respect to G4BL co-ordinate system
translation_z	The distance between the MAUS centre and the G4BL centre. It assumes the G4BL centre is in front of the MAUS centre
proton_absorber_thickness	Thickness of the proton absorber
proton_number	No. of protons on target in G4BL
proton_weight	Scales the number of protons generated, with default setting protons are NOT generated
particle_charge	Refers to the charge of the simulated particles. Can be set to, positive-only, negative-only or all
file_path	Path to G4BL input
get_magnet_currents_pa_cdb	If set to True all magnet currents and proton absorber thickness will be retrieved from the CDB and written to the G4BL configuration file for the run number given in this dictionary
random_seed	Sets the random seed for G4beamline

Chapter 17

Appendix C: Tracker Appendices

17.1 Kuno's Conjecture

For a given triplet space-point, the sum of the channel number of each cluster will be a constant.

To see how this comes about, consider the coordinate system defined by the u , v and w axes in the station reference frame shown in figure 17.1. The u , v and w coordinates may be written in terms of the polar coordinates (r, ϕ) as follows:

$$u = r \cos[\phi] \quad (17.1)$$

$$v = r \cos\left[\frac{2\pi}{3} - \phi\right] \quad (17.2)$$

$$w = r \cos\left[\frac{4\pi}{3} - \phi\right] \quad (17.3)$$

The sum $u + v + w$ may now be written:

$$u + v + w = r \left\{ \cos \phi + \cos\left[\frac{2\pi}{3} - \phi\right] + \cos\left[\frac{4\pi}{3} - \phi\right] \right\} \quad (17.4)$$

$$= r \left\{ \cos \phi + \left[\cos\left(\frac{2\pi}{3}\right) \cos \phi + \sin\left(\frac{2\pi}{3}\right) \sin \phi \right] + \right. \quad (17.5)$$

$$\left. \left[\cos\left(-\frac{2\pi}{3}\right) \cos \phi + \sin\left(-\frac{2\pi}{3}\right) \sin \phi \right] \right\} \quad (17.6)$$

$$= r \left\{ \cos \phi + 2 \cos\left(\frac{2\pi}{3}\right) \cos \phi \right\} \quad (17.7)$$

$$= r \{ \cos \phi + [-\cos \phi] \} \quad (17.8)$$

$$= 0 \quad (17.9)$$

If the sum is performed using the fibre numbers for the channels hit, the sum of the the three views will equal the sum of the central-fibre numbers, i.e. if the central fibre numbers of each of the u , v and w doublet-layers is 106.5, then the sum of channel numbers will be $106.5 + 106.5 + 105.5 = 318.5$.

17.2 Space-point variance

Figure 11.9 shows the arrangement of the fibre channels in the tracker. The regions in which a space point will be reconstructed are shown by the shaded areas. The area of the triangular intersection is given by:

$$A = 4 \frac{1}{2} \frac{c_p}{\sqrt{3}} \frac{c_p}{2} \quad (17.10)$$

$$= \frac{c_p^2}{\sqrt{3}}; \quad (17.11)$$

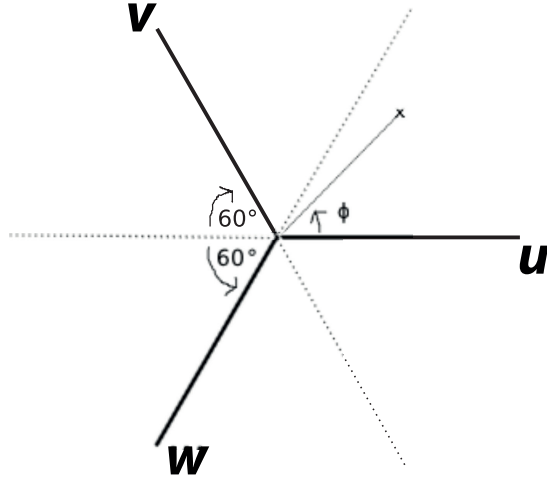

Figure 17.1: Schematic representation of a point and the three plane orientations.

where c_p is the channel pitch. Therefore, for the triangular intersection, the mean values of x and y are given by:

$$\bar{x} = \frac{1}{A} \int \int x dx dy \quad (17.12)$$

$$= \frac{1}{A} \int_0^{c_p} x dx \int_{-\frac{x}{\sqrt{3}}}^{\frac{x}{\sqrt{3}}} dy \quad (17.13)$$

$$= \frac{1}{A} \frac{2}{\sqrt{3}} \int_0^{c_p} x^2 dx \quad (17.14)$$

$$= \frac{1}{A} \frac{2}{\sqrt{3}} \frac{c_p^3}{3} \quad (17.15)$$

$$= \frac{\sqrt{3}}{c_p^2} \frac{2}{\sqrt{3}} \frac{c_p^3}{3} \quad (17.16)$$

$$= \frac{2}{3} c_p ; \text{ and} \quad (17.17)$$

$$\bar{y} = \frac{1}{A} \int \int y dx dy \quad (17.18)$$

$$= \frac{1}{A} \int_0^{c_p} dx \int_{-\frac{x}{\sqrt{3}}}^{\frac{x}{\sqrt{3}}} y dy \quad (17.19)$$

$$= \frac{1}{A} \int_0^{c_p} \left[\frac{y^2}{2} \right]_{-\frac{x}{\sqrt{3}}}^{\frac{x}{\sqrt{3}}} dx \quad (17.20)$$

$$= 0. \quad (17.21)$$

The variance of the x and y coordinates are then given by:

$$V_x = \sigma_x^2 = \frac{1}{A} \int \int (x - \bar{x})^2 dx dy \quad (17.22)$$

$$= \frac{1}{A} \int_0^{c_p} dx \int_{-\frac{x}{\sqrt{3}}}^{\frac{x}{\sqrt{3}}} (x - \bar{x})^2 dy \quad (17.23)$$

$$= \frac{1}{A} \frac{2}{\sqrt{3}} \int_0^{c_p} x(x - \bar{x})^2 dx \quad (17.24)$$

$$= \frac{1}{A} \frac{2}{\sqrt{3}} \int_0^{c_p} (x^3 - 2x^2\bar{x} + \bar{x}^2x) dx \quad (17.25)$$

$$= \frac{1}{A} \frac{2}{\sqrt{3}} \int_0^{c_p} \left(x^3 - \frac{4}{3}c_p x^2 + \frac{4}{9}c_p^2 x \right) dx \quad (17.26)$$

$$= \frac{1}{A} \frac{2}{\sqrt{3}} \left[\frac{x^4}{4} - \frac{4}{9}c_p x^3 + \frac{2}{9}c_p^2 x^2 \right]_0^{c_p} \quad (17.27)$$

$$= \frac{c_p^4}{A} \frac{2}{\sqrt{3}} \left[\frac{1}{4} - \frac{4}{9} + \frac{2}{9} \right] \quad (17.28)$$

$$= \frac{c_p^4}{A} \frac{2}{\sqrt{3}} \left[\frac{1}{4} - \frac{2}{9} \right] \quad (17.29)$$

$$= c_p^4 \frac{\sqrt{3}}{c_p^2} \frac{2}{\sqrt{3}} \frac{1}{36} \quad (17.30)$$

$$= \frac{1}{18} c_p^2 \quad (17.31)$$

$$V_x = \sigma_x^2 = \left(\frac{c_p}{3\sqrt{2}} \right)^2 ; \quad (17.32)$$

$$V_y = \sigma_y^2 = \frac{1}{A} \int_0^{c_p} dx \int_{-\frac{x}{\sqrt{3}}}^{\frac{x}{\sqrt{3}}} (y - \bar{y})^2 dy \quad (17.33)$$

$$= \frac{1}{A} \int_0^{c_p} \left[\frac{y^3}{3} \right]_{-\frac{x}{\sqrt{3}}}^{\frac{x}{\sqrt{3}}} dy \quad (17.34)$$

$$= \frac{1}{A} \frac{2}{3\sqrt{3}} \int_0^{c_p} x^3 dx$$

$$= \frac{1}{A} \frac{2}{9\sqrt{3}} \left[\frac{x^4}{4} \right]_0^{c_p} \quad (17.35)$$

$$= \frac{1}{A} \frac{2}{9\sqrt{3}} \frac{c_p^4}{4} \quad (17.36)$$

$$= \frac{\sqrt{3}}{c_p^2} \frac{2}{9\sqrt{3}} \frac{c_p^4}{4} \quad (17.37)$$

$$= \frac{1}{9} \frac{c_p^2}{2} \quad (17.38)$$

$$= \frac{1}{18} c_p^2 \quad (17.39)$$

$$V_y = \sigma_y^2 = \left(\frac{c_p}{3\sqrt{2}} \right)^2 . \quad (17.40)$$

The covariance is given by:

$$V_{xy} = \frac{1}{A} \int \int (x - \bar{x})(y - \bar{y}) dx dy \quad (17.41)$$

$$= \frac{1}{A} \int_0^{c_p} (x - \bar{x}) dx \int_{-\frac{x}{\sqrt{3}}}^{\frac{x}{\sqrt{3}}} (y - \bar{y}) dy \quad (17.42)$$

$$= \frac{1}{A} \int_0^{c_p} (x - \bar{x}) \left[\frac{1}{2} y^2 - y\bar{y} \right]_{-\frac{x}{\sqrt{3}}}^{\frac{x}{\sqrt{3}}} \quad (17.43)$$

$$= 0. \quad (17.44)$$

Therefore:

$$\sigma_x = \sigma_y = \frac{c_p}{3\sqrt{2}} = 384.4 \mu\text{m}. \quad (17.45)$$

For the hexagonal case, the area of the overlapping region (shaded zone in the right panel of figure 11.9) is given by:

$$A = 6 \frac{1}{2} \frac{c_p}{\sqrt{3}} \frac{c_p}{2} \quad (17.46)$$

$$= \frac{\sqrt{3}}{2} c_p^2. \quad (17.47)$$

By symmetry, $\bar{x} = \bar{y} = 0$. The variance of the x and y coordinates are given by:

$$V_x = \sigma_x^2 = \sigma_y^2 = \frac{1}{A} \int \int (x - \bar{x})^2 dx dy \quad (17.48)$$

$$= \frac{1}{A} \int \int x^2 dx dy \quad (17.49)$$

$$= \frac{2}{A} \int_{-\frac{c_p}{2}}^0 x^2 dx \int_{-\frac{x}{\sqrt{3}} - \frac{c_p}{\sqrt{3}}}^{\frac{x}{\sqrt{3}} + \frac{c_p}{\sqrt{3}}} dy \quad (17.50)$$

$$= \frac{2}{A} \int_{-\frac{c_p}{2}}^0 x^2 \left[2 \left(\frac{x}{\sqrt{3}} + \frac{c_p}{\sqrt{3}} \right) \right] dx \quad (17.51)$$

$$= \frac{2}{A} \frac{2}{\sqrt{3}} \int_{-\frac{c_p}{2}}^0 (x^3 + x^2 c_p) dx \quad (17.52)$$

$$= \frac{2}{A} \frac{2}{\sqrt{3}} \left[\frac{1}{4} x^4 + \frac{1}{3} x^3 c_p \right]_{-\frac{c_p}{2}}^0 \quad (17.53)$$

$$= \frac{2}{A} \frac{2}{\sqrt{3}} \left[\frac{1}{8} \left(\frac{1}{3} - \frac{1}{8} \right) c_p^4 \right] \quad (17.54)$$

$$= \frac{2}{\sqrt{3} c_p^2} \frac{5}{48\sqrt{3}} c_p^4 = \frac{1}{\sqrt{3}} \frac{5}{48\sqrt{3}} c_p^2 \quad (17.55)$$

$$= \left(\sqrt{\frac{5}{2}} \frac{c_p}{6} \right)^2. \quad (17.56)$$

As before, the covariance is given by:

$$V_{xy} = \frac{1}{A} \int \int (x - \bar{x})(y - \bar{y}) dx dy \quad (17.57)$$

$$\begin{aligned} &= \frac{2}{A} \int_{-\frac{c_p}{2}}^0 x dx \int_{-\frac{x}{\sqrt{3}} - \frac{c_p}{\sqrt{3}}}^{\frac{x}{\sqrt{3}} + \frac{c_p}{\sqrt{3}}} y dy \\ &= \frac{2}{A} \int_{-\frac{c_p}{2}}^0 x dx \left[\frac{1}{2} y^2 \right]_{-\frac{x}{\sqrt{3}} - \frac{c_p}{\sqrt{3}}}^{\frac{x}{\sqrt{3}} + \frac{c_p}{\sqrt{3}}} \\ &= 0. \end{aligned} \quad (17.58)$$

Therefore:

$$\sigma_x = \sigma_y = \sqrt{\frac{5}{2}} \frac{c_p}{6} = 429.8 \mu\text{m}. \quad (17.59)$$

17.3 Circle parameters from three points

A circle in the plane $z = 0$ may be parameterised as:

$$(x - X_0)^2 + (y - Y_0)^2 = \rho^2; \quad (17.60)$$

where (X_0, Y_0) is the position of the centre of the circle and ρ is its radius. Expanding:

$$(x^2 + y^2) - 2X_0x - 2Y_0y = \rho^2 - (X_0^2 + Y_0^2); \quad (17.61)$$

which implies:

$$\frac{(x^2 + y^2)}{\rho^2 - (X_0^2 + Y_0^2)} - \frac{2X_0x}{\rho^2 - (X_0^2 + Y_0^2)} - \frac{2Y_0y}{\rho^2 - (X_0^2 + Y_0^2)} = 1. \quad (17.62)$$

The circle may be parameterised:

$$\alpha(x^2 + y^2) + \beta x + \gamma y + \kappa = 0; \quad (17.63)$$

where:

$$\alpha = \frac{1}{\rho^2 - (X_0^2 + Y_0^2)}; \quad (17.64)$$

$$\beta = -2X_0\alpha; \quad (17.65)$$

$$\gamma = -2Y_0\alpha; \quad (17.66)$$

$$\kappa = -1. \quad (17.67)$$

These equations are readily inverted to yield:

$$X_0 = \frac{-\beta}{2\alpha}; \quad (17.68)$$

$$Y_0 = \frac{-\gamma}{2\alpha}; \quad (17.69)$$

$$\rho = \sqrt{\frac{\beta^2 + \gamma^2}{4\alpha^2} - \frac{\kappa}{\alpha}}. \quad (17.70)$$

The equation of a circle passing through three points (x_i, y_i) , where $i = 1, 2, 3$ can be found from:

$$\begin{vmatrix} x^2 + y^2 & x & y & 1 \\ x_1^2 + y_1^2 & x_1 & y_1 & 1 \\ x_2^2 + y_2^2 & x_2 & y_2 & 1 \\ x_3^2 + y_3^2 & x_3 & y_3 & 1 \end{vmatrix} = 0; \quad (17.71)$$

which can be re-written as:

$$(x^2 + y^2) \begin{vmatrix} x_1 & y_1 & 1 \\ x_2 & y_2 & 1 \\ x_3 & y_3 & 1 \end{vmatrix} - x \begin{vmatrix} x_1^2 + y_1^2 & y_1 & 1 \\ x_2^2 + y_2^2 & y_2 & 1 \\ x_3^2 + y_3^2 & y_3 & 1 \end{vmatrix} + y \begin{vmatrix} x_1^2 + y_1^2 & x_1 & 1 \\ x_2^2 + y_2^2 & x_2 & 1 \\ x_3^2 + y_3^2 & x_3 & 1 \end{vmatrix} - \begin{vmatrix} x_1^2 + y_1^2 & x_1 & y_1 \\ x_2^2 + y_2^2 & x_2 & y_2 \\ x_3^2 + y_3^2 & x_3 & y_3 \end{vmatrix} = 0. \quad (17.72)$$

Comparing this relation with equation 17.63:

$$\alpha = \begin{vmatrix} x_1 & y_1 & 1 \\ x_2 & y_2 & 1 \\ x_3 & y_3 & 1 \end{vmatrix} \quad (17.73)$$

$$\beta = - \begin{vmatrix} x_1^2 + y_1^2 & y_1 & 1 \\ x_2^2 + y_2^2 & y_2 & 1 \\ x_3^2 + y_3^2 & y_3 & 1 \end{vmatrix} \quad (17.74)$$

$$\gamma = \begin{vmatrix} x_1^2 + y_1^2 & x_1 & 1 \\ x_2^2 + y_2^2 & x_2 & 1 \\ x_3^2 + y_3^2 & x_3 & 1 \end{vmatrix} \quad (17.75)$$

$$\kappa = - \begin{vmatrix} x_1^2 + y_1^2 & x_1 & y_1 \\ x_2^2 + y_2^2 & x_2 & y_2 \\ x_3^2 + y_3^2 & x_3 & y_3 \end{vmatrix}. \quad (17.76)$$

Noting that:

$$\left(x + \frac{\beta}{2\alpha}\right)^2 + \left(y + \frac{\gamma}{2\alpha}\right)^2 = \left(\sqrt{\frac{\beta^2 + \gamma^2}{4\alpha^2} - \frac{\kappa}{\alpha}}\right)^2. \quad (17.77)$$

the position of the centre of the circle, (X_0, Y_0) and its radius, ρ , are given by equations 17.68 to 17.70.

17.4 Helical Track Pattern Recognition

The equation of motion of a charged particle in an external magnetic field can be written as

$$\frac{d^2x}{ds^2} = \frac{q}{p} \left(\frac{d\vec{x}}{ds}\right) \times \vec{B}(s) \quad (17.78)$$

If we assume that the magnetic field lies along the z axis $\vec{B} = (0, 0, B)$, then the three scalar components of it can be written as

$$\begin{aligned} \frac{d^2x}{ds^2} &= \frac{q}{P} \left(\frac{dy}{ds}\right) B \\ \frac{d^2y}{ds^2} &= -\frac{q}{P} \left(\frac{dx}{ds}\right) B \\ \frac{d^2z}{ds^2} &= 0 \end{aligned} \quad (17.79)$$

we also note that P is the total momentum and the transverse momentum $p_t = P \cos \lambda = qBR_H$ can be written as

$$\begin{aligned} p_x &= p_t \cos \phi \\ p_y &= -p_t \sin \phi \end{aligned} \quad (17.80)$$

the solution of the above equations will be a helix

$$\begin{aligned} x(s) &= x_1 + R \left[\cos \left(\Phi_0 + \frac{hs \cos \lambda}{R} \right) - \cos \Phi_0 \right] \\ y(s) &= y_1 + R \left[\sin \left(\Phi_0 + \frac{hs \cos \lambda}{R} \right) - \sin \Phi_0 \right] \\ z(s) &= z_1 + s \sin \lambda \end{aligned} \quad (17.81)$$

where x_1, y_1 and z_1 is the starting point. R is the radius of the helix. $h = \pm 1$ is the sense of the rotation in $x - y$ plane. We note that

$$\begin{aligned} ds^2 &= dx^2 + dy^2 + dz^2 \\ ds/dz &= (1 + \dot{x}^2 + \dot{y}^2)^{1/2} \\ \left(\frac{dx}{ds}\right)^2 + \left(\frac{dy}{ds}\right)^2 + \left(\frac{dz}{ds}\right)^2 &= 1 \end{aligned} \quad (17.82)$$

On the other hand, the equation of a circle passing through three space points (x_i, y_i) , where $i = 1, 2, 3$ can be found from the following determinant.

$$\begin{vmatrix} x^2 + y^2 & x & y & 1 \\ x_1^2 + y_1^2 & x_1 & y_1 & 1 \\ x_2^2 + y_2^2 & x_2 & y_2 & 1 \\ x_3^2 + y_3^2 & x_3 & y_3 & 1 \end{vmatrix} = 0 \quad (17.83)$$

which can be re-written as

$$(x^2 + y^2) \begin{vmatrix} x_1 & y_1 & 1 \\ x_2 & y_2 & 1 \\ x_3 & y_3 & 1 \end{vmatrix} - x \begin{vmatrix} x_1^2 + y_1^2 & y_1 & 1 \\ x_2^2 + y_2^2 & y_2 & 1 \\ x_3^2 + y_3^2 & y_3 & 1 \end{vmatrix} + y \begin{vmatrix} x_1^2 + y_1^2 & x_1 & 1 \\ x_2^2 + y_2^2 & x_2 & 1 \\ x_3^2 + y_3^2 & x_3 & 1 \end{vmatrix} - \begin{vmatrix} x_1^2 + y_1^2 & x_1 & y_1 \\ x_2^2 + y_2^2 & x_2 & y_2 \\ x_3^2 + y_3^2 & x_3 & y_3 \end{vmatrix} = 0 \quad (17.84)$$

comparing the above relation with the conventional circle equation

$$a(x^2 + y^2) + dx + ey + f = 0 \quad (17.85)$$

or

$$\left(x + \frac{d}{2a}\right)^2 + \left(y + \frac{e}{2a}\right)^2 = \left(\sqrt{\frac{d^2 + e^2}{4a^2} - \frac{f}{a}}\right)^2 \quad (17.86)$$

we find that

$$a = \begin{vmatrix} x_1 & y_1 & 1 \\ x_2 & y_2 & 1 \\ x_3 & y_3 & 1 \end{vmatrix} \quad (17.87)$$

$$d = - \begin{vmatrix} x_1^2 + y_1^2 & y_1 & 1 \\ x_2^2 + y_2^2 & y_2 & 1 \\ x_3^2 + y_3^2 & y_3 & 1 \end{vmatrix} \quad (17.88)$$

$$e = \begin{vmatrix} x_1^2 + y_1^2 & x_1 & 1 \\ x_2^2 + y_2^2 & x_2 & 1 \\ x_3^2 + y_3^2 & x_3 & 1 \end{vmatrix} \quad (17.89)$$

$$f = - \begin{vmatrix} x_1^2 + y_1^2 & x_1 & y_1 \\ x_2^2 + y_2^2 & x_2 & y_2 \\ x_3^2 + y_3^2 & x_3 & y_3 \end{vmatrix} \quad (17.90)$$

and also the centre and the radius of the circle will be

$$\begin{aligned} x_0 &= -\frac{d}{2a} \\ y_0 &= -\frac{e}{2a} \\ R &= \sqrt{\frac{d^2 + e^2}{4a^2} - \frac{f}{a}} \end{aligned} \quad (17.91)$$